

HEXFET® Power MOSFET

- Dynamic dv/dt Rating
- Repetitive Avalanche Rated
- Fast Switching
- Ease of Paralleling
- Simple Drive Requirements

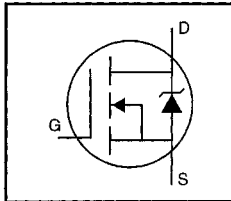

$$V_{DSS} = 200V$$

$$R_{DS(on)} = 0.18\Omega$$

$$I_D = 18A$$

Description

Third Generation HEXFETs from International Rectifier provide the designer with the best combination of fast switching, ruggedized device design, low on-resistance and cost-effectiveness.

The TO-220 package is universally preferred for all commercial-industrial applications at power dissipation levels to approximately 50 watts. The low thermal resistance and low package cost of the TO-220 contribute to its wide acceptance throughout the industry.

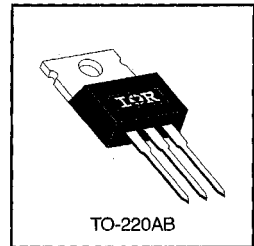
 DATA
SHEETS

Absolute Maximum Ratings

	Parameter	Max.	Units
$I_D @ T_C = 25^\circ C$	Continuous Drain Current, $V_{GS} @ 10V$	18	A
$I_D @ T_C = 100^\circ C$	Continuous Drain Current, $V_{GS} @ 10V$	11	
	I_{DM} Pulsed Drain Current ①	72	
$P_D @ T_C = 25^\circ C$	Power Dissipation	125	W
	Linear Derating Factor	1.0	W/°C
V_{GS}	Gate-to-Source Voltage	± 20	V
E_{AS}	Single Pulse Avalanche Energy ②	580	mJ
I_{AR}	Avalanche Current ①	18	A
E_{AR}	Repetitive Avalanche Energy ①	13	mJ
dv/dt	Peak Diode Recovery dv/dt ③	5.0	V/ns
T_J	Operating Junction and	-55 to +150	°C
T_{STG}	Storage Temperature Range		
	Soldering Temperature, for 10 seconds		
	Mounting Torque, 6-32 or M3 screw	10 lbf·in (1.1 N·m)	

Thermal Resistance

	Parameter	Min.	Typ.	Max.	Units
$R_{\theta JC}$	Junction-to-Case	—	—	1.0	°C/W
$R_{\theta CS}$	Case-to-Sink, Flat, Greased Surface	—	0.50	—	
$R_{\theta JA}$	Junction-to-Ambient	—	—	62	

Electrical Characteristics @ $T_J = 25^\circ\text{C}$ (unless otherwise specified)

	Parameter	Min.	Typ.	Max.	Units	Test Conditions
$V_{(BR)DSS}$	Drain-to-Source Breakdown Voltage	200	—	—	V	$V_{GS}=0\text{V}$, $I_D=250\mu\text{A}$
$\Delta V_{(BR)DSS}/\Delta T_J$	Breakdown Voltage Temp. Coefficient	—	0.29	—	$\text{V}/^\circ\text{C}$	Reference to 25°C , $I_D=1\text{mA}$
$R_{DS(on)}$	Static Drain-to-Source On-Resistance	—	—	0.18	Ω	$V_{GS}=10\text{V}$, $I_D=11\text{A}$ ④
$V_{GS(th)}$	Gate Threshold Voltage	2.0	—	4.0	V	$V_{DS}=V_{GS}$, $I_D=250\mu\text{A}$
g_{fs}	Forward Transconductance	6.7	—	—	S	$V_{DS}=50\text{V}$, $I_D=11\text{A}$ ④
I_{DSS}	Drain-to-Source Leakage Current	—	—	25	μA	$V_{DS}=200\text{V}$, $V_{GS}=0\text{V}$
		—	—	250		$V_{DS}=160\text{V}$, $V_{GS}=0\text{V}$, $T_J=125^\circ\text{C}$
I_{GSS}	Gate-to-Source Forward Leakage	—	—	100	nA	$V_{GS}=20\text{V}$
	Gate-to-Source Reverse Leakage	—	—	-100		$V_{GS}=-20\text{V}$
Q_g	Total Gate Charge	—	—	70	nC	$I_D=18\text{A}$
Q_{gs}	Gate-to-Source Charge	—	—	13		$V_{DS}=160\text{V}$
Q_{gd}	Gate-to-Drain ("Miller") Charge	—	—	39		$V_{GS}=10\text{V}$ See Fig. 6 and 13 ④
$t_{d(on)}$	Turn-On Delay Time	—	14	—	ns	$V_{DD}=100\text{V}$
t_r	Rise Time	—	51	—		$I_D=18\text{A}$
$t_{d(off)}$	Turn-Off Delay Time	—	45	—		$R_G=9.1\Omega$
t_f	Fall Time	—	36	—		$R_D=5.4\Omega$ See Figure 10 ④
L_D	Internal Drain Inductance	—	4.5	—	nH	Between lead, 6 mm (0.25in.) from package and center of die contact
L_S	Internal Source Inductance	—	7.5	—		
C_{iss}	Input Capacitance	—	1300	—	pF	$V_{GS}=0\text{V}$
C_{oss}	Output Capacitance	—	430	—		$V_{DS}=25\text{V}$
C_{rss}	Reverse Transfer Capacitance	—	130	—		$f=1.0\text{MHz}$ See Figure 5



Source-Drain Ratings and Characteristics

	Parameter	Min.	Typ.	Max.	Units	Test Conditions
I_S	Continuous Source Current (Body Diode)	—	—	18	A	MOSFET symbol showing the integral reverse p-n junction diode.
I_{SM}	Pulsed Source Current (Body Diode) ①	—	—	72		
V_{SD}	Diode Forward Voltage	—	—	2.0	V	$T_J=25^\circ\text{C}$, $I_S=18\text{A}$, $V_{GS}=0\text{V}$ ④
t_{rr}	Reverse Recovery Time	—	300	610	ns	$T_J=25^\circ\text{C}$, $I_F=18\text{A}$
Q_{rr}	Reverse Recovery Charge	—	3.4	7.1	μC	$di/dt=100\text{A}/\mu\text{s}$ ④
t_{on}	Forward Turn-On Time	Intrinsic turn-on time is negligible (turn-on is dominated by L_S+L_D)				

Notes:

- ① Repetitive rating; pulse width limited by max. junction temperature (See Figure 11)
- ② $V_{DD}=50\text{V}$, starting $T_J=25^\circ\text{C}$, $L=2.7\text{mH}$, $R_G=25\Omega$, $I_{AS}=18\text{A}$ (See Figure 12)
- ③ $I_{SD}\leq 18\text{A}$, $di/dt\leq 150\text{A}/\mu\text{s}$, $V_{DD}\leq V_{(BR)DSS}$, $T_J\leq 150^\circ\text{C}$
- ④ Pulse width $\leq 300\mu\text{s}$; duty cycle $\leq 2\%$.

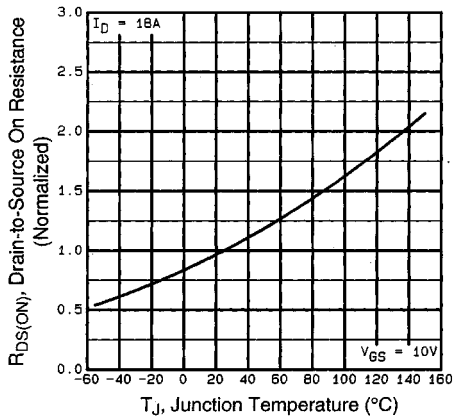
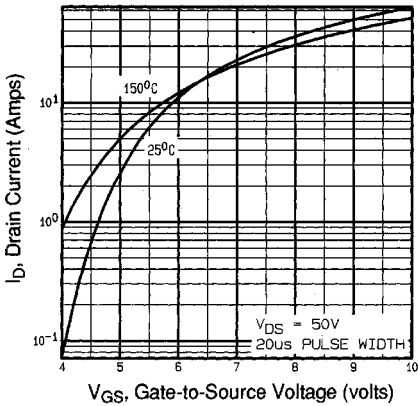
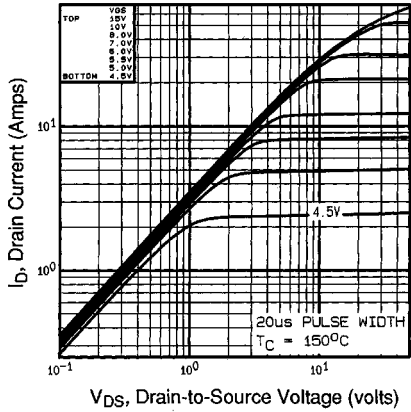
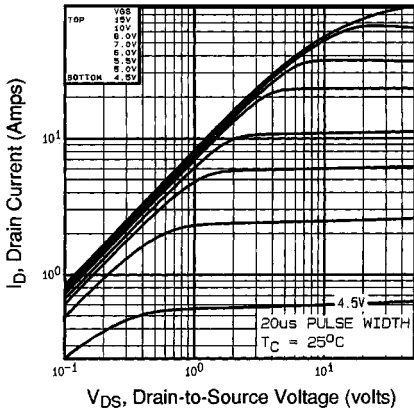

DATA SHEETS

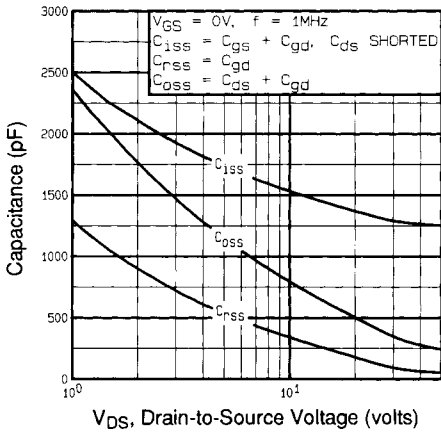

Fig 5. Typical Capacitance Vs. Drain-to-Source Voltage

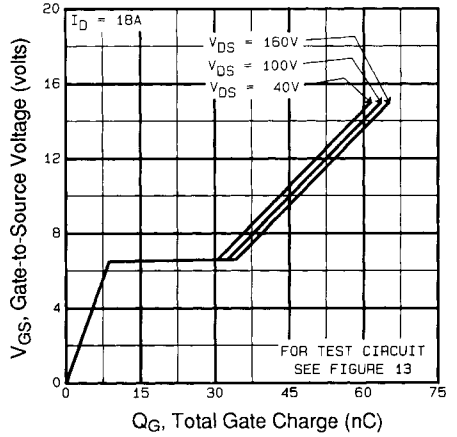

Fig 6. Typical Gate Charge Vs. Gate-to-Source Voltage

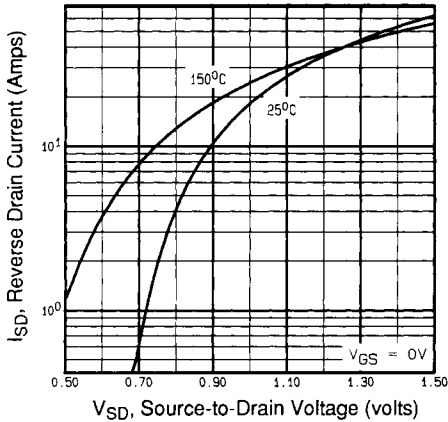

Fig 7. Typical Source-Drain Diode Forward Voltage

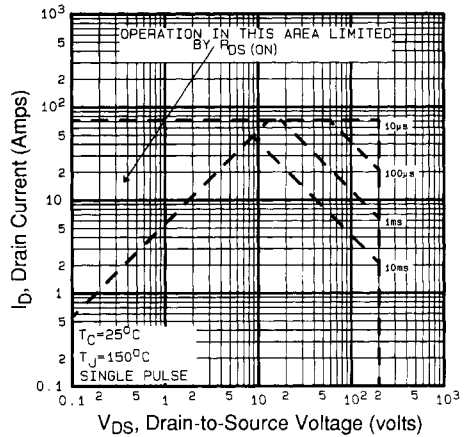

Fig 8. Maximum Safe Operating Area

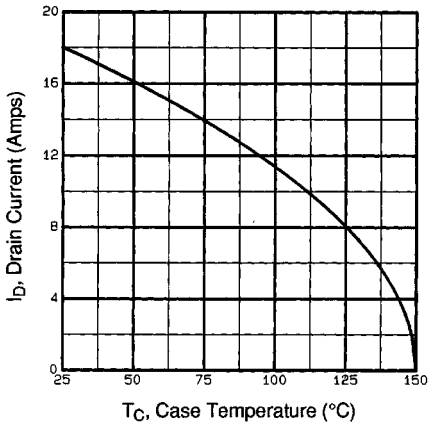

Fig 9. Maximum Drain Current Vs. Case Temperature

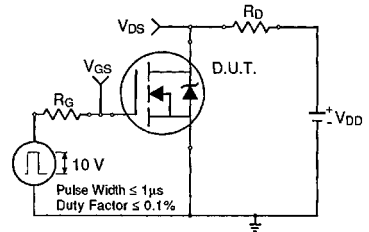

Fig 10a. Switching Time Test Circuit

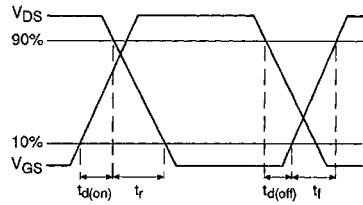

Fig 10b. Switching Time Waveforms

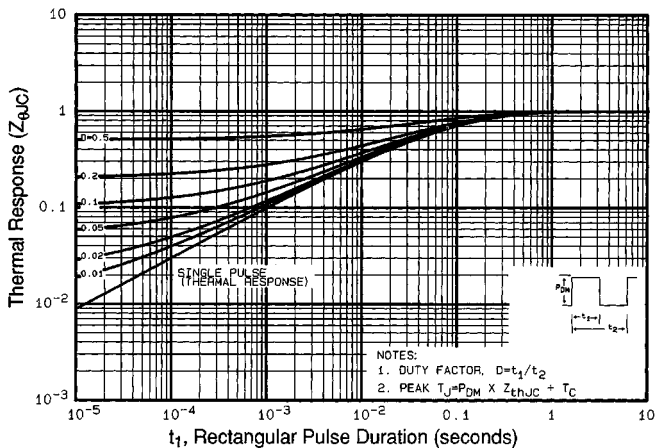

Fig 11. Maximum Effective Transient Thermal Impedance, Junction-to-Case

DATA SHEETS

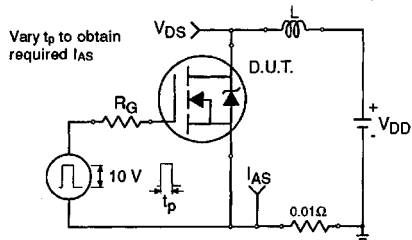

Fig 12a. Unclamped Inductive Test Circuit

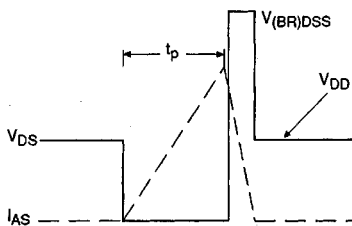

Fig 12b. Unclamped Inductive Waveforms

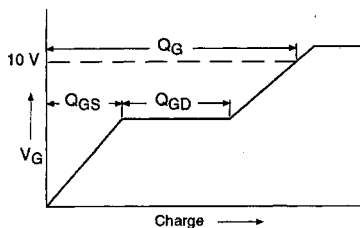

Fig 13a. Basic Gate Charge Waveform

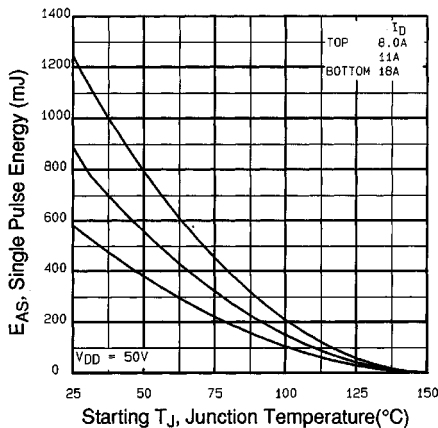

Fig 12c. Maximum Avalanche Energy Vs. Drain Current

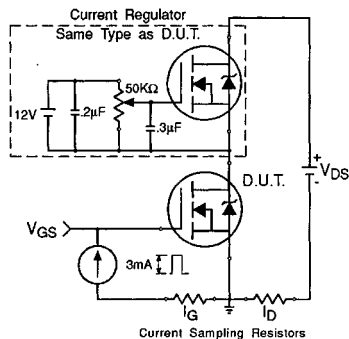

Fig 13b. Gate Charge Test Circuit

Appendix A: Figure 14, Peak Diode Recovery dv/dt Test Circuit – See page 1505

Appendix B: Package Outline Mechanical Drawing – See page 1509

Appendix C: Part Marking Information – See page 1516

Appendix E: Optional Leadforms – See page 1525