

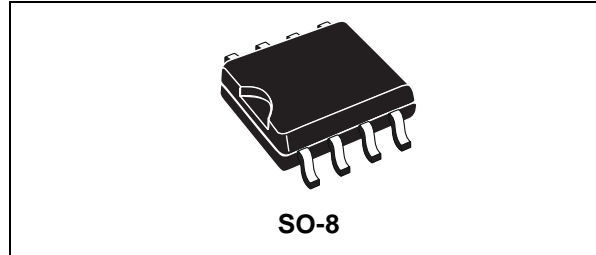

# STS3DPFS30L

## P-CHANNEL 30V - 0.13Ω - 3A SO-8 STripFET™ MOSFET PLUS SCHOTTKY RECTIFIER

MAIN PRODUCT CHARACTERISTICS			
<b>MOSFET</b>	<b>V<sub>DSS</sub></b>	<b>R<sub>DS(on)</sub></b>	<b>I<sub>D</sub></b>
	30 V	< 0.165 Ω	3 A
<b>SCHOTTKY</b>	<b>I<sub>F(AV)</sub></b>	<b>V<sub>RRM</sub></b>	<b>V<sub>F(MAX)</sub></b>
	3 A	30 V	0.51 V



### DESCRIPTION

This product associates the latest low voltage STripFET™ in p-channel version to a low drop Schottky diode. Such configuration is extremely versatile in implementing, a large variety of DC-DC converters for printers, portable equipment, and cellular phones.

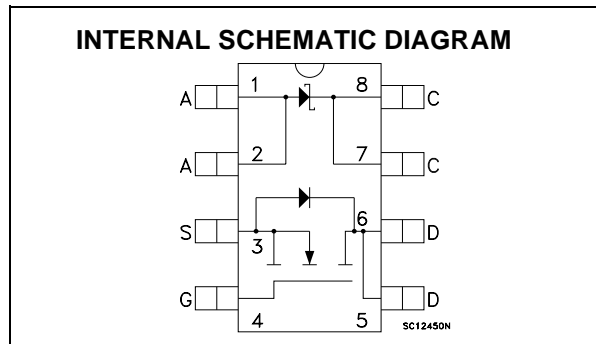

### MOSFET ABSOLUTE MAXIMUM RATINGS

Symbol	Parameter	Value	Unit
V <sub>DS</sub>	Drain-source Voltage (V <sub>GS</sub> = 0)	30	V
V <sub>DGR</sub>	Drain-gate Voltage (R <sub>GS</sub> = 20 kΩ)	30	V
V <sub>GS</sub>	Gate- source Voltage	± 15	V
I <sub>D</sub>	Drain Current (continuous) at T <sub>C</sub> = 25°C	3	A
I <sub>D</sub>	Drain Current (continuous) at T <sub>C</sub> = 100°C	1.9	A
I <sub>DM</sub> (●)	Drain Current (pulsed)	12	A
P <sub>TOT</sub>	Total Dissipation at T <sub>C</sub> = 25°C	2	W

### SCHOTTKY ABSOLUTE MAXIMUM RATINGS

Symbol	Parameter		Value	Unit
V <sub>RRM</sub>	Repetitive Peak Reverse Voltage		30	V
I <sub>F(RMS)</sub>	RMS Forward Current		20	A
I <sub>F(AV)</sub>	Average Forward Current	TL = 125°C δ = 0.5	3	A
I <sub>FSM</sub>	Surge Non Repetitive Forward Current	t <sub>p</sub> = 10 ms Sinusoidal	75	A
I <sub>RSM</sub>	Non Repetitive Peak Reverse Current	t <sub>p</sub> = 100 μs	1	A
dv/dt	Critical Rate Of Rise Of Reverse Voltage		10000	V/μs

(\*) Pulse width limited by safe operating area  
 (1) I<sub>SD</sub> ≤ 3A, di/dt ≤ 300A/μs, V<sub>DD</sub> ≤ V<sub>(BR)DSS</sub>, T<sub>j</sub> ≤ T<sub>JMAX</sub>.  
 February 2001

Note: For the P-CHANNEL MOSFET actual polarity of Voltages and current has to be reversed

## STS3DPFS30L

### THERMAL DATA

Rthj-amb	(*)Thermal Resistance Junction-ambient MOSFET	62.5	°C/W
Rthj-amb	(*)Thermal Resistance Junction-ambient SCHOTTKY Maximum	100	°C/W
T <sub>stg</sub>	Storage Temperature Range	-65 to 150	°C
T <sub>J</sub>	Junction Temperature (* ) Mounted on FR-4 board (Steady State)	150	°C

### MOSFET ELECTRICAL CHARACTERISTICS (TCASE = 25 °C UNLESS OTHERWISE SPECIFIED) OFF

Symbol	Parameter	Test Conditions	Min.	Typ.	Max.	Unit
V <sub>(BR)DSS</sub>	Drain-source Breakdown Voltage	I <sub>D</sub> = 250 μA, V <sub>GS</sub> = 0	30			V
I <sub>DSS</sub>	Zero Gate Voltage Drain Current (V <sub>GS</sub> = 0)	V <sub>DS</sub> = Max Rating V <sub>DS</sub> = Max Rating, T <sub>C</sub> = 125 °C			1 10	μA μA
I <sub>GSS</sub>	Gate-body Leakage Current (V <sub>DS</sub> = 0)	V <sub>GS</sub> = ± 15 V			±100	nA

### ON (1)

Symbol	Parameter	Test Conditions	Min.	Typ.	Max.	Unit
V <sub>GS(th)</sub>	Gate Threshold Voltage	V <sub>DS</sub> = V <sub>GS</sub> , I <sub>D</sub> = 250μA	1		2.5	V
R <sub>DS(on)</sub>	Static Drain-source On Resistance	V <sub>GS</sub> = 10V, I <sub>D</sub> = 1.5 A V <sub>GS</sub> = 4.5V, I <sub>D</sub> = 1.5 A		0.13 0.15	0.165 0.20	Ω Ω
I <sub>D(on)</sub>	On State Drain Current	V <sub>DS</sub> > I <sub>D(on)</sub> × R <sub>DS(on)max</sub> , V <sub>GS</sub> = 10V	3			A

### DYNAMIC

Symbol	Parameter	Test Conditions	Min.	Typ.	Max.	Unit
g <sub>fs</sub> (1)	Forward Transconductance	V <sub>DS</sub> > I <sub>D(on)</sub> × R <sub>DS(on)max</sub> , I <sub>D</sub> = 1.5 A		3.5		S
C <sub>iss</sub>	Input Capacitance	V <sub>DS</sub> = 25V, f = 1 MHz, V <sub>GS</sub> = 0		510		pF
C <sub>oss</sub>	Output Capacitance			170		pF
C <sub>rss</sub>	Reverse Transfer Capacitance			55		pF

**ELECTRICAL CHARACTERISTICS (CONTINUED)**

**SWITCHING ON**

Symbol	Parameter	Test Conditions	Min.	Typ.	Max.	Unit
$t_{d(on)}$	Turn-on Delay Time	$V_{DD} = 15\text{ V}$ , $I_D = 1.5\text{ A}$ $R_G = 4.7\ \Omega$ , $V_{GS} = 4.5\text{ V}$ (see test circuit, Figure 3)		15		ns
$t_r$	Rise Time			37		ns
$Q_g$	Total Gate Charge	$V_{DD} = 15\text{ V}$ , $I_D = 3\text{ A}$ , $V_{GS} = 4.5\text{ V}$		5.5	7.5	nC
$Q_{gs}$	Gate-Source Charge			1.7		nC
$Q_{gd}$	Gate-Drain Charge			1.8		nC

**SWITCHING OFF**

Symbol	Parameter	Test Conditions	Min.	Typ.	Max.	Unit
$t_{d(off)}$	Turn-off Delay Time	$V_{DD} = 15\text{ V}$ , $I_D = 1.5\text{ A}$ , $R_G = 4.7\ \Omega$ , $V_{GS} = 4.5\text{ V}$ (see test circuit, Figure 3)		88		ns
$t_f$	Fall Time			23		ns

**SOURCE DRAIN DIODE**

Symbol	Parameter	Test Conditions	Min.	Typ.	Max.	Unit
$I_{SD}$	Source-drain Current				3	A
$I_{SDM(2)}$	Source-drain Current (pulsed)				12	A
$V_{SD(1)}$	Forward On Voltage	$I_{SD} = 3\text{ A}$ , $V_{GS} = 0$			1.2	V
$t_{rr}$	Reverse Recovery Time	$I_{SD} = 3\text{ A}$ , $di/dt = 100\text{ A}/\mu\text{s}$ , $V_{DD} = 20\text{ V}$ , $T_j = 25^\circ\text{C}$ (see test circuit, Figure 5)		16		ns
$Q_{rr}$	Reverse Recovery Charge			10		nC
$I_{RRM}$	Reverse Recovery Current			1.15		A

Note: 1. Pulsed: Pulse duration = 300  $\mu\text{s}$ , duty cycle 1.5 %.  
2. Pulse width limited by safe operating area.

**SCHOTTKY STATIC ELECTRICAL CHARACTERISTICS**

Symbol	Parameter	Test Conditions	Min.	Typ.	Max.	Unit
$I_R(^*)$	Reversed Leakage Current	$T_J = 25^\circ\text{C}$ , $V_R = 30\text{ V}$ $T_J = 125^\circ\text{C}$ , $V_R = 30\text{ V}$		0.03	0.2 100	mA mA
$V_F(^*)$	Forward Voltage Drop	$T_J = 25^\circ\text{C}$ , $I_F = 3\text{ A}$ $T_J = 125^\circ\text{C}$ , $I_F = 3\text{ A}$		0.46	0.51 0.46	V V

Safe Operating Area

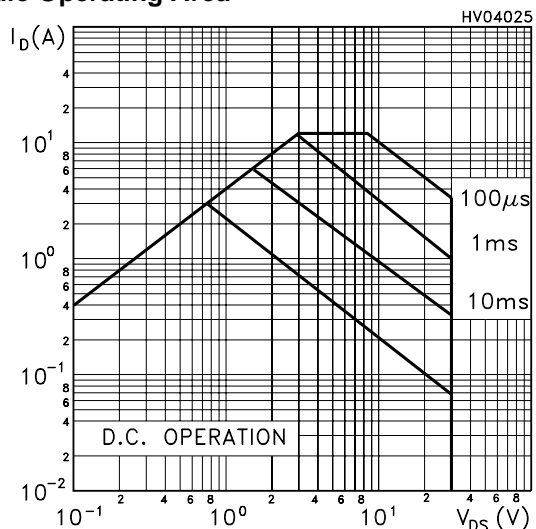

Thermal Impedance

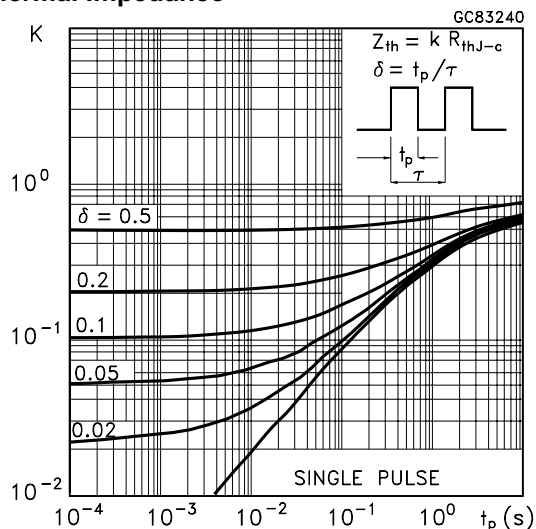

Output Characteristics

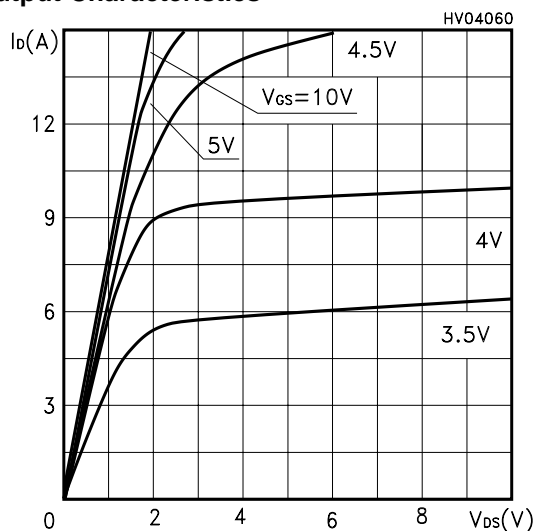

Transfer Characteristics

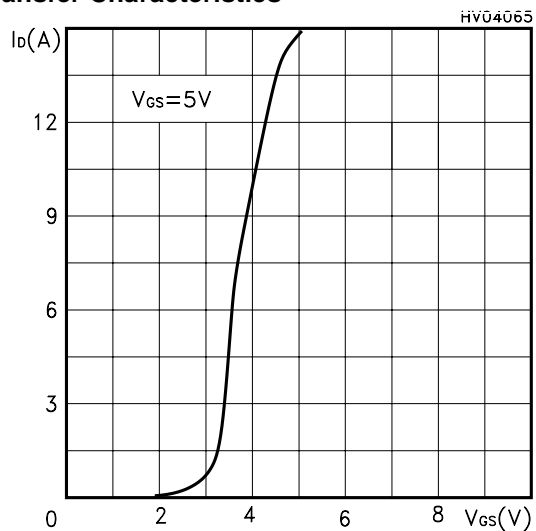

Transconductance

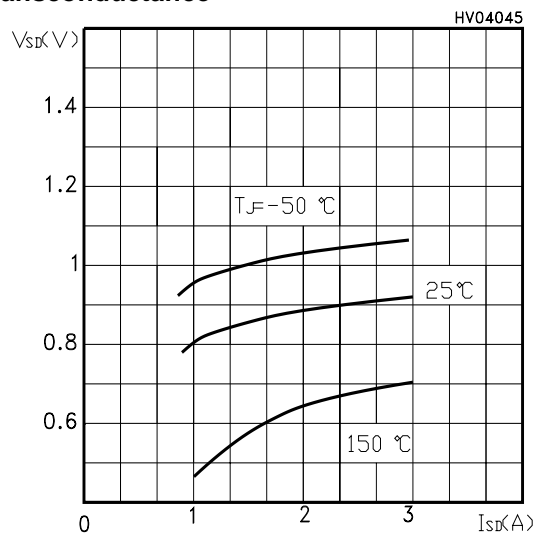

Static Drain-source On Resistance

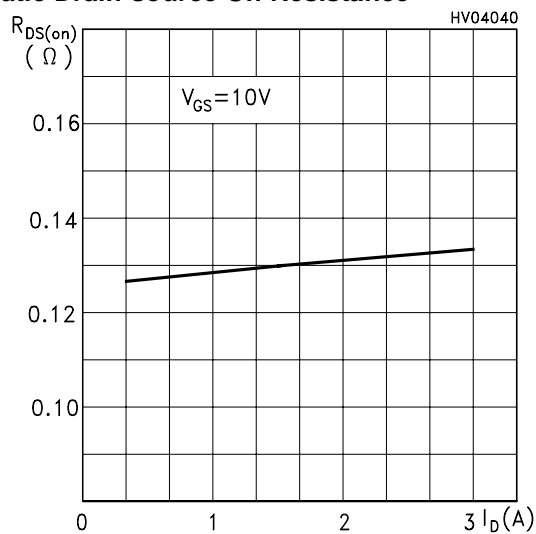

**Gate Charge vs Gate-source Voltage**

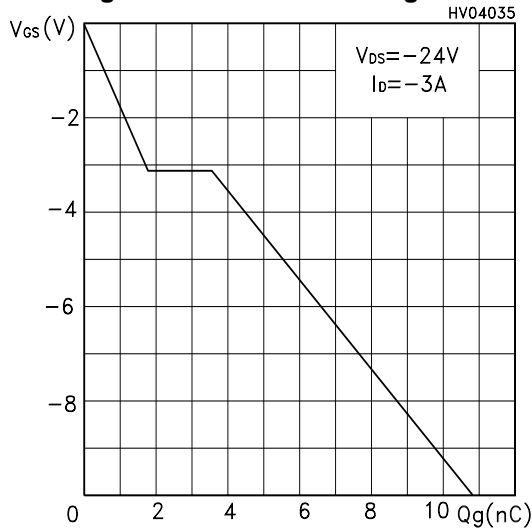

**Capacitance Variations**

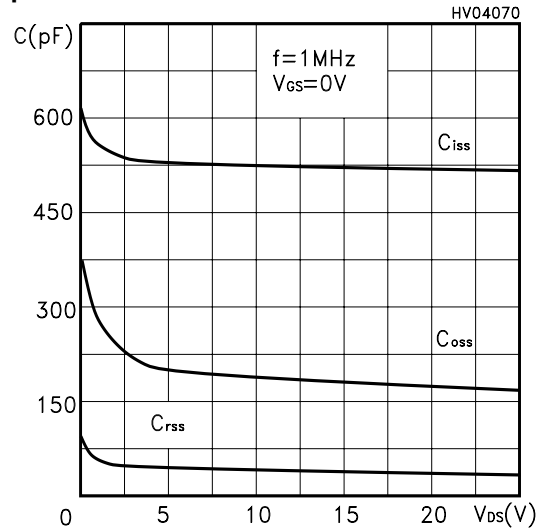

**Normalized Gate Threshold Voltage vs Temp.**

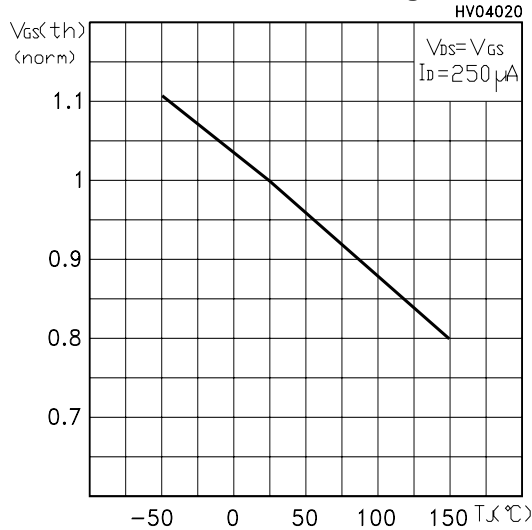

**Normalized On Resistance vs Temperature**

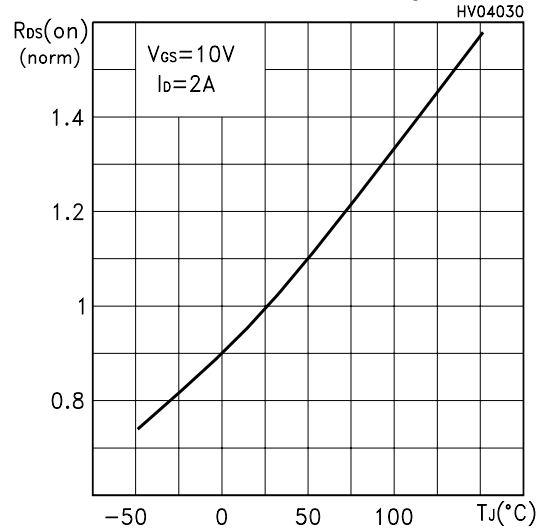

**Source-drain Diode Forward Characteristics**

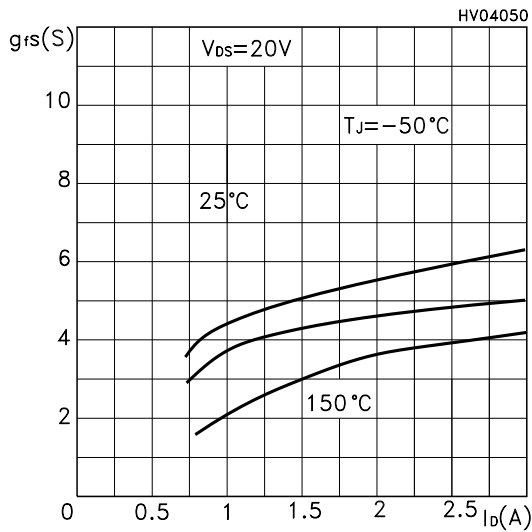

Fig. 1: Unclamped Inductive Load Test Circuit



Fig. 2: Unclamped Inductive Waveform



Fig. 3: Switching Times Test Circuits For Resistive Load



Fig. 4: Gate Charge test Circuit

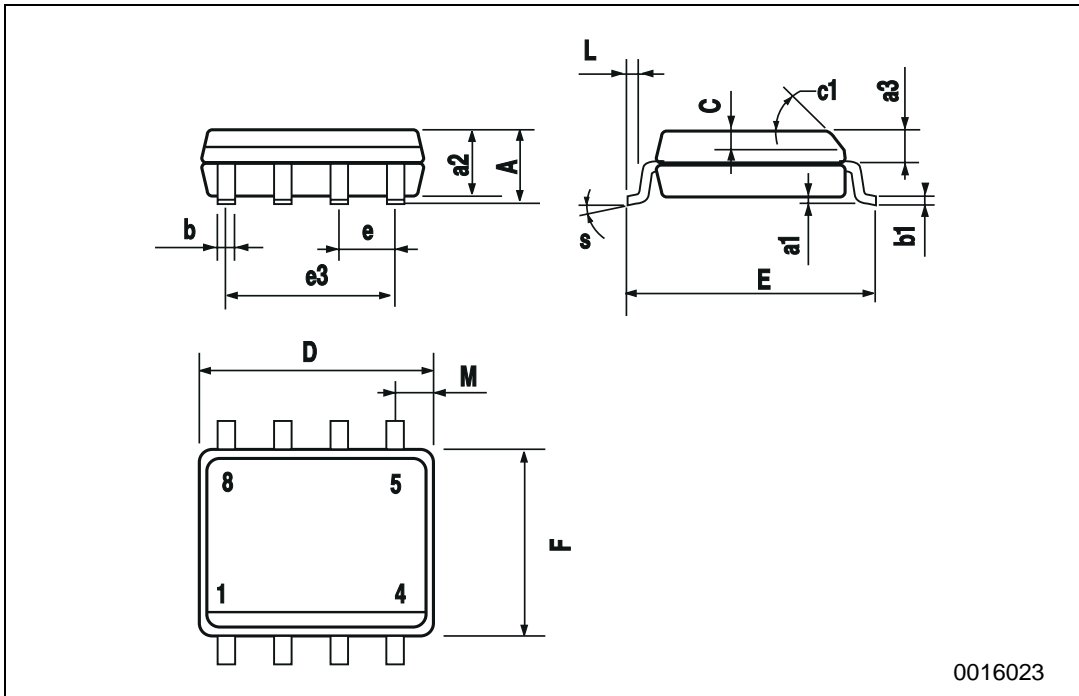

Fig. 5: Test Circuit For Inductive Load Switching And Diode Recovery Times



**SO-8 MECHANICAL DATA**

DIM.	mm			inch		
	MIN.	TYP.	MAX.	MIN.	TYP.	MAX.
A			1.75			0.068
a1	0.1		0.25	0.003		0.009
a2			1.65			0.064
a3	0.65		0.85	0.025		0.033
b	0.35		0.48	0.013		0.018
b1	0.19		0.25	0.007		0.010
C	0.25		0.5	0.010		0.019
c1	45 (typ.)					
D	4.8		5.0	0.188		0.196
E	5.8		6.2	0.228		0.244
e		1.27			0.050	
e3		3.81			0.150	
F	3.8		4.0	0.14		0.157
L	0.4		1.27	0.015		0.050
M			0.6			0.023
S	8 (max.)					



Information furnished is believed to be accurate and reliable. However, STMicroelectronics assumes no responsibility for the consequences of use of such information nor for any infringement of patents or other rights of third parties which may result from its use. No license is granted by implication or otherwise under any patent or patent rights of STMicroelectronics. Specification mentioned in this publication are subject to change without notice. This publication supersedes and replaces all information previously supplied. STMicroelectronics products are not authorized for use as critical components in life support devices or systems without express written approval of STMicroelectronics.

The ST logo is a trademark of STMicroelectronics

© 2000 STMicroelectronics – Printed in Italy – All Rights Reserved  
STMicroelectronics GROUP OF COMPANIES

Australia - Brazil - China - Finland - France - Germany - Hong Kong - India - Italy - Japan - Malaysia - Malta - Morocco -  
Singapore - Spain - Sweden - Switzerland - United Kingdom - U.S.A.

<http://www.st.com>