



10MHz to 500MHz VCO Buffer Amplifiers with Differential Outputs

General Description

The MAX2470/MAX2471 are flexible, low-cost, high-reverse-isolation buffer amplifiers for applications with discrete and module-based VCO designs. Both feature differential 50Ω outputs for driving a single differential (balanced) load or two separate single-ended (unbalanced) 50Ω loads. The MAX2470 offers a single-ended input and has two selectable frequency ranges of operation: 10MHz to 500MHz and 10MHz to 200MHz. The MAX2471 offers a differential input and operates from 10MHz to 500MHz. The MAX2470/MAX2471 also feature high input impedance for maximum flexibility, enabling them to be used with a variety of oscillator topologies. High reverse isolation combined with low supply current make them ideal for applications requiring high performance with low power.

These devices are also ideal for use as active baluns. The MAX2470 converts a single-ended input to a differential output. The MAX2471 is useful as a differential buffer stage or to convert from a differential input to two single-ended outputs.

The MAX2470 operates from a single +2.7V to +5.5V supply. At -5dBm output power, it consumes 5.5mA in the high-frequency range and only 3.6mA in the low-frequency range. The MAX2471 operates from a +2.7V to +5.5V single supply and consumes 5.5mA. Both devices are available in ultra-small SOT23-6 plastic packages, requiring minimal board space.

Applications

Cellular and PCS Mobile Phones
ISM-Band Applications
Active Baluns
General-Purpose Buffers/Amplifiers

Pin Configuration

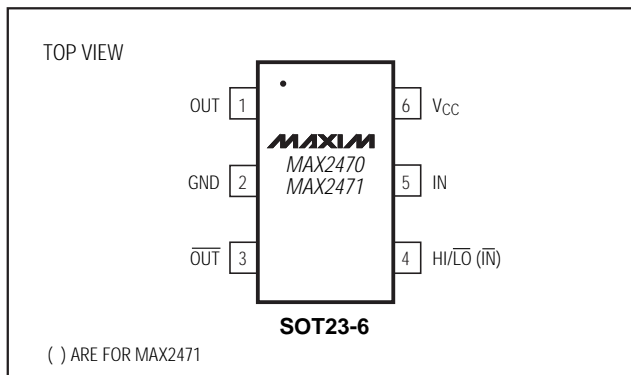

Features

- ◆ +2.7V to +5.5V Supply Range
- ◆ Input Frequency Range
 - High: 10MHz to 500MHz (MAX2470/2471)
 - Low: 10MHz to 200MHz (MAX2470)
- ◆ >14dB Power Gain at 200MHz
- ◆ 64dB Typical Reverse Isolation at 200MHz
- ◆ Low-Distortion Output Drive
- ◆ Ultra-Small SOT23-6 Package
- ◆ High Input Impedance
- ◆ Single-Ended (MAX2470) or Differential (MAX2471) Inputs

Ordering Information

| PART | TEMP. RANGE | PIN-PACKAGE | SOT TOP MARK |
|--------------|----------------|-------------|--------------|
| MAX2470EUT-T | -40°C to +85°C | 6 SOT23-6 | AAAX |
| MAX2471EUT-T | -40°C to +85°C | 6 SOT23-6 | AAAY |

Typical Operating Circuits

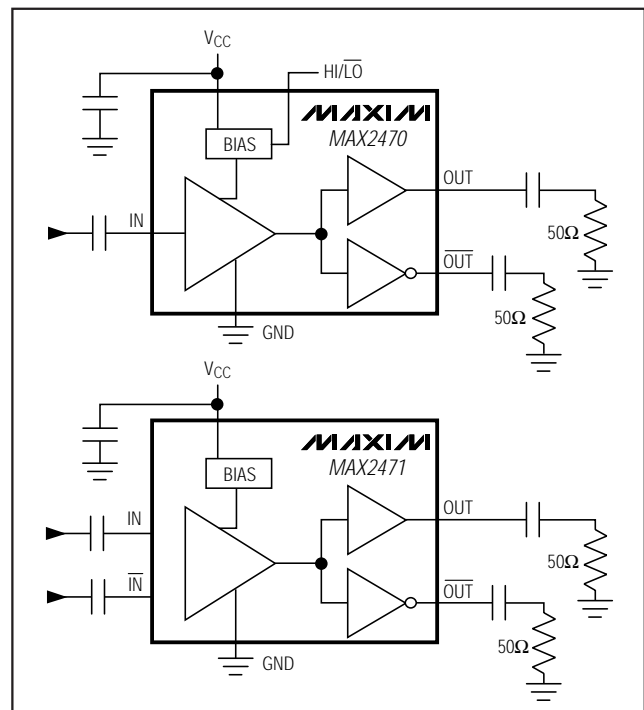

10MHz to 500MHz VCO Buffer Amplifiers with Differential Outputs

ABSOLUTE MAXIMUM RATINGS

V_{CC} to GND-0.3V to +7V
 IN to GND.....-0.3V to (V_{CC} + 0.3V) or 3.7V (whichever is lower)
 $\overline{\text{IN}}$ to IN-2.2V to +2.2V
 HI/ $\overline{\text{LO}}$ to GND-0.3V to (V_{CC} + 0.3V)
 Continuous Power Dissipation
 SOT23-6 (derate 8.7mW/°C above +70°C).....696mW

Operating Temperature Range-40°C to +85°C
 Junction Temperature+150°C
 Storage Temperature Range-65°C to +150°C
 Lead Temperature (soldering, 10sec)+300°C

Stresses beyond those listed under "Absolute Maximum Ratings" may cause permanent damage to the device. These are stress ratings only, and functional operation of the device at these or any other conditions beyond those indicated in the operational sections of the specifications is not implied. Exposure to absolute maximum rating conditions for extended periods may affect device reliability.

DC ELECTRICAL CHARACTERISTICS

(Typical Operating Circuit, V_{CC} = +2.7V to +5.5V, T_A = T_{MIN} to T_{MAX}, unless otherwise noted. Typical values are at V_{CC} = +3V, T_A = +25°C.) (Note 1)

| PARAMETER | SYMBOL | CONDITIONS | | MIN | TYP | MAX | UNITS |
|---|-----------------|--|---|-----|-----|-----|-------|
| Supply Voltage Range | V _{CC} | | | 2.7 | | 5.5 | V |
| Supply Current | I _{CC} | HI/ $\overline{\text{LO}}$ = V _{CC} | No signal | | 5.1 | 7.4 | mA |
| | | | P _{OUT} = -5dBm, R _{LOAD} = 100Ω diff. | | 5.5 | | |
| | | HI/ $\overline{\text{LO}}$ = GND | No signal | | 3.0 | 4.5 | |
| | | | P _{OUT} = -5dBm, R _{LOAD} = 100Ω diff. | | 3.6 | | |
| HI/ $\overline{\text{LO}}$ Input Level High | V _{IH} | | | 2.0 | | | V |
| HI/ $\overline{\text{LO}}$ Input Level Low | V _{IL} | | | | | 0.6 | V |
| HI/ $\overline{\text{LO}}$ Input Bias Current | I _{IN} | V _{HI/$\overline{\text{LO}}$} = GND or V _{CC} | | -10 | | 10 | μA |

AC ELECTRICAL CHARACTERISTICS—MAX2470

(V_{CC} = +3V, HI/ $\overline{\text{LO}}$ = V_{CC}, all outputs are differentially measured between OUT and $\overline{\text{OUT}}$ driving a 50Ω load through a 180° hybrid, T_A = +25°C, unless otherwise noted.)

| PARAMETER | SYMBOL | CONDITIONS | | MIN | TYP | MAX | UNITS |
|-----------------------------------|--------------------------------|---|---|-----|------|------|-------|
| Input Frequency Range (Note 2) | f _{IN} | HI/ $\overline{\text{LO}}$ = V _{CC} | | 10 | | 500 | MHz |
| | | HI/ $\overline{\text{LO}}$ = GND | | 10 | | 200 | |
| Gain (Note 3) | S ₂₁ ² | HI/ $\overline{\text{LO}}$ = V _{CC} | f _{IN} = 10MHz | | 14.9 | | dB |
| | | | f _{IN} = 200MHz | | 14.9 | | |
| | | | f _{IN} = 500MHz, T _A = T _{MIN} to T _{MAX} | 8.9 | 13.3 | 15.3 | |
| | | HI/ $\overline{\text{LO}}$ = GND | f _{IN} = 10MHz | | 13.8 | | |
| | | | f _{IN} = 200MHz | | 14.1 | | |
| | | | f _{IN} = 200MHz, T _A = T _{MIN} to T _{MAX} | 9.9 | 13.4 | 15.0 | |
| Voltage Gain (Note 4) | A _V | f _{IN} = 10MHz, HI/ $\overline{\text{LO}}$ = GND | | | 16 | | V/V |
| Noise Figure | NF | R _{SOURCE} = 50Ω | f _{OUT} = 500MHz, HI/ $\overline{\text{LO}}$ = V _{CC} | | 10.2 | | dB |
| | | | f _{OUT} = 200MHz, R _{HI/$\overline{\text{LO}}$} = GND | | 10.2 | | |

10MHz to 500MHz VCO Buffer Amplifiers with Differential Outputs

MAX2470/MAX2471

AC ELECTRICAL CHARACTERISTICS—MAX2470 (continued)

($V_{CC} = +3V$, $HI/\overline{LO} = V_{CC}$, all outputs are differentially measured between OUT and \overline{OUT} driving a 50Ω load through a 180° hybrid, $T_A = +25^\circ C$, unless otherwise noted.)

| PARAMETER | SYMBOL | CONDITIONS | MIN | TYP | MAX | UNITS |
|--|---------------------------------|---|-------------------|-----|-----|-------|
| Maximum Output VSWR (OUT , \overline{OUT}) (Note 5) | VSWR _{OUT} | 10MHz < f_{OUT} < 500MHz, $HI/\overline{LO} = V_{CC}$ | 1.5:1 | | | |
| | | 10MHz < f_{OUT} < 200MHz, $HI/\overline{LO} = GND$ | 1.2:1 | | | |
| Reverse Isolation (Note 6) | IS ₁₂ I ² | $HI/\overline{LO} = V_{CC}$ | $f_{IN} = 100MHz$ | 75 | | dB |
| | | | $f_{IN} = 500MHz$ | 48 | | |
| | | $HI/\overline{LO} = GND$ | $f_{IN} = 100MHz$ | 75 | | |
| | | | $f_{IN} = 200MHz$ | 64 | | |
| Isolation OUT to \overline{OUT} (Note 7) | | $f_{IN} = 500MHz$, $HI/\overline{LO} = V_{CC}$ | 37 | | dB | |
| | | $f_{IN} = 200MHz$, $HI/\overline{LO} = GND$ | 45 | | | |
| Harmonic Suppression | | $f_{IN} = 500MHz$, $P_{OUT} = -5dBm$, $HI/\overline{LO} = V_{CC}$ | -26 | | dBc | |
| | | $f_{IN} = 200MHz$, $P_{OUT} = -5dBm$, $HI/\overline{LO} = GND$ | -30 | | | |

AC ELECTRICAL CHARACTERISTICS—MAX2471

(Typical values are measured at $V_{CC} = +3V$, $T_A = +25^\circ C$, unless otherwise noted.) (Note 8)

| PARAMETER | SYMBOL | CONDITIONS | MIN | TYP | MAX | UNITS |
|--|---------------------------------|--|-------|------|-----|-------|
| Input Frequency Range (Note 2) | f_{IN} | | 10 | | 500 | MHz |
| Gain (Note 3) | IS ₂₁ I ² | $f_{IN} = 10MHz$ | 15.9 | | dB | |
| | | $f_{IN} = 200MHz$ | 16.9 | | | |
| | | $f_{IN} = 500MHz$, $T_A = T_{MIN}$ to T_{MAX} | 11.3 | 15.6 | | 17.8 |
| Voltage Gain (Note 4) | A_V | $f_{IN} = 10MHz$ | 16 | | V/V | |
| Noise Figure | NF | $f_{OUT} = 500MHz$, $R_{SOURCE} = 50\Omega$ | 8.4 | | dB | |
| Maximum Output VSWR (OUT , \overline{OUT}) (Note 5) | VSWR _{OUT} | 10MHz < f_{OUT} < 500MHz | 1.5:1 | | | |
| Reverse Isolation | IS ₁₂ I ² | $f_{IN} = 100MHz$ | 74 | | dB | |
| | | $f_{IN} = 500MHz$ | 57 | | | |
| Isolation OUT to \overline{OUT} (Note 7) | | $f_{IN} = 500MHz$ | 35 | | dB | |
| Harmonic Suppression | | $f_{IN} = 500MHz$, $P_{OUT} = -5dBm$ | -29 | | dBc | |

Note 1: Limits are 100% production tested at $T_A = +25^\circ C$. Limits over the entire operating temperature range are guaranteed by design and characterization but are not production tested.

Note 2: The part has been characterized over the specified frequency range. Operation outside of this range is possible but not guaranteed.

Note 3: Gain specified for $P_{OUT} = -5dBm$.

Note 4: Voltage gain measured with no input termination and no output load.

Note 5: Output VSWR is a single-ended measurement for each OUT and \overline{OUT} .

Note 6: OUT to IN isolation with \overline{OUT} terminated with 50Ω .

Note 7: Input terminated with 50Ω .

Note 8: Unless otherwise noted: all inputs are differentially measured between IN and \overline{IN} driven by a 50Ω load through a 180° hybrid; all outputs are differentially measured between OUT and \overline{OUT} driving a 50Ω load through a 180° hybrid.

10MHz to 500MHz VCO Buffer Amplifiers with Differential Outputs

Typical Operating Characteristics

($V_{CC} = +3.0V$, MAX2470 output and MAX2471 input and output measurements taken differentially, $T_A = +25^\circ C$, unless otherwise noted.)

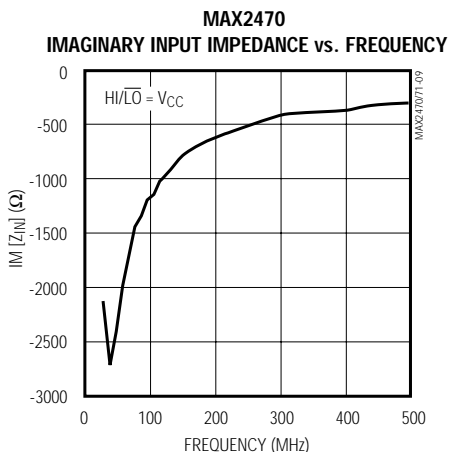
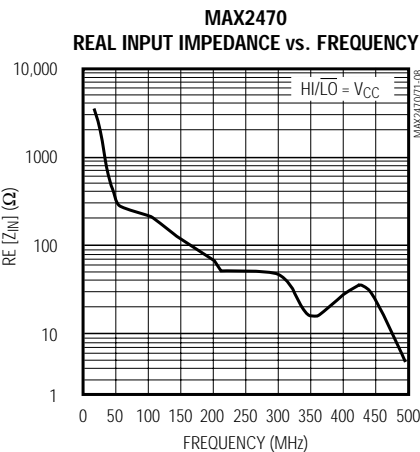
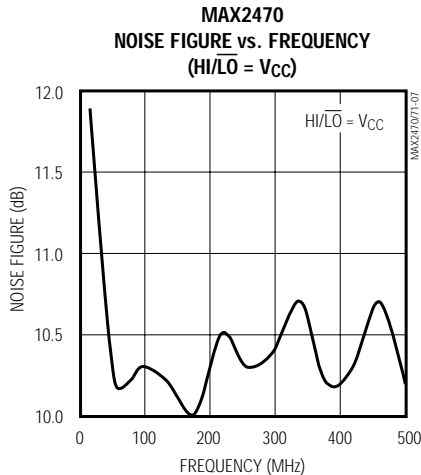
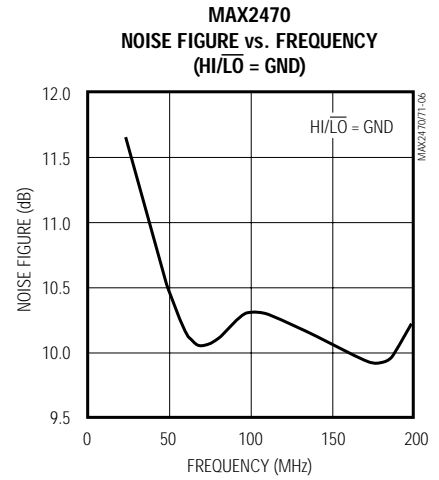
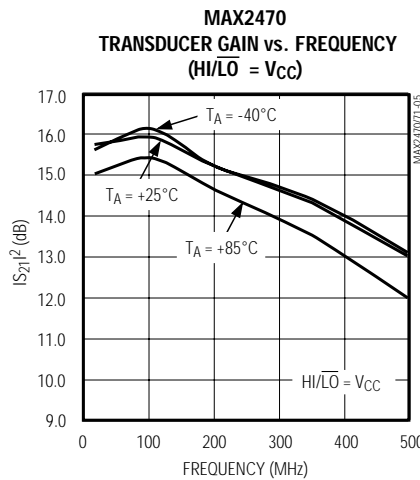
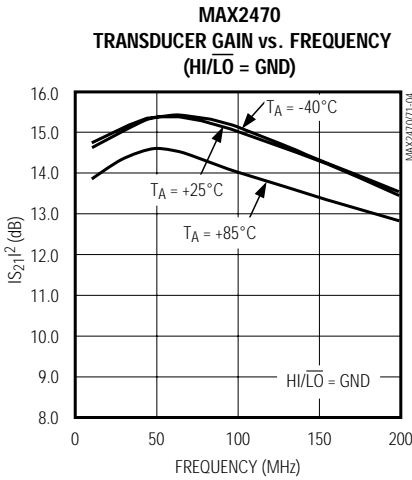
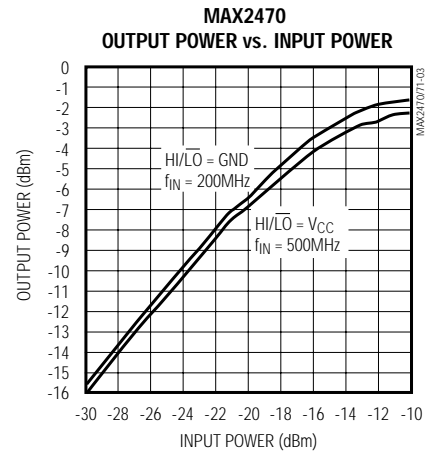
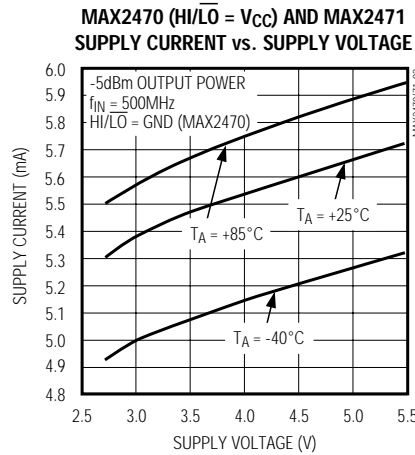
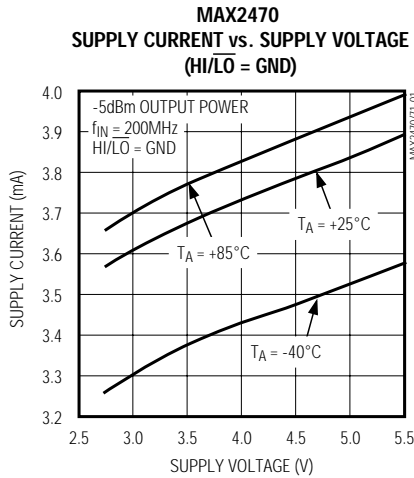

10MHz to 500MHz VCO Buffer Amplifiers with Differential Outputs

MAX2470/MAX2471

Typical Operating Characteristics (continued)

($V_{CC} = +3.0V$, MAX2470 output and MAX2471 input and output measurements taken differentially, $T_A = +25^\circ C$ unless otherwise noted.)

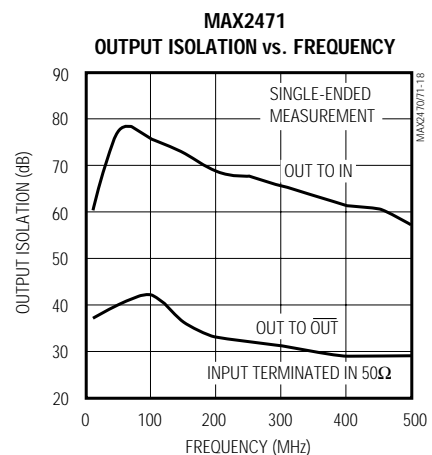
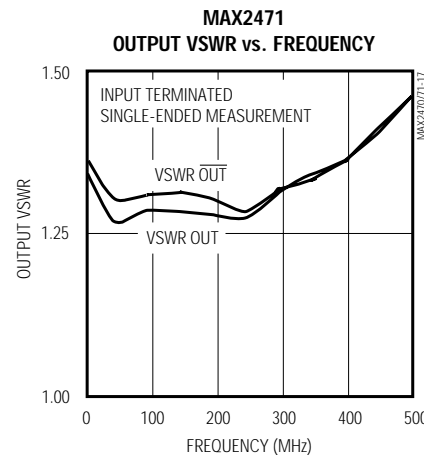
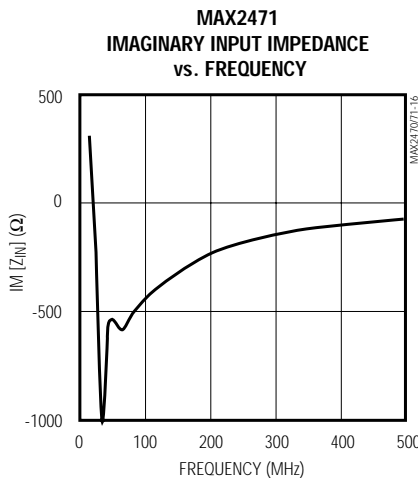
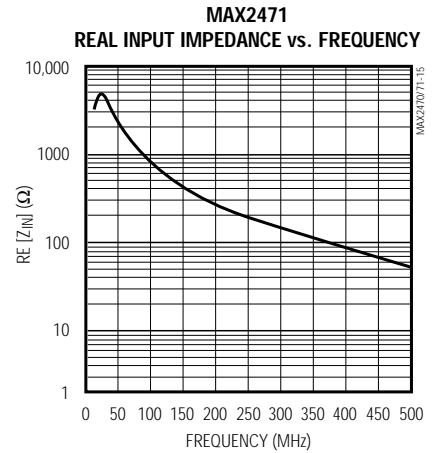
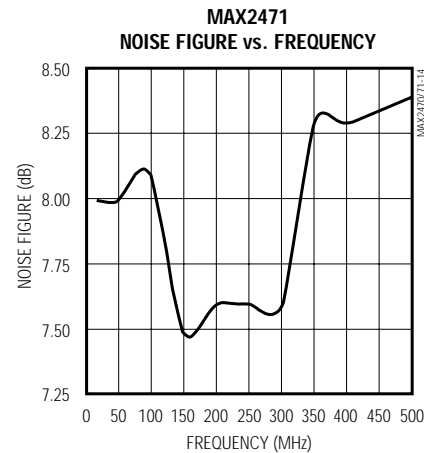
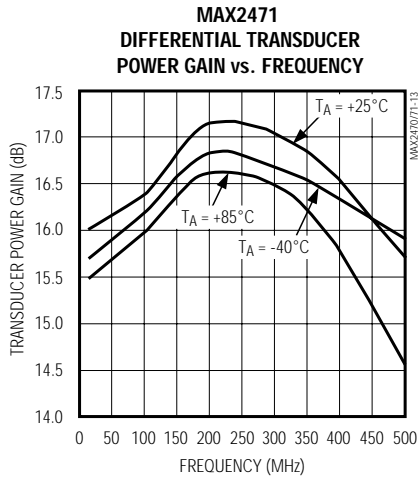
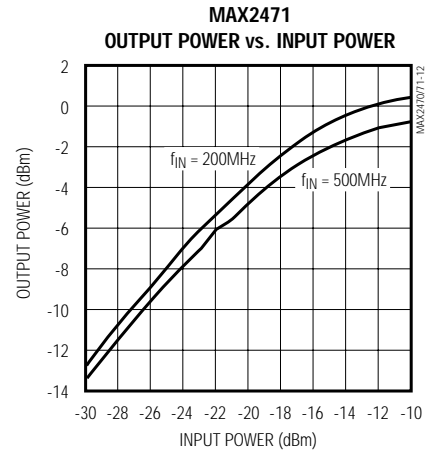
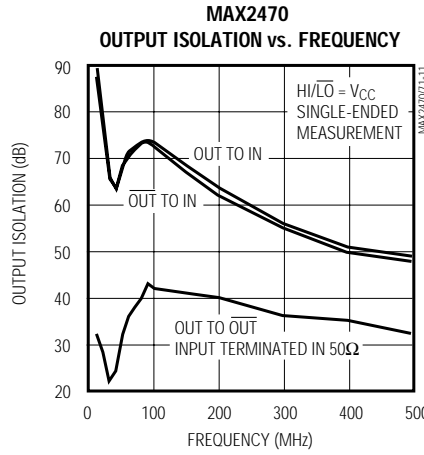
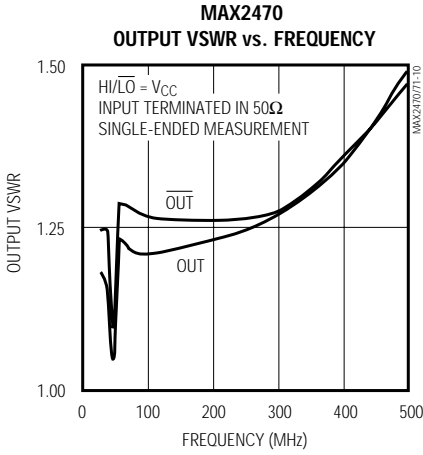

10MHz to 500MHz VCO Buffer Amplifiers with Differential Outputs

Pin Description

| PIN | | NAME | FUNCTION |
|---------|---------|----------------------------|--|
| MAX2470 | MAX2471 | | |
| 1 | 1 | OUT | Differential Noninverting Buffer Output. Broadband 50Ω output. AC coupling is required. Do not DC couple to this pin. |
| 2 | 2 | GND | RF Ground. Connect to the ground plane as close as possible to the IC to minimize ground path inductance. |
| 3 | 3 | $\overline{\text{OUT}}$ | Differential Inverting Buffer Output. Broadband 50Ω output. AC coupling is required. Do not DC couple to this pin. |
| 4 | — | HI/ $\overline{\text{LO}}$ | Bias and Bandwidth Control Input. Connect to V _{CC} to set internal bias for higher bandwidth operation (10MHz to 500MHz). Connect to GND to set internal bias for lower bandwidth operation (10MHz to 200MHz) and to reduce overall current consumption. |
| — | 4 | $\overline{\text{IN}}$ | Differential Inverting Buffer Input. High impedance input to buffer amplifier. See <i>Setting The Input Impedance</i> section. |
| 5 | 5 | IN | Differential Noninverting Buffer Input. High impedance to buffer amplifier. See <i>Setting The Input Impedance</i> section. |
| 6 | 6 | V _{CC} | Supply Voltage Input. +2.7V < V _{CC} < +5.5V. |

Detailed Description

Bandwidth Control Circuitry

The MAX2470 features a logic-controlled bias circuit which optimizes the performance for input frequencies from 10MHz to 500MHz (HI/ $\overline{\text{LO}}$ = V_{CC}) and 10MHz to 200MHz (HI/ $\overline{\text{LO}}$ = GND). Operating with HI/ $\overline{\text{LO}}$ = GND significantly reduces power consumption.

Applications Information

Input Considerations

The MAX2470/MAX2471 offer high-impedance inputs, ideal for low-distortion buffering of a VCO. For applications with discrete transistor-based oscillator designs, simply AC-couple the oscillator directly to the inputs. The buffer's high input impedance results in minimal loading on the oscillator. For still higher real input impedance and reduced loading effects, match the inputs with a shunt-L matching circuit followed by a series blocking capacitor. For use with 50Ω VCO modules, terminate the buffer input(s) with a 50Ω shunt resistor followed by a series-blocking capacitor. This provides a very stable 50Ω termination and increases reverse isolation. For those applications needing both high gain and good input match, reactively match the buffer inputs to 50Ω with simple two-element matching circuits followed by a series blocking capacitor.

Output Considerations

The MAX2470 and MAX2471 incorporate fully differential output stages capable of driving an AC-coupled 100Ω differential load or two AC-coupled 50Ω single-ended loads. This is ideal for applications that require the oscillator to drive two application circuits (e.g. mixer and PLL) simultaneously. The high output-to-output isolation ensures minimal interaction between multiple load circuits.

Layout and Power-Supply Bypassing

A properly designed PC board is essential to any RF/microwave circuit. Be sure to use controlled impedance lines on all high-frequency inputs and outputs. Bypass the power supply with decoupling capacitors as close to the V_{CC} pins as possible. For long V_{CC} lines (inductive), it may be necessary to add additional decoupling capacitors located further away from the device package.

Proper grounding of GND is essential. If the PC board uses a topside RF ground, connect GND directly to it. For a board where the ground plane is not on the component side, the best technique is to connect GND to the board with a plated through-hole (via) to the ground plane close to the package.

10MHz to 500MHz VCO Buffer Amplifiers with Differential Outputs

Chip Information

TRANSISTOR COUNT: 67

Package Information

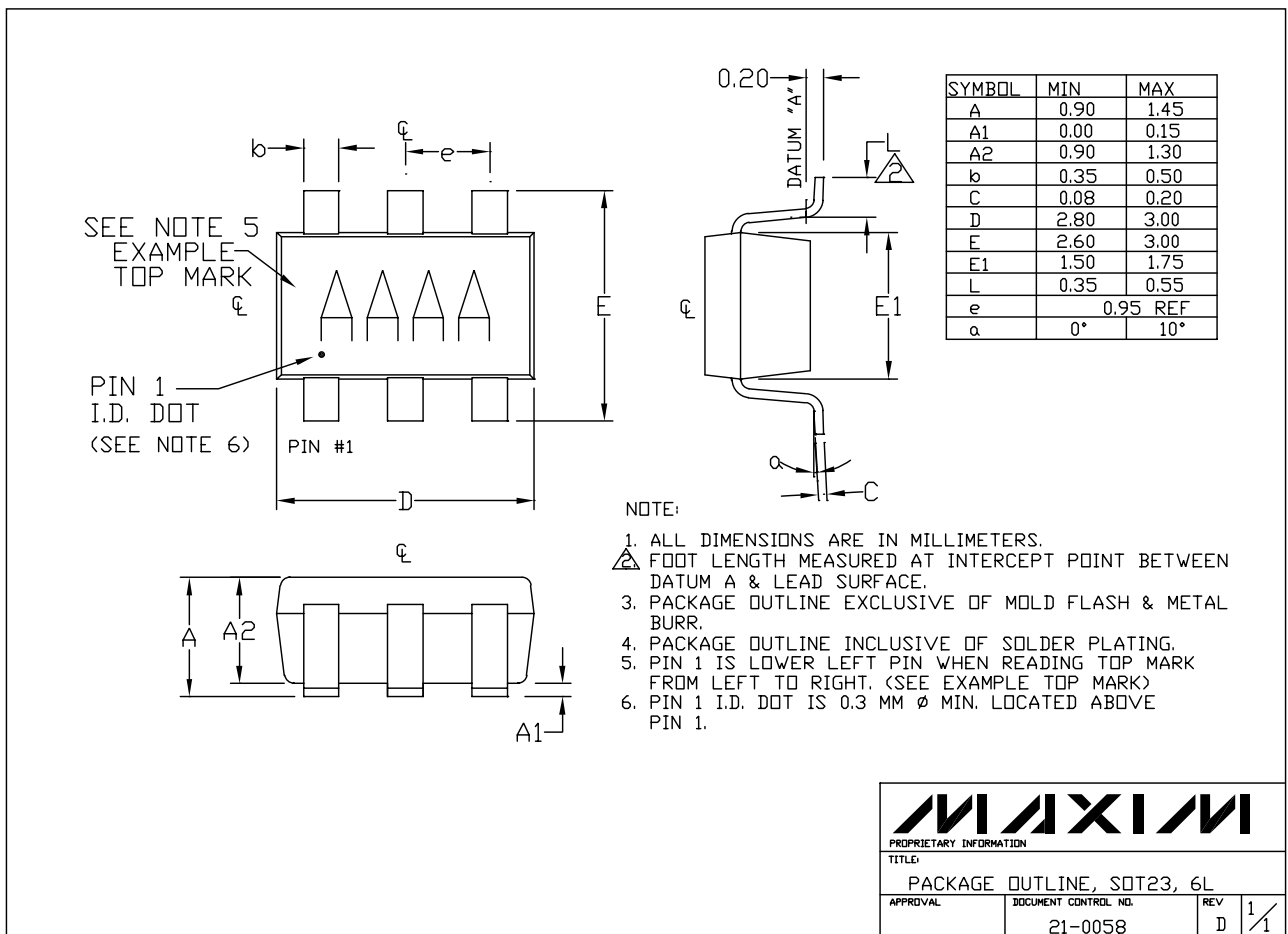

MAX2470/MAX2471

6LSOT23-6L

MAXIM
 PROPRIETARY INFORMATION
 TITLE:
 PACKAGE OUTLINE, SOT23, 6L
 APPROVAL: _____ DOCUMENT CONTROL NO. 21-0058 REV D 1/1

10MHz to 500MHz VCO Buffer Amplifiers with Differential Outputs

NOTES

MAX2470/MAX2471