



MAX6901 Evaluation System/Evaluation Kit

General Description

The MAX6901 evaluation system (EV system) consists of a MAX6901 evaluation kit (EV kit) and a companion Maxim SMBus™ interface board.

The MAX6901 EV kit is an assembled and tested PC board that demonstrates the MAX6901 3-wire serial real-time clock (RTC). This EV kit is intended to demonstrate the functionality and features of the MAX6901 RTC. It is not designed to exercise the MAX6901 at its maximum serial bus interface speed. A typical bus interface speed is in the 90kHz range and depends upon the operating system and computer used.

The Maxim SMBus interface board (MAXSMBus) allows an IBM-compatible PC to use its parallel port to emulate SPI™, 3-wire, and SMBus (2-wire) interfaces. Windows® 95/98-compatible software provides a user-friendly interface to exercise the features of the MAX6901. (**Note:** Windows NT/2000 requires additional driver software; contact the factory.) The program is menu driven and offers a graphic interface with control buttons and status display.

Order the complete EV system (MAX6901EVSYS) for comprehensive evaluation of the MAX6901 using a PC. Order the EV kit (MAX6901EVKIT) if the MAXSMBus module has already been purchased with a previous Maxim EV system, or for custom use in other μ C-based systems.

MAX6901EVSYS Component List

PART	QTY	DESCRIPTION
MAX6901EVKIT	1	MAX6901 EV kit
MAXSMBUS	1	Interface board

Component Suppliers

SUPPLIER	PHONE	FAX
Murata	770-436-1300	770-436-3030
Taiyo Yuden	800-348-2496	847-925-0899
TDK	847-803-6100	847-390-4405

Note: Please indicate you are using the MAX6901 when contacting these manufacturers.

SMBus is a trademark of Intel Corp.

SPI is a trademark of Motorola, Inc.

Windows is a registered trademark of Microsoft Corp.

Features

- ◆ Proven PC Board Layout
- ◆ Low-Voltage Operation
- ◆ Supply-Current Monitoring
- ◆ Fully Assembled and Tested
- ◆ Easy-to-Use Menu-Driven Software
- ◆ Includes: Windows 95/98-Compatible Software (3.5in Floppy Disk) Demo PC Board

Ordering Information

PART	TEMP. RANGE	INTERFACE TYPE
MAX6901EVKIT	0°C to +70°C	User supplied
MAX6901EVSYS	0°C to +70°C	MAXSMBus

Note: The MAX6901 EV kit software is provided with the MAX6901EVKIT. However, to use the software, the MAXSMBus board is required to interface the EV kit to the computer.

MAX6901EV Component List

DESIGNATION	QTY	DESCRIPTION
C1, C2, C3, C6	4	0.1 μ F, 16V X7R ceramic capacitors (0603) Taiyo Yuden EMK107BJ104KA or Murata GRM39X7R104K016 or TDK C1608X7R1C104K
C4, C5	2	10 μ F, 35V capacitors Al Electrolytic
J1	1	2 \times 10 right-angle female receptacle
JU1, JU2	2	2-pin headers
JU3-JU6	0	Not installed
R1	1	49.9k Ω \pm 1% resistor
R2	1	470k Ω \pm 5% resistor
R3	1	100k Ω \pm 5% resistor
U1	1	MAX6901EKA (8-pin SOT23) real-time clock
U2	1	MAX1840EUB (10-pin μ MAX) level translator
U3	1	MAX1615EUK (5-pin SOT23) linear voltage regulator
Y1	1	32.768kHz, 12.5pF quartz crystal
Y2	0	Not installed

Evaluates: MAX6901



MAX6901 Evaluation System/Evaluation Kit

Quick Start

Required Equipment

Before you begin, the following equipment is needed:

- Maxim MAX6901EVKIT and MAXSMBus interface board
- 12VDC power supply (Any supply voltage between +9V and +15V is acceptable.)
- Computer running Windows 95 or 98
- Spare parallel port
- 25-pin I/O extension cable

Procedure

- 1) Carefully connect the boards by aligning the 20-pin connector of the MAX6901 EV kit with the 20-pin header of the MAXSMBus interface board. Gently press them together. The two boards should be flush against each other.

Do not turn on the power until all connections are made.

- 2) Connect the 25-pin I/O extension cable from the computer's parallel port to the MAXSMBus board. The EV kit software uses a loopback connection to confirm that the correct port has been selected.
- 3) Install the EV system software on your computer by running the INSTALL.EXE program on the floppy disk. The program files are copied and icons are created for them in the Windows Start menu.
- 4) Ensure that the jumper settings are in the default position (Table 1).
- 5) Connect the 12VDC power supply to the MAXSMBus board between POS9 and GND. Voltage for the MAX6901 ICs comes from the MAXSMBus board.
- 6) Start the program by opening its icon in the Start menu.
- 7) Click on the Set from Computer's Clock button to write the current time of day into the MAX6901.
- 8) Observe the difference between the computer's time and the MAX6901 time. The offset is calculated by $\text{Offset} = \text{RTC time} - \text{PC time}$. In general, the RTC keeps more accurate time than the PC. To determine long-term accuracy of the RTC, it must be set by and checked against an accurate time source. The easiest way to do this using the MAX6901 EV software is to use an Internet time service to set the PC clock and then set the RTC from the PC clock. This Internet time service can then be used to accurately update the PC

clock regularly for an accurate comparison of the RTC against a known time standard. The National Institute of Standards and Technology (NIST) offers such an Internet time service without charge (<http://www.boulder.nist.gov/timefreq/service/its.htm>).

Note: The MAX6901EVSYS may be unplugged from the parallel port for long-term drift testing.

Detailed Description of Hardware

The MAX6901 (U1) is a real-time clock with RAM. The MAX1840 level translator (U2) is not required for normal operation of the MAX6901, but allows operation at supply voltages down to +2V, while still communicating with the MAXSMBus board, which is using +5V logic levels. See Figure 7 and refer to the MAX6901 data sheet.

Measuring Timekeeping Supply Current

The MAX6901 is in standby mode whenever no commands are being sent. To measure the timekeeping supply current drawn in standby mode, first ensure that the main screen's Cyclic Burst Read checkbox is not checked, disable the 32kHz output by checking the 32kHz Disable checkbox, remove the shunt from JU2, and measure the voltage across R1. A voltage drop of 10mV represents 200nA of timekeeping supply current. For active bus operation (serial bus activity), replace shunt JU2 to prevent excessive voltage drop across resistor R1.

Surface-Mount Crystal

The EV kit comes with a 1.1mm cylindrical tuning fork crystal; however, the PC board layout accommodates an optional surface-mount crystal. Only one crystal may be used.

Table 1. Jumper Functions

JUMPER	POSITION	FUNCTION
JU1	*Closed	$V_L = +5V$
	Open	User-supplied $V_L \leq +5V$
JU2	*Closed	Supply current-sensing resistor R1 is shorted, enabling communication with the RTC.
	Open	Timekeeping supply current can be estimated by measuring voltage across R1. Communication is not possible in this state.

*Asterisk indicates default configuration.

MAX6901 Evaluation System/Evaluation Kit

Table 2. MAXSMBus Connector Signals

PIN	CONNECTOR P1 ON MAXSMBus BOARD	CONNECTOR J1 ON MAX6901 EV KIT
1	+5V	No connection
2	GND	Ground
3	SDA	X_I/O
4	GND	Ground
5	GND	Ground
6	GND	Ground
7	SCL	X_SCLK
8	GND	Ground
9	SMBSUS	X_CS
10	GND	Ground
11	ALERT	No connection
12	GND	Ground
13	ALERT2	No connection
14	GND	Ground
15	OUTA	No connection
16	GND	Ground
17	OUTB	No connection
18	GND	Ground
19	GND	Ground
20	RAW PWR	+9V

Note: Odd-numbered pins are on the outer row. Even-numbered pins are on the inner row.

MAXSMBus Connector

The MAXSMBus board connects to the MAX6901 EV kit in accordance with Table 2.

Evaluation of the MAX6901 at a Lower Voltage

To evaluate the MAX6901 at a lower voltage, remove the shunt from jumper JU1 and apply the desired voltage (+2V to +5V) to the VL pad.

EV Kit Stand-Alone

The MAX6901 EV kit can be connected to a different 3-wire interface with or without level translation.

To connect with level translation, use the pads labeled X_I/O, X_SCLK, and X_CS. Cut the trace-shorting jumper JU6 and connect the 3-wire interface logic voltage to the VCC pad. Remove the shunt from JU1 and apply the desired voltage for the MAX6901 to the VL pad.

To connect without level translation, cut the traces shorting JU3, JU4, and JU5 and use the pads labeled I/O,

SCLK, and CS. Remove the shunt from JU1 and connect the 3-wire interface logic-voltage to the VL pad.

Troubleshooting

Problem: Unable to communicate while measuring supply current.

JU2 must be closed to enable communication.

Problem: Initial date POR value of RTC is 01-JAN-2070.

RTC evaluation software was started. RTC time was set from computer clock. RTC was powered down. RTC evaluation software remained running and then RTC was powered back up. RTC evaluation software only reads the Century register when time is set from the computer clock or when the software is initially launched. Stop Cyclic Burst Read. Do a single read of the Century register. Continue by starting the Cyclic Burst Read.

Detailed Description of Software

The evaluation software provides access to all registers. The main timekeeping registers appear in the main screen, with other screens accessible from the View menu. To write to a single register, click on the appropriate register select button, set the desired value, and then click the Write button. To read a register, click on the appropriate register select button, and then click the Read button. Cyclic Burst Read should be disabled before a read or write to a single register.

Main Screen

The Read button reads the most recently selected timekeeping register. The Write button writes the most recently selected timekeeping register. The Burst Read button performs a Burst Read from the timekeeping registers (except Century). The Burst Write button performs a Burst Write to the timekeeping registers (except Century). The Set from Computer's Clock button writes the PC's time into the MAX6901. The Cyclic Burst Read checkbox tells the software to perform a Burst Read from the timekeeping registers, at a rate of approximately four times per second. Updates are shown in the register display, along with the difference between MAX6901 time and the host PC's time. **Note:** Cyclic Burst Read should be disabled before a read or write to a single register. Figure 1 shows the main screen.

The Hour register setting can be switched from 12hr format to 24hr format by clicking the -->24 button.

Checking the 32kHz Disable checkbox disables the 32kHz output (pin 5) on the MAX6901. A checkmark corresponds to a logic 1 for bit 7 of the Seconds register.

MAX6901 Evaluation System/Evaluation Kit

Evaluates: MAX6901

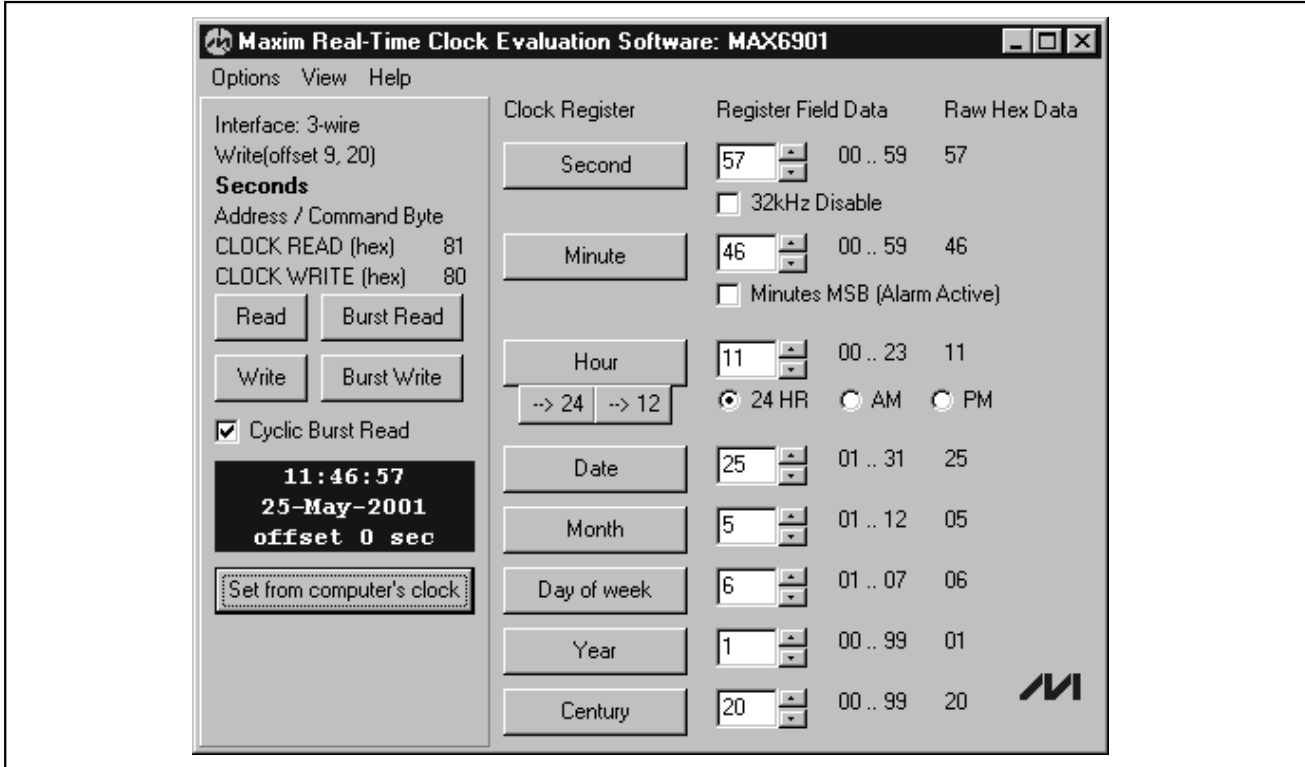

Figure 1. Main Screen

RAM Screen

The Single Read button reads the most recently selected RAM location. The Single Write button writes the most recently selected RAM location. The Burst Read button performs a Burst Read from the entire RAM. The Burst Write button performs a Burst Write to the RAM. Normally, all 31 locations are read, but the Burst Write length can be reduced. The Burst Write always begins with RAM location 0. The Preset Data button performs a Burst Write to the RAM, setting all data to the same value. **Note:** Cyclic Burst Read should be disabled before reading or writing to RAM. Figure 2 is the RAM screen.

Alarm Thresholds Screen

The Read button reads the most recently selected alarm threshold register. The Write button writes the most recently selected alarm threshold register.

The Hour register setting can be switched from 12hr format to 24hr format by clicking the -->24 button.

Note: Cyclic Burst Read should be disabled before a read or write to a single register. Figure 3 is the Alarm Thresholds screen.

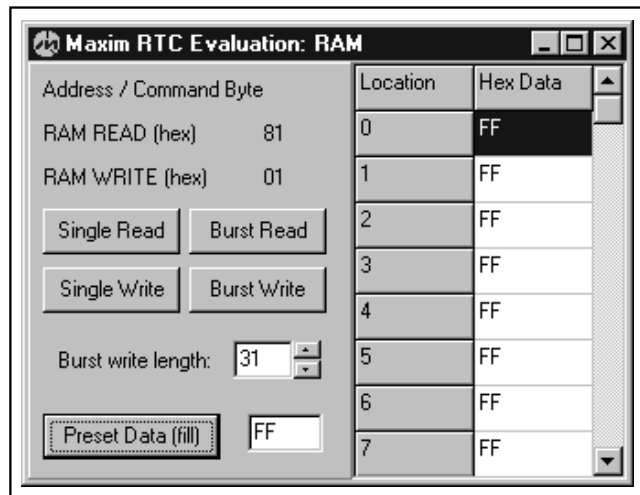

Figure 2. RAM Screen

MAX6901 Evaluation System/Evaluation Kit

Evaluates: MAX6901

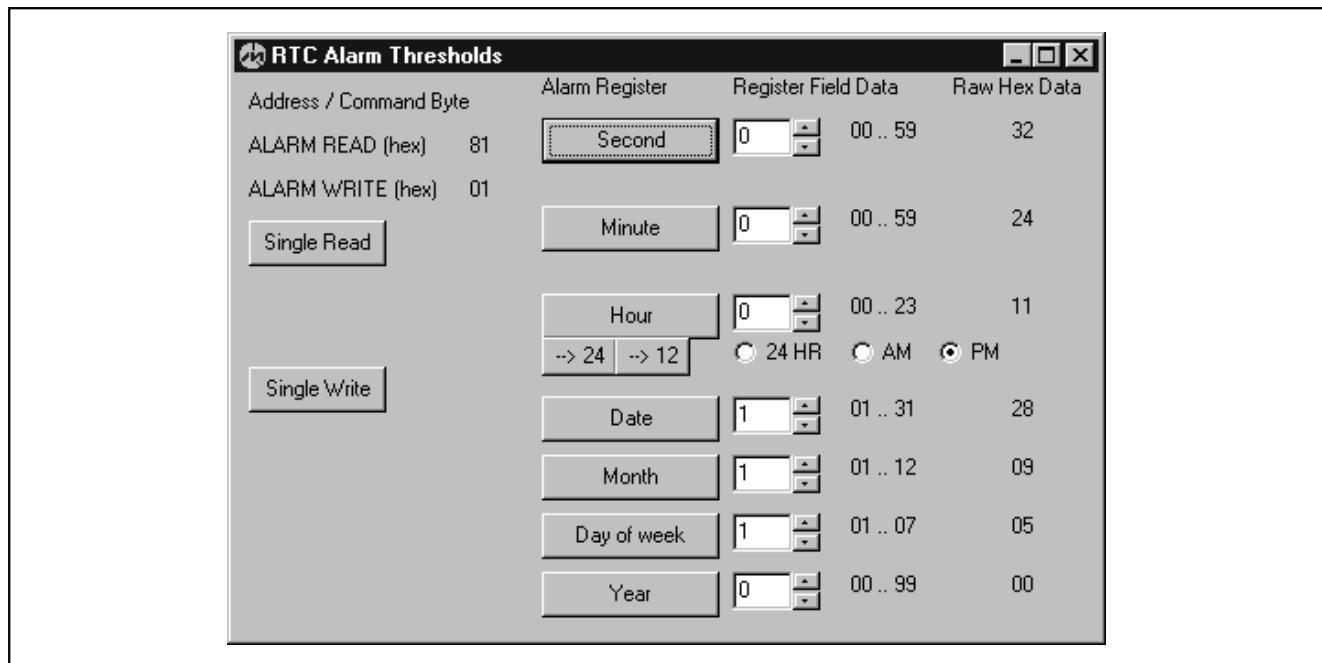

Figure 3. Alarm Thresholds Screen

Setup Screen

Each setup register is represented by a group of eight checkboxes, one for each bit. A checkmark indicates that the corresponding bit is a logic 1. The Read button updates the most recently selected setup register's checkboxes. The Write button writes the most recently selected setup register. **Note:** Cyclic Burst Read should be disabled before a read or write to a single register. Figure 4 is the Setup screen.

Auxiliary Functions

SPI/3-Wire Diagnostic

The transition from evaluation to custom software development requires access to the low-level interface. Access the SPI/3-wire diagnostic from the main screen's View menu. The SPI/3-Wire Diagnostic screen allows you to send SPI or 3-wire commands, or manipulate the parallel port pins directly. Each of the 25 parallel port pins is represented by a checkbox. A checkmark means that the corresponding pin is at a logic high level. Pins that are inputs to the PC are grayed.

The Bit Banging SPI Diagnostic transmits data using synchronous serial format (similar to Motorola's 68HC11 SPI interface). The SPI interface sends and

receives data simultaneously on separate pins. Parallel port pin 2 drives the SCLK, pin 1 drives DIN, pin 4 drives CS, and pin 11 senses DOUT.

When the software is communicating through the MAXSMBus board DOUT, CS, and SCLK are inverted. DIN is not inverted.

The signals come out of the MAXSMBus at connector P1; DOUT is pin 3, CS is pin 9, SCLK is pin 7, and DIN is pin 15.

The 3-wire interface uses a bidirectional data pin. The least-significant bit (LSB) is transmitted first, and (CPOL = 1, CPHA = 0) mode is used. Parallel port pin 2 drives SCLK, pin 11 drives I/O, and pin 4 drives CS.

When the software is communicating through the MAXSMBus board SCLK, I/O and CS are inverted.

The signals come out of the MAXSMBus at connector P1; SCLK is pin 7, CS is pin 9, and I/O is pin 3.

When using this software, the data is relative to the parallel port. However, there are checkboxes that allow the signals to be inverted to accommodate the MAXSMBus board. **Note:** Disable Cyclic Burst Read when using the SPI/3-wire diagnostic utility. Figure 5 is the SPI/3-Wire Diagnostic screen.

MAX6901 Evaluation System/Evaluation Kit

Evaluates: MAX6901

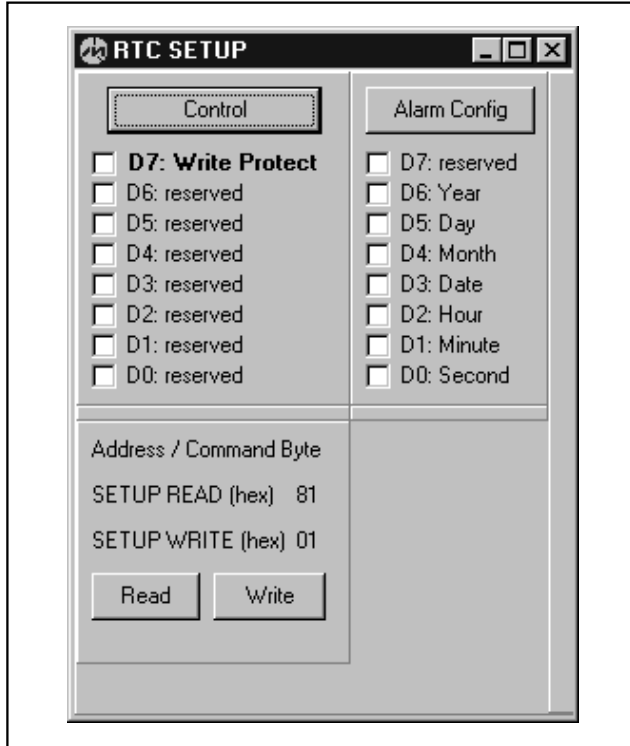

Figure 4. Setup Screen

2-Wire Diagnostic

The transition from evaluation to custom software development requires access to the low-level interface. Access the 2-wire diagnostic from the main screen's View menu. The 2-wire Diagnostic screen allows you to send general-purpose SMBus commands. The Hunt for Active Devices button scans the entire address space, reporting each address that is acknowledged. The two most-often-used protocols are SMBusReadByte and SMBusWriteByte. SMBusWriteByte transmits the device address, a command or register select byte, and 1 byte of data. SMBusReadByte transmits the device address, a Command or Register Select Byte, then retransmits the device address and reads 1 byte.

Parallel port pin 2 drives the SMBCLK, pin 3 drives the SMBDATA, and pin 11 senses SMBDATA.

The signals are inverted through the MAXSMBus board at connector P1; the signals come out of the MAXSMBus at connector P1 SMBCLK is pin 7, and SMBDATA is pin 3. The 2-wire interface diagnostic software accounts for the logic inversion through the MAXSMBus board. **Note:** Disable Cyclic Burst Read when using the 2-wire diagnostic utility. Figure 6 shows the 2-Wire Diagnostic screen.

MAX6901 Evaluation System/Evaluation Kit

Evaluates: MAX6901

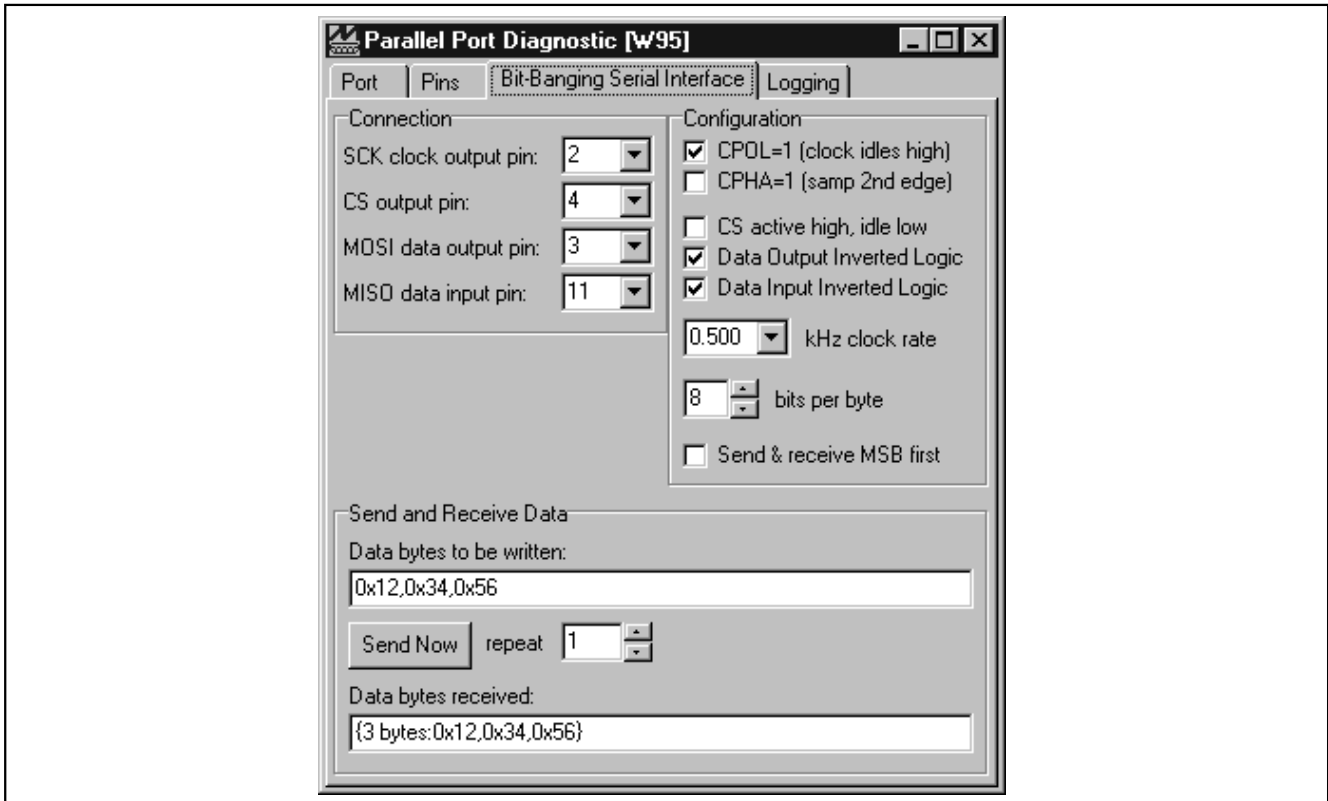

Figure 5. SPI/3-Wire Diagnostic Screen

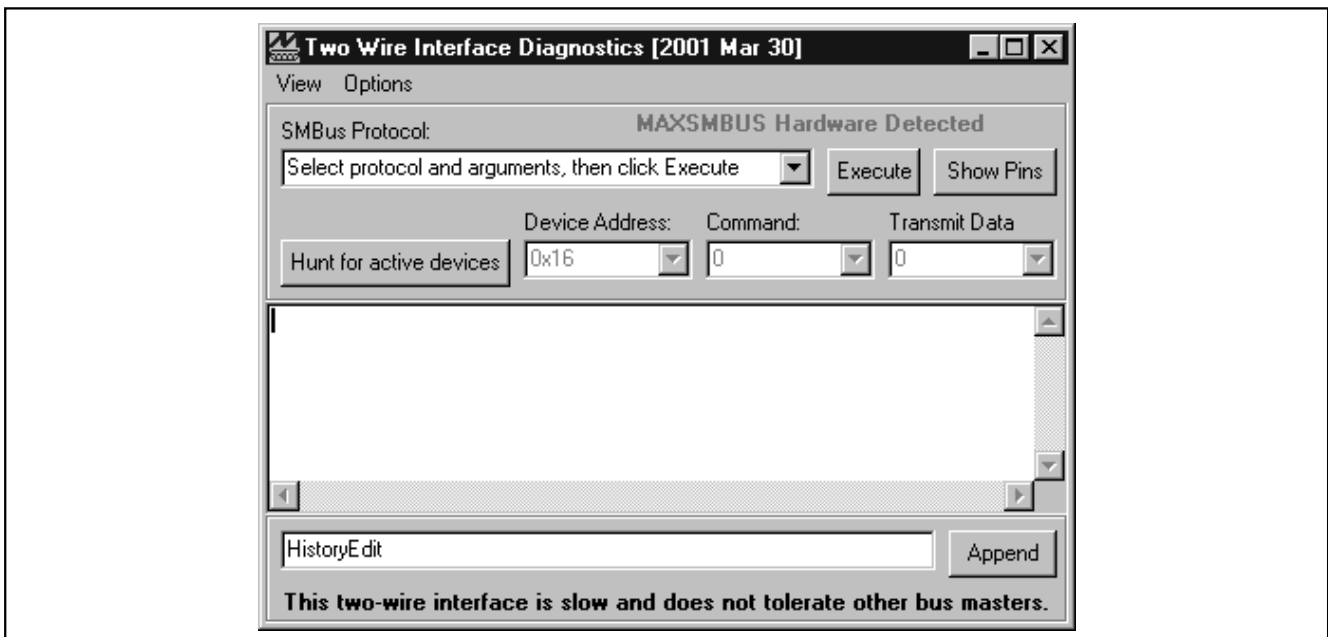

Figure 6. 2-Wire Diagnostic Screen

MAX6901 Evaluation System/Evaluation Kit

Evaluates: MAX6901

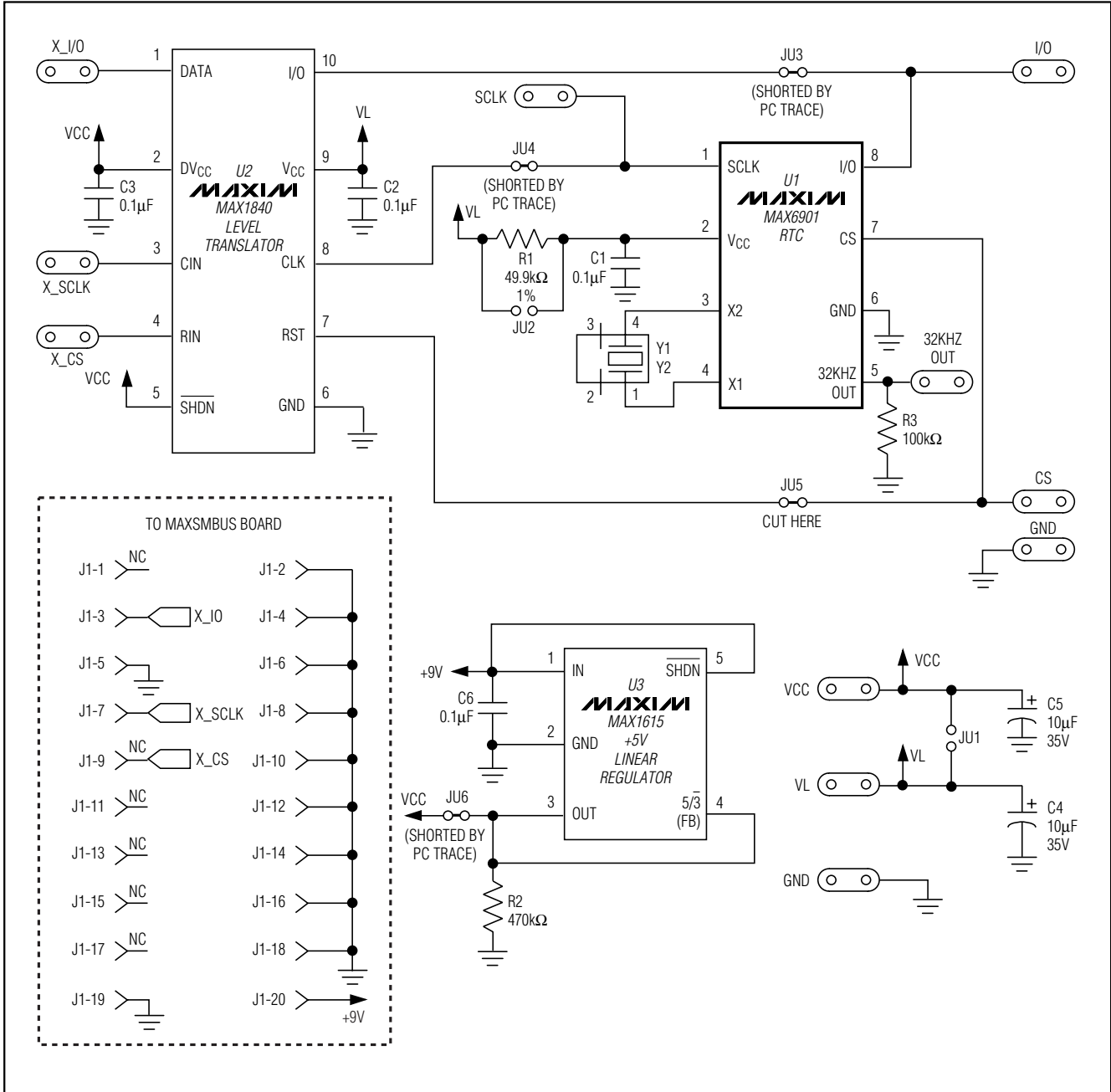

Figure 7. MAX6901 EV Kit Schematic

MAX6901 Evaluation System/Evaluation Kit

Evaluates: MAX6901

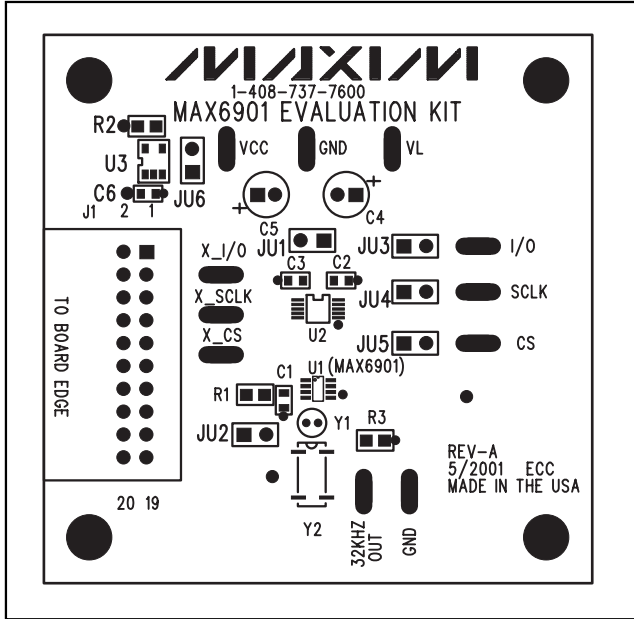

Figure 8. MAX6901 EV Kit Component Placement Guide—Component Side

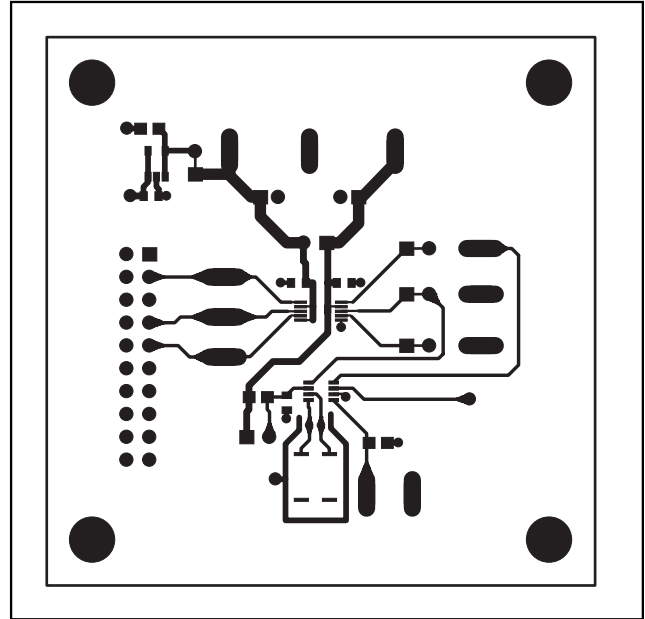

Figure 9. MAX6901 EV Kit PC Board Layout—Component Side

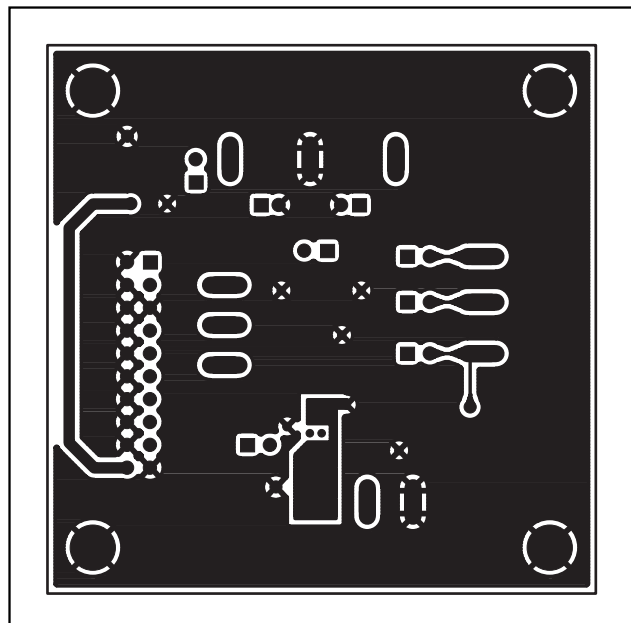

Figure 10. MAX6901 EV Kit PC Board Layout—Solder Side

Maxim cannot assume responsibility for use of any circuitry other than circuitry entirely embodied in a Maxim product. No circuit patent licenses are implied. Maxim reserves the right to change the circuitry and specifications without notice at any time.

Maxim Integrated Products, 120 San Gabriel Drive, Sunnyvale, CA 94086 408-737-7600 _____ 9