

OPA130
OPA2130
OPA4130

Low Power, Precision FET-INPUT OPERATIONAL AMPLIFIERS

FEATURES

- **LOW QUIESCENT CURRENT:** 530 μ A/amp
- **LOW OFFSET VOLTAGE:** 1mV max
- **HIGH OPEN-LOOP GAIN:** 120dB min
- **HIGH CMRR:** 90dB min
- **FET INPUT:** $I_b = 20$ pA max
- **EXCELLENT BANDWIDTH:** 1MHz
- **WIDE SUPPLY RANGE:** ± 2.25 to ± 18 V
- **SINGLE, DUAL, AND QUAD VERSIONS**

DESCRIPTION

The OPA130 series of FET-input op amps combine precision dc performance with low quiescent current. Single, dual, and quad versions have identical specifications for maximum design flexibility. They are ideal for general-purpose, portable, and battery operated applications, especially with high source impedance.

OPA130 op amps are easy to use and free from phase inversion and overload problems often found in common FET-input op amps. Input cascode circuitry provides excellent common-mode rejection and maintains low input bias current over its wide input voltage range. OPA130 series op amps are stable in unity gain and provide excellent dynamic behavior over a wide range of load conditions, including high load capacitance. Dual and quad designs feature completely independent circuitry for lowest crosstalk and freedom from interaction, even when overdriven or overloaded.

Single and dual versions are available in 8-pin DIP and SO-8 surface-mount packages. Quad is available in 14-pin DIP and SO-14 surface-mount packages. All are specified for -40°C to $+85^{\circ}\text{C}$ operation.

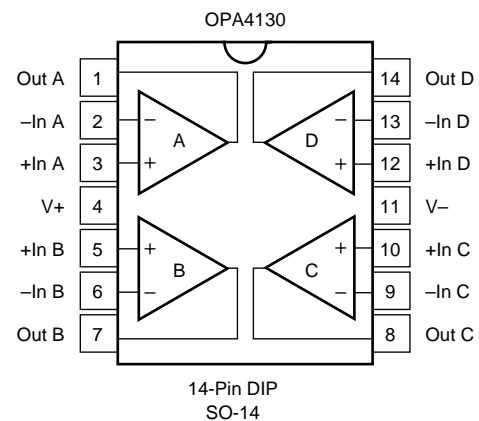
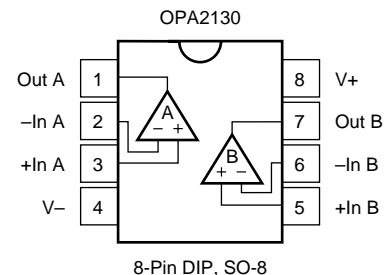
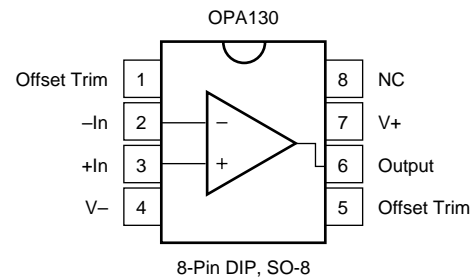

SPECIFICATIONS

At $T_A = +25^\circ\text{C}$, $V_S = \pm 15\text{V}$, and $R_L = 10\text{k}\Omega$, unless otherwise noted.

PARAMETER	CONDITION	OPA130PA, UA OPA2130PA, UA OPA4130PA, UA			UNITS
		MIN	TYP	MAX	
OFFSET VOLTAGE Input Offset Voltage vs Temperature ⁽¹⁾ vs Power Supply Channel Separation (dual and quad)	Operating Temperature Range $V_S = \pm 2.25\text{V to } \pm 18\text{V}$		± 0.2 ± 2 2 0.3	± 1 ± 10 20	mV $\mu\text{V}/^\circ\text{C}$ $\mu\text{V}/\text{V}$ $\mu\text{V}/\text{V}$
INPUT BIAS CURRENT ⁽²⁾ Input Bias Current vs Temperature Input Offset Current	$V_{\text{CM}} = 0\text{V}$ $V_{\text{CM}} = 0\text{V}$		See Typical Curve ± 2	± 5 ± 10 ± 20	pA pA
NOISE Input Voltage Noise Noise Density, $f = 10\text{Hz}$ $f = 100\text{Hz}$ $f = 1\text{kHz}$ $f = 10\text{kHz}$ Current Noise Density, $f = 1\text{kHz}$			30 18 16 16 4		$\text{nV}/\sqrt{\text{Hz}}$ $\text{nV}/\sqrt{\text{Hz}}$ $\text{nV}/\sqrt{\text{Hz}}$ $\text{nV}/\sqrt{\text{Hz}}$ $\text{fA}/\sqrt{\text{Hz}}$
INPUT VOLTAGE RANGE Common-Mode Voltage Range, Positive Negative Common-Mode Rejection	$V_{\text{CM}} = -13\text{V to } +13\text{V}$	$(V^+)-2$ $(V^-)+2$ 90	$(V^+)-1.5$ $(V^-)+1.2$ 105		V V dB
INPUT IMPEDANCE Differential Common-Mode	$V_{\text{CM}} = -13\text{V to } +13\text{V}$		$10^{13} \parallel 1$ $10^{13} \parallel 3$		$\Omega \parallel \text{pF}$ $\Omega \parallel \text{pF}$
OPEN-LOOP GAIN Open-loop Voltage Gain	$V_O = -13.8\text{V to } +13\text{V}$ $R_L = 2\text{k}\Omega$, $V_O = -13\text{V to } +12\text{V}$	120 120	135 135		dB dB
FREQUENCY RESPONSE Gain-Bandwidth Product Slew Rate Settling Time: 0.1% 0.01% Overload Recovery Time Total Harmonic Distortion + Noise	$G = 1$, 10V Step, $C_L = 100\text{pF}$ $G = 1$, 10V Step, $C_L = 100\text{pF}$ $G = 1$, $V_{\text{IN}} = \pm 15\text{V}$ 1kHz, $G = 1$, $V_O = 3.5\text{Vrms}$		1 2 5.5 7 2 0.0003		MHz V/ μs μs μs μs %
OUTPUT Voltage Output, Positive Negative Positive Negative Short-Circuit Current Capacitive Load Drive (Stable Operation)	$R_L = 2\text{k}\Omega$ $R_L = 2\text{k}\Omega$	$(V^+)-2$ $(V^-)+1.2$ $(V^+)-3$ $(V^-)+2$	$(V^+)-1.5$ $(V^-)+1$ $(V^+)-2.5$ $(V^-)+1.5$ ± 18 10		V V V V mA nF
POWER SUPPLY Specified Operating Voltage Operating Voltage Range Quiescent Current (per amplifier)	$I_O = 0$	± 2.25	± 15 ± 530	± 18 ± 650	V V μA
TEMPERATURE RANGE Operating Range Storage Thermal Resistance, θ_{JA} 8-Pin DIP SO-8 Surface-Mount 14-Pin DIP SO-14 Surface-Mount		-40 -40		+85 +125	$^\circ\text{C}$ $^\circ\text{C}$ $^\circ\text{C}/\text{W}$ $^\circ\text{C}/\text{W}$ $^\circ\text{C}/\text{W}$ $^\circ\text{C}/\text{W}$

NOTES: (1) Guaranteed by wafer test. (2) High-speed test at $T_J = 25^\circ\text{C}$.

The information provided herein is believed to be reliable; however, BURR-BROWN assumes no responsibility for inaccuracies or omissions. BURR-BROWN assumes no responsibility for the use of this information, and all use of such information shall be entirely at the user's own risk. Prices and specifications are subject to change without notice. No patent rights or licenses to any of the circuits described herein are implied or granted to any third party. BURR-BROWN does not authorize or warrant any BURR-BROWN product for use in life support devices and/or systems.

ABSOLUTE MAXIMUM RATINGS

Supply Voltage, V+ to V-	36V
Input Voltage	(V-) -0.7V to (V+) +0.7V
Output Short-Circuit ⁽¹⁾	Continuous
Operating Temperature	-40°C to +125°C
Storage Temperature	-40°C to +125°C
Junction Temperature	150°C
Lead Temperature (soldering, 10s)	300°C

NOTE: (1) Short-circuit to ground, one amplifier per package.

PACKAGE/ORDERING INFORMATION

PRODUCT	PACKAGE	PACKAGE DRAWING NUMBER ⁽¹⁾	TEMPERATURE RANGE
Single			
OPA130PA	8-Pin Plastic DIP	006	-40°C to +85°C
OPA130UA	SO-8 Surface-Mount	182	-40°C to +85°C
Dual			
OPA2130PA	8-Pin Plastic DIP	006	-40°C to +85°C
OPA2130UA	SO-8 Surface-Mount	182	-40°C to +85°C
Quad			
OPA4130PA	14-Pin Plastic DIP	010	-40°C to +85°C
OPA4130UA	SO-14 Surface-Mount	235	-40°C to +85°C

NOTE: (1) For detailed drawing and dimension table, please see end of data sheet, or Appendix C of Burr-Brown IC Data Book.



ELECTROSTATIC DISCHARGE SENSITIVITY

This integrated circuit can be damaged by ESD. Burr-Brown recommends that all integrated circuits be handled with appropriate precautions. Failure to observe proper handling and installation procedures can cause damage.

ESD damage can range from subtle performance degradation to complete device failure. Precision integrated circuits may be more susceptible to damage because very small parametric changes could cause the device not to meet its published specifications.

TYPICAL PERFORMANCE CURVES

At $T_A = +25^\circ\text{C}$, $V_S = \pm 15\text{V}$, and $R_L = 10\text{k}\Omega$, unless otherwise noted.

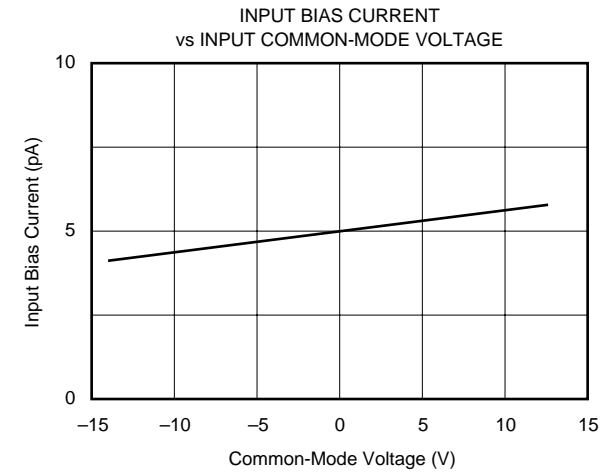
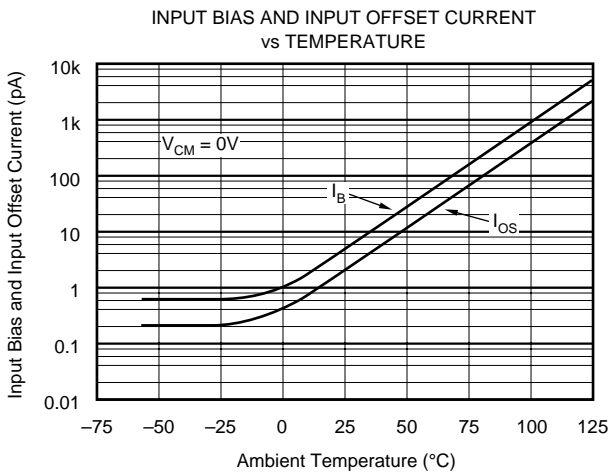
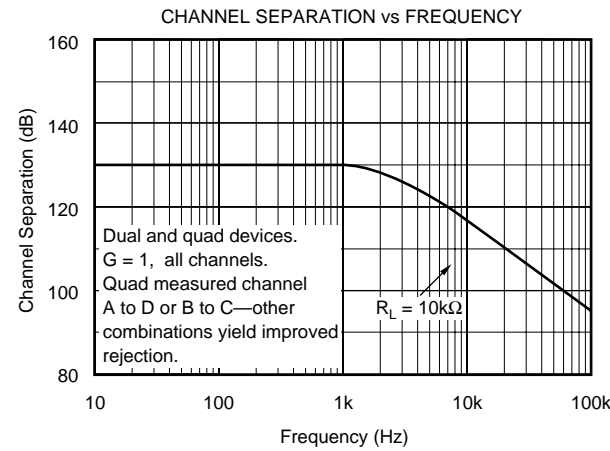
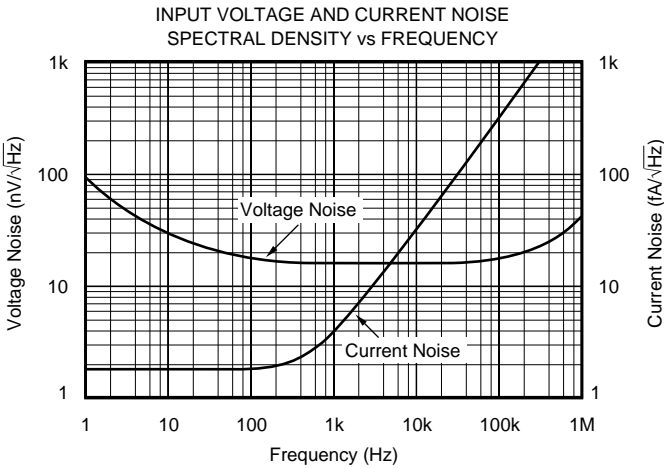
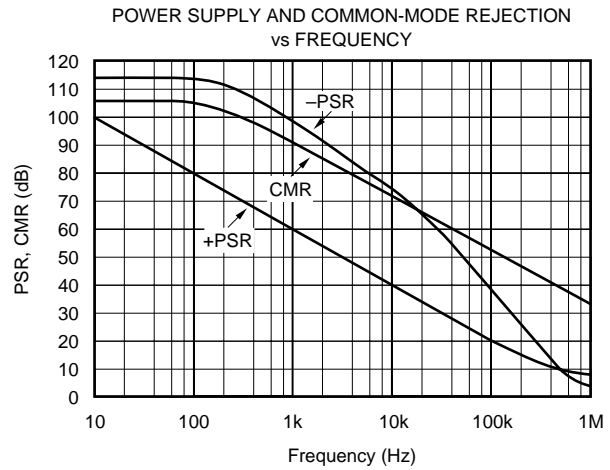
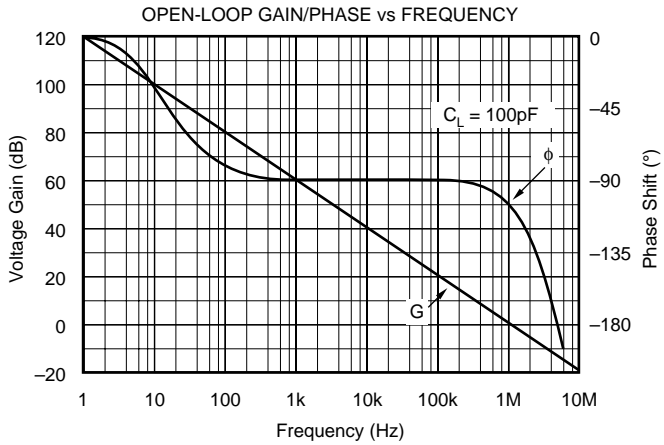

TYPICAL PERFORMANCE CURVES (CONT)

At $T_A = +25^\circ\text{C}$, $V_S = \pm 15\text{V}$, and $R_L = 10\text{k}\Omega$, unless otherwise noted.

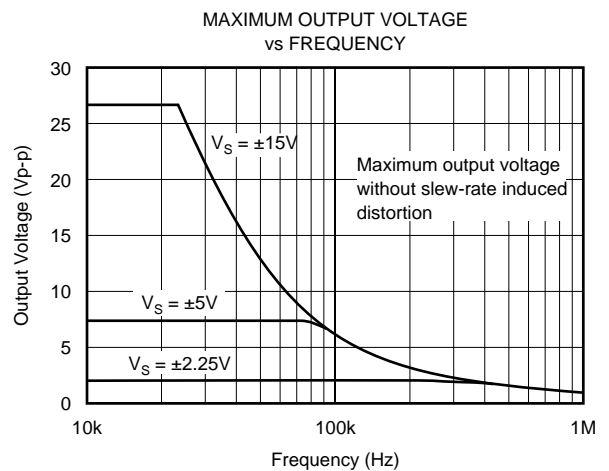
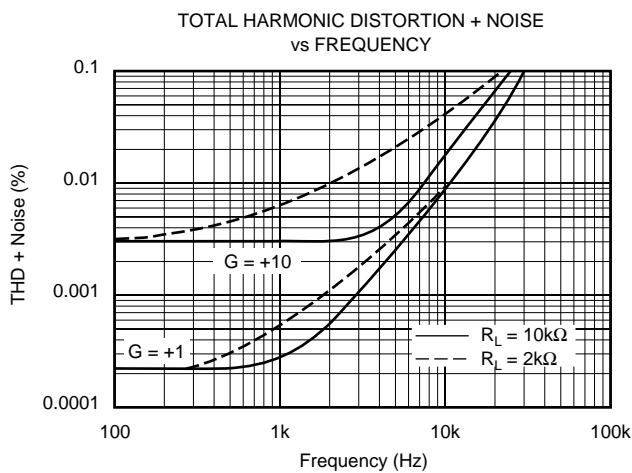
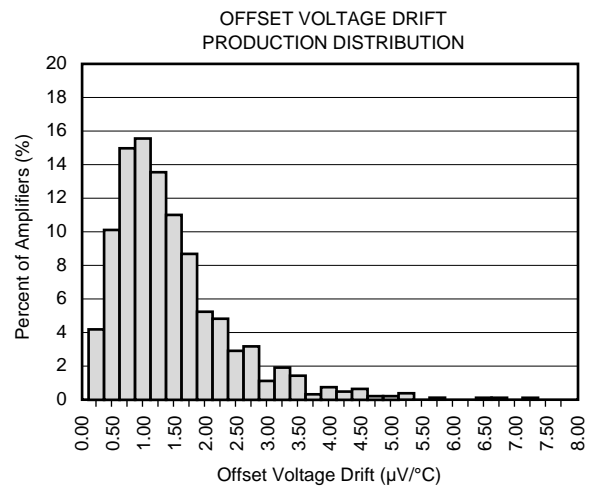
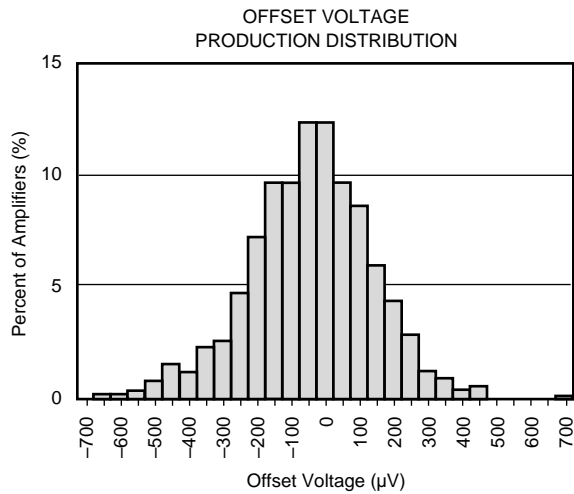
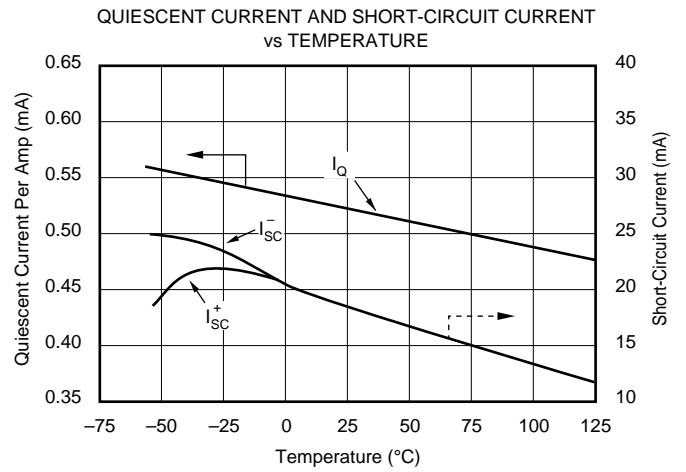
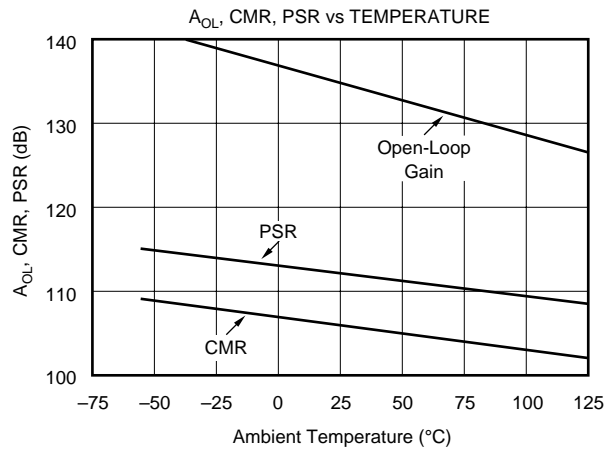

TYPICAL PERFORMANCE CURVES (CONT)

At $T_A = +25^\circ\text{C}$, $V_S = \pm 15\text{V}$, and $R_L = 10\text{k}\Omega$, unless otherwise noted.

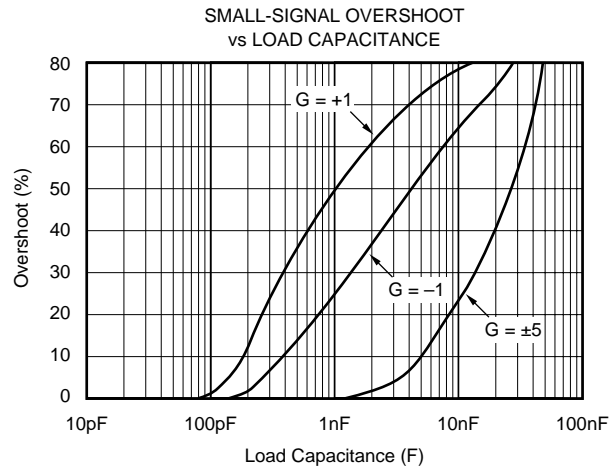
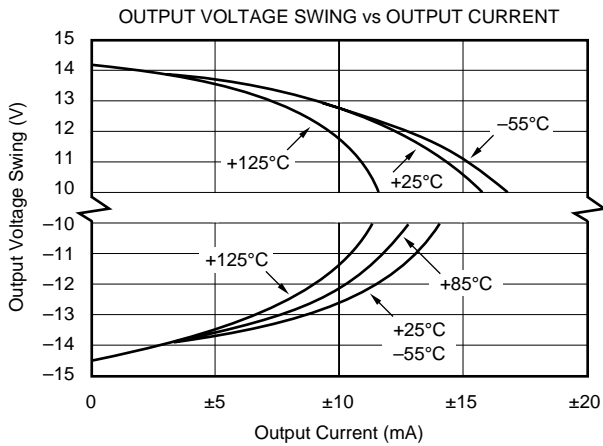
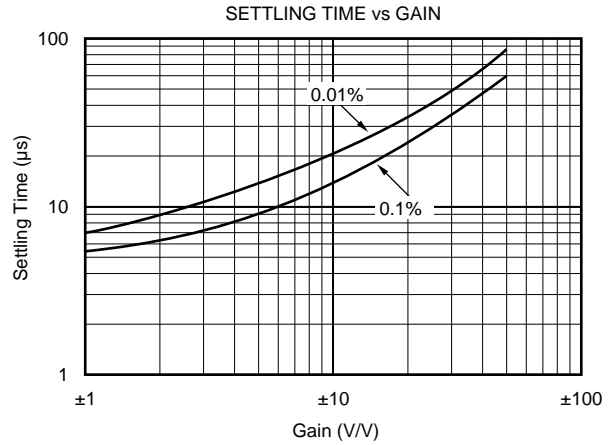
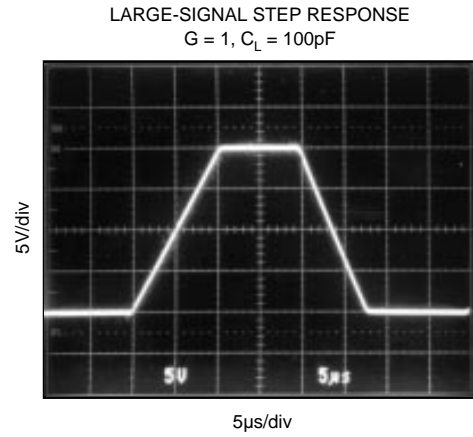
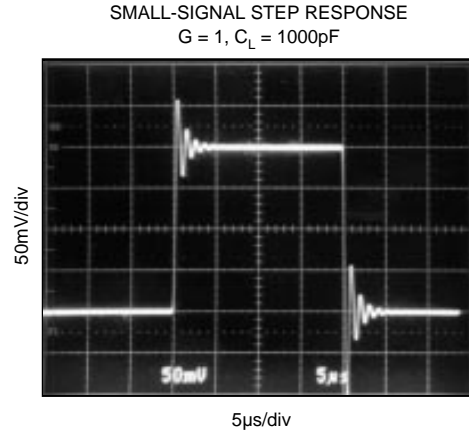
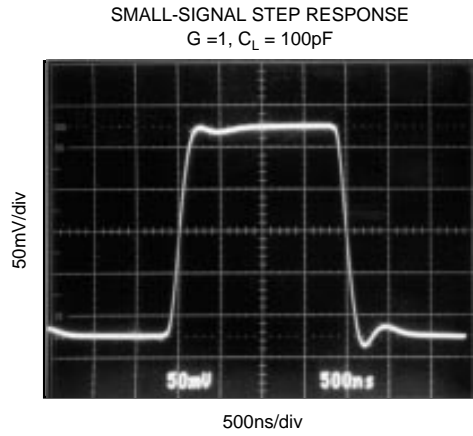

APPLICATIONS INFORMATION

OPA130 series op amps are unity-gain stable and suitable for a wide range of general-purpose applications. Power supply pins should be bypassed with 10nF ceramic capacitors or larger.

OPA130 op amps are free from unexpected output phase-reversal common with FET op amps. Many FET-input op amps exhibit phase-reversal of the output when the input common-mode voltage range is exceeded. This can occur in voltage-follower circuits, causing serious problems in control loop applications. OPA130 series op amps are free from this undesirable behavior. All circuitry is completely independent in dual and quad versions, assuring normal behavior when one amplifier in a package is overdriven or short-circuited.

OPERATING VOLTAGE

OPA130 series op amps operate with power supplies from $\pm 2.25\text{V}$ to $\pm 18\text{V}$ with excellent performance. Although specifications are production tested with $\pm 15\text{V}$ supplies, most behavior remains unchanged throughout the full operating voltage range. Parameters which vary significantly with operating voltage are shown in the typical performance curves.

OFFSET VOLTAGE TRIM

Offset voltage of OPA130 series amplifiers is laser trimmed and usually requires no user adjustment. The OPA130 (single op amp version) provides offset voltage trim connections on pins 1 and 5. Offset voltage can be adjusted by connecting a potentiometer as shown in Figure 1. This adjustment should be used only to null the offset of the op amp, not to adjust system offset or offset produced by the signal source. Nulling offset that is not produced by the amplifier will change the offset voltage drift behavior of the op amp.

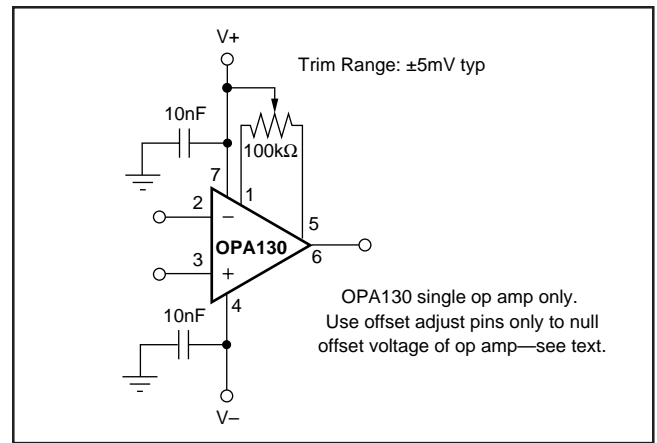

FIGURE 1. OPA130 Offset Voltage Trim Circuit.

INPUT BIAS CURRENT

The input bias current is approximately 5pA at room temperature and increases with temperature as shown in the typical performance curve “Input Bias Current vs Temperature.”

Input stage cascode circuitry assures that the input bias current remains virtually unchanged throughout the full input common-mode range of the OPA130. See the typical performance curve “Input Bias Current vs Common-Mode Voltage.”

PACKAGING INFORMATION

Orderable Device	Status ⁽¹⁾	Package Type	Package Drawing	Pins	Package Qty	Eco Plan ⁽²⁾	Lead/Ball Finish	MSL Peak Temp ⁽³⁾
OPA130PA	OBSOLETE	PDIP	P	8		None	Call TI	Call TI
OPA130UA	ACTIVE	SOIC	D	8	100	None	CU SNPB	Level-2-220C-1 YEAR
OPA130UA/2K5	ACTIVE	SOIC	D	8	2500	None	CU SNPB	Level-2-220C-1 YEAR
OPA2130PA	OBSOLETE	PDIP	P	8		None	Call TI	Call TI
OPA2130UA	ACTIVE	SOIC	D	8	100	None	CU SNPB	Level-3-220C-168 HR
OPA2130UA/2K5	ACTIVE	SOIC	D	8	2500	None	CU SNPB	Level-3-220C-168 HR
OPA4130PA	OBSOLETE	PDIP	N	14		None	Call TI	Call TI
OPA4130UA	ACTIVE	SOIC	D	14	58	None	CU SNPB	Level-3-220C-168 HR
OPA4130UA/2K5	ACTIVE	SOIC	D	14	2500	None	CU SNPB	Level-3-220C-168 HR

⁽¹⁾ The marketing status values are defined as follows:

ACTIVE: Product device recommended for new designs.

LIFEBUY: TI has announced that the device will be discontinued, and a lifetime-buy period is in effect.

NRND: Not recommended for new designs. Device is in production to support existing customers, but TI does not recommend using this part in a new design.

PREVIEW: Device has been announced but is not in production. Samples may or may not be available.

OBSOLETE: TI has discontinued the production of the device.

⁽²⁾ Eco Plan - May not be currently available - please check <http://www.ti.com/productcontent> for the latest availability information and additional product content details.

None: Not yet available Lead (Pb-Free).

Pb-Free (RoHS): TI's terms "Lead-Free" or "Pb-Free" mean semiconductor products that are compatible with the current RoHS requirements for all 6 substances, including the requirement that lead not exceed 0.1% by weight in homogeneous materials. Where designed to be soldered at high temperatures, TI Pb-Free products are suitable for use in specified lead-free processes.

Green (RoHS & no Sb/Br): TI defines "Green" to mean "Pb-Free" and in addition, uses package materials that do not contain halogens, including bromine (Br) or antimony (Sb) above 0.1% of total product weight.

⁽³⁾ MSL, Peak Temp. -- The Moisture Sensitivity Level rating according to the JEDEC industry standard classifications, and peak solder temperature.

Important Information and Disclaimer: The information provided on this page represents TI's knowledge and belief as of the date that it is provided. TI bases its knowledge and belief on information provided by third parties, and makes no representation or warranty as to the accuracy of such information. Efforts are underway to better integrate information from third parties. TI has taken and continues to take reasonable steps to provide representative and accurate information but may not have conducted destructive testing or chemical analysis on incoming materials and chemicals. TI and TI suppliers consider certain information to be proprietary, and thus CAS numbers and other limited information may not be available for release.

In no event shall TI's liability arising out of such information exceed the total purchase price of the TI part(s) at issue in this document sold by TI to Customer on an annual basis.

IMPORTANT NOTICE

Texas Instruments Incorporated and its subsidiaries (TI) reserve the right to make corrections, modifications, enhancements, improvements, and other changes to its products and services at any time and to discontinue any product or service without notice. Customers should obtain the latest relevant information before placing orders and should verify that such information is current and complete. All products are sold subject to TI's terms and conditions of sale supplied at the time of order acknowledgment.

TI warrants performance of its hardware products to the specifications applicable at the time of sale in accordance with TI's standard warranty. Testing and other quality control techniques are used to the extent TI deems necessary to support this warranty. Except where mandated by government requirements, testing of all parameters of each product is not necessarily performed.

TI assumes no liability for applications assistance or customer product design. Customers are responsible for their products and applications using TI components. To minimize the risks associated with customer products and applications, customers should provide adequate design and operating safeguards.

TI does not warrant or represent that any license, either express or implied, is granted under any TI patent right, copyright, mask work right, or other TI intellectual property right relating to any combination, machine, or process in which TI products or services are used. Information published by TI regarding third-party products or services does not constitute a license from TI to use such products or services or a warranty or endorsement thereof. Use of such information may require a license from a third party under the patents or other intellectual property of the third party, or a license from TI under the patents or other intellectual property of TI.

Reproduction of information in TI data books or data sheets is permissible only if reproduction is without alteration and is accompanied by all associated warranties, conditions, limitations, and notices. Reproduction of this information with alteration is an unfair and deceptive business practice. TI is not responsible or liable for such altered documentation.

Resale of TI products or services with statements different from or beyond the parameters stated by TI for that product or service voids all express and any implied warranties for the associated TI product or service and is an unfair and deceptive business practice. TI is not responsible or liable for any such statements.

Following are URLs where you can obtain information on other Texas Instruments products and application solutions:

Products		Applications	
Amplifiers	amplifier.ti.com	Audio	www.ti.com/audio
Data Converters	dataconverter.ti.com	Automotive	www.ti.com/automotive
DSP	dsp.ti.com	Broadband	www.ti.com/broadband
Interface	interface.ti.com	Digital Control	www.ti.com/digitalcontrol
Logic	logic.ti.com	Military	www.ti.com/military
Power Mgmt	power.ti.com	Optical Networking	www.ti.com/opticalnetwork
Microcontrollers	microcontroller.ti.com	Security	www.ti.com/security
		Telephony	www.ti.com/telephony
		Video & Imaging	www.ti.com/video
		Wireless	www.ti.com/wireless

Mailing Address: Texas Instruments
Post Office Box 655303 Dallas, Texas 75265