

- Available in the Texas Instruments NanoStar™ and NanoFree™ Packages
- Optimized for 1.8-V Operation and Is 3.6-V I/O Tolerant to Support Mixed-Mode Signal Operation
- I<sub>off</sub> Supports Partial-Power-Down Mode Operation
- Sub 1-V Operable
- Max t<sub>pd</sub> of 1.7 ns at 1.8 V
- Low Power Consumption, 10 μA at 1.8 V
- ±8-mA Output Drive at 1.8 V
- Latch-Up Performance Exceeds 100 mA Per JESD 78, Class II
- ESD Protection Exceeds JESD 22
  - 2000-V Human-Body Model (A114-A)
  - 200-V Machine Model (A115-A)
  - 1000-V Charged-Device Model (C101)

DBV OR DCK PACKAGE  
(TOP VIEW)

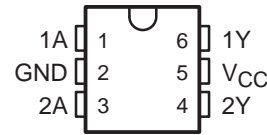

YEP OR YZP PACKAGE  
(BOTTOM VIEW)

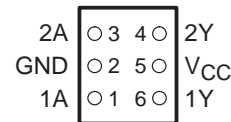

## description/ordering information

This dual inverter is operational at 0.8-V to 2.7-V V<sub>CC</sub>, but is designed specifically for 1.65-V to 1.95-V V<sub>CC</sub> operation.

The SN74AUC2G04 performs the Boolean function  $Y = \bar{A}$ .

NanoStar™ and NanoFree™ package technology is a major breakthrough in IC packaging concepts, using the die as the package.

This device is fully specified for partial-power-down applications using I<sub>off</sub>. The I<sub>off</sub> circuitry disables the outputs, preventing damaging current backflow through the device when it is powered down.

## ORDERING INFORMATION

T <sub>A</sub>	PACKAGE†		ORDERABLE PART NUMBER	TOP-SIDE MARKING‡
–40°C to 85°C	NanoStar™ – WCSP (DSBGA) 0.23-mm Large Bump – YEP	Tape and reel	SN74AUC2G04YEPR	___UC_
	NanoFree™ – WCSP (DSBGA) 0.23-mm Large Bump – YZP (Pb-free)	Tape and reel	SN74AUC2G04YZPR	___UC_
	SOT (SOT-23) – DBV	Tape and reel	SN74AUC2G04DBVR	U04_
	SOT (SC-70) – DCK	Tape and reel	SN74AUC2G04DCKR	UC_

† Package drawings, standard packing quantities, thermal data, symbolization, and PCB design guidelines are available at [www.ti.com/sc/package](http://www.ti.com/sc/package).

‡ DBV/DCK: The actual top-side marking has one additional character that designates the assembly/test site.

YEP/YZP: The actual top-side marking has three preceding characters to denote year, month, and sequence code, and one following character to designate the assembly/test site.



Please be aware that an important notice concerning availability, standard warranty, and use in critical applications of Texas Instruments semiconductor products and disclaimers thereto appears at the end of this data sheet.

NanoStar and NanoFree are trademarks of Texas Instruments.

PRODUCTION DATA information is current as of publication date. Products conform to specifications per the terms of Texas Instruments standard warranty. Production processing does not necessarily include testing of all parameters.



POST OFFICE BOX 655303 • DALLAS, TEXAS 75265

Copyright © 2003, Texas Instruments Incorporated

# SN74AUC2G04 DUAL INVERTER GATE

SCES437A – APRIL 2003 – REVISED JUNE 2003

**FUNCTION TABLE**  
(each inverter)

INPUT A	OUTPUT Y
H	L
L	H

## logic diagram (positive logic)

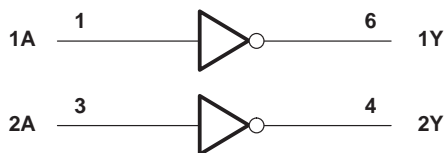

## absolute maximum ratings over operating free-air temperature range (unless otherwise noted)†

Supply voltage range, $V_{CC}$	-0.5 V to 3.6 V
Input voltage range, $V_I$ (see Note 1)	-0.5 V to 3.6 V
Voltage range applied to any output in the high-impedance or power-off state, $V_O$ (see Note 1)	-0.5 V to 3.6 V
Output voltage range, $V_O$ (see Note 1)	-0.5 V to $V_{CC} + 0.5$ V
Input clamp current, $I_{IK}$ ( $V_I < 0$ )	-50 mA
Output clamp current, $I_{OK}$ ( $V_O < 0$ )	-50 mA
Continuous output current, $I_O$	$\pm 20$ mA
Continuous current through $V_{CC}$ or GND	$\pm 100$ mA
Package thermal impedance, $\theta_{JA}$ (see Note 2): DBV package	165°C/W
DCK package	258°C/W
YEP/YZP package	123°C/W
Storage temperature range, $T_{stg}$	-65°C to 150°C

† Stresses beyond those listed under “absolute maximum ratings” may cause permanent damage to the device. These are stress ratings only, and functional operation of the device at these or any other conditions beyond those indicated under “recommended operating conditions” is not implied. Exposure to absolute-maximum-rated conditions for extended periods may affect device reliability.

NOTES: 1. The input negative-voltage and output voltage ratings may be exceeded if the input and output current ratings are observed.  
2. The package thermal impedance is calculated in accordance with JESD 51-7.

recommended operating conditions (see Note 3)

		MIN	MAX	UNIT
V <sub>CC</sub>	Supply voltage	0.8	2.7	V
V <sub>IH</sub>	High-level input voltage	V <sub>CC</sub> = 0.8 V	V <sub>CC</sub>	V
		V <sub>CC</sub> = 1.1 V to 1.95 V	0.65 × V <sub>CC</sub>	
		V <sub>CC</sub> = 2.3 V to 2.7 V	1.7	
V <sub>IL</sub>	Low-level input voltage	V <sub>CC</sub> = 0.8 V	0	V
		V <sub>CC</sub> = 1.1 V to 1.95 V	0.35 × V <sub>CC</sub>	
		V <sub>CC</sub> = 2.3 V to 2.7 V	0.7	
V <sub>I</sub>	Input voltage	0	3.6	V
V <sub>O</sub>	Output voltage	0	V <sub>CC</sub>	V
I <sub>OH</sub>	High-level output current	V <sub>CC</sub> = 0.8 V	-0.7	mA
		V <sub>CC</sub> = 1.1 V	-3	
		V <sub>CC</sub> = 1.4 V	-5	
		V <sub>CC</sub> = 1.65 V	-8	
		V <sub>CC</sub> = 2.3 V	-9	
I <sub>OL</sub>	Low-level output current	V <sub>CC</sub> = 0.8 V	0.7	mA
		V <sub>CC</sub> = 1.1 V	3	
		V <sub>CC</sub> = 1.4 V	5	
		V <sub>CC</sub> = 1.65 V	8	
		V <sub>CC</sub> = 2.3 V	9	
Δt/Δv	Input transition rise or fall rate		20	ns/V
T <sub>A</sub>	Operating free-air temperature	-40	85	°C

NOTE 3: All unused inputs of the device must be held at V<sub>CC</sub> or GND to ensure proper device operation. Refer to the TI application report, *Implications of Slow or Floating CMOS Inputs*, literature number SCBA004.

electrical characteristics over recommended operating free-air temperature range (unless otherwise noted)

PARAMETER	TEST CONDITIONS	V <sub>CC</sub>	MIN	TYP†	MAX	UNIT
V <sub>OH</sub>	I <sub>OH</sub> = -100 μA	0.8 V to 2.7 V	V <sub>CC</sub> -0.1			V
	I <sub>OH</sub> = -0.7 mA	0.8 V		0.55		
	I <sub>OH</sub> = -3 mA	1.1 V	0.8			
	I <sub>OH</sub> = -5 mA	1.4 V	1			
	I <sub>OH</sub> = -8 mA	1.65 V	1.2			
	I <sub>OH</sub> = -9 mA	2.3 V	1.8			
V <sub>OL</sub>	I <sub>OL</sub> = 100 μA	0.8 V to 2.7 V			0.2	V
	I <sub>OL</sub> = 0.7 mA	0.8 V		0.25		
	I <sub>OL</sub> = 3 mA	1.1 V			0.3	
	I <sub>OL</sub> = 5 mA	1.4 V			0.4	
	I <sub>OL</sub> = 8 mA	1.65 V			0.45	
	I <sub>OL</sub> = 9 mA	2.3 V			0.6	
I <sub>I</sub>	A inputs	V <sub>I</sub> = V <sub>CC</sub> or GND	0 to 2.7 V		±5	μA
I <sub>off</sub>		V <sub>I</sub> or V <sub>O</sub> = 2.7 V	0		±10	μA
I <sub>CC</sub>		V <sub>I</sub> = V <sub>CC</sub> or GND, I <sub>O</sub> = 0	0.8 V to 2.7 V		10	μA
C <sub>i</sub>		V <sub>I</sub> = V <sub>CC</sub> or GND	2.5 V		2.1	pF

† All typical values are at T<sub>A</sub> = 25°C.

# SN74AUC2G04

## DUAL INVERTER GATE

SCES437A – APRIL 2003 – REVISED JUNE 2003

switching characteristics over recommended operating free-air temperature range,  $C_L = 15 \text{ pF}$  (unless otherwise noted) (see Figure 1)

PARAMETER	FROM (INPUT)	TO (OUTPUT)	$V_{CC} = 0.8 \text{ V}$	$V_{CC} = 1.2 \text{ V} \pm 0.1 \text{ V}$		$V_{CC} = 1.5 \text{ V} \pm 0.1 \text{ V}$		$V_{CC} = 1.8 \text{ V} \pm 0.15 \text{ V}$			$V_{CC} = 2.5 \text{ V} \pm 0.2 \text{ V}$		UNIT
			TYP	MIN	MAX	MIN	MAX	MIN	TYP	MAX	MIN	MAX	
$t_{pd}$	A	Y	5.4	0.9	3.1	0.7	2	0.6	1	1.7	0.5	1.2	ns

switching characteristics over recommended operating free-air temperature range,  $C_L = 30 \text{ pF}$  (unless otherwise noted) (see Figure 1)

PARAMETER	FROM (INPUT)	TO (OUTPUT)	$V_{CC} = 1.8 \text{ V} \pm 0.15 \text{ V}$			$V_{CC} = 2.5 \text{ V} \pm 0.2 \text{ V}$		UNIT
			MIN	TYP	MAX	MIN	MAX	
$t_{pd}$	A	Y	0.8	1.3	2	0.7	1.5	ns

operating characteristics,  $T_A = 25^\circ\text{C}$

PARAMETER	TEST CONDITIONS	$V_{CC} = 0.8 \text{ V}$	$V_{CC} = 1.2 \text{ V}$	$V_{CC} = 1.5 \text{ V}$	$V_{CC} = 1.8 \text{ V}$	$V_{CC} = 2.5 \text{ V}$	UNIT
		TYP	TYP	TYP	TYP	TYP	
$C_{pd}$ Power dissipation capacitance	$f = 10 \text{ MHz}$	12.5	12.5	12.5	12.5	14	pF



PARAMETER MEASUREMENT INFORMATION

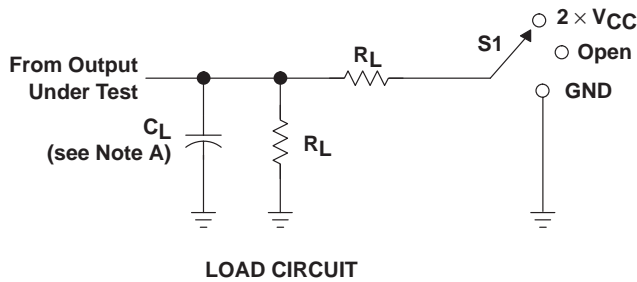

TEST	S1
$t_{PLH}/t_{PHL}$	Open
$t_{PLZ}/t_{PZL}$	$2 \times V_{CC}$
$t_{PHZ}/t_{PZH}$	GND

$V_{CC}$	$C_L$	$R_L$	$V_{\Delta}$
0.8 V	15 pF	2 k $\Omega$	0.1 V
1.2 V $\pm$ 0.1 V	15 pF	2 k $\Omega$	0.1 V
1.5 V $\pm$ 0.1 V	15 pF	2 k $\Omega$	0.1 V
1.8 V $\pm$ 0.15 V	15 pF	2 k $\Omega$	0.15 V
2.5 V $\pm$ 0.2 V	15 pF	2 k $\Omega$	0.15 V
1.8 V $\pm$ 0.15 V	30 pF	1 k $\Omega$	0.15 V
2.5 V $\pm$ 0.2 V	30 pF	500 $\Omega$	0.15 V

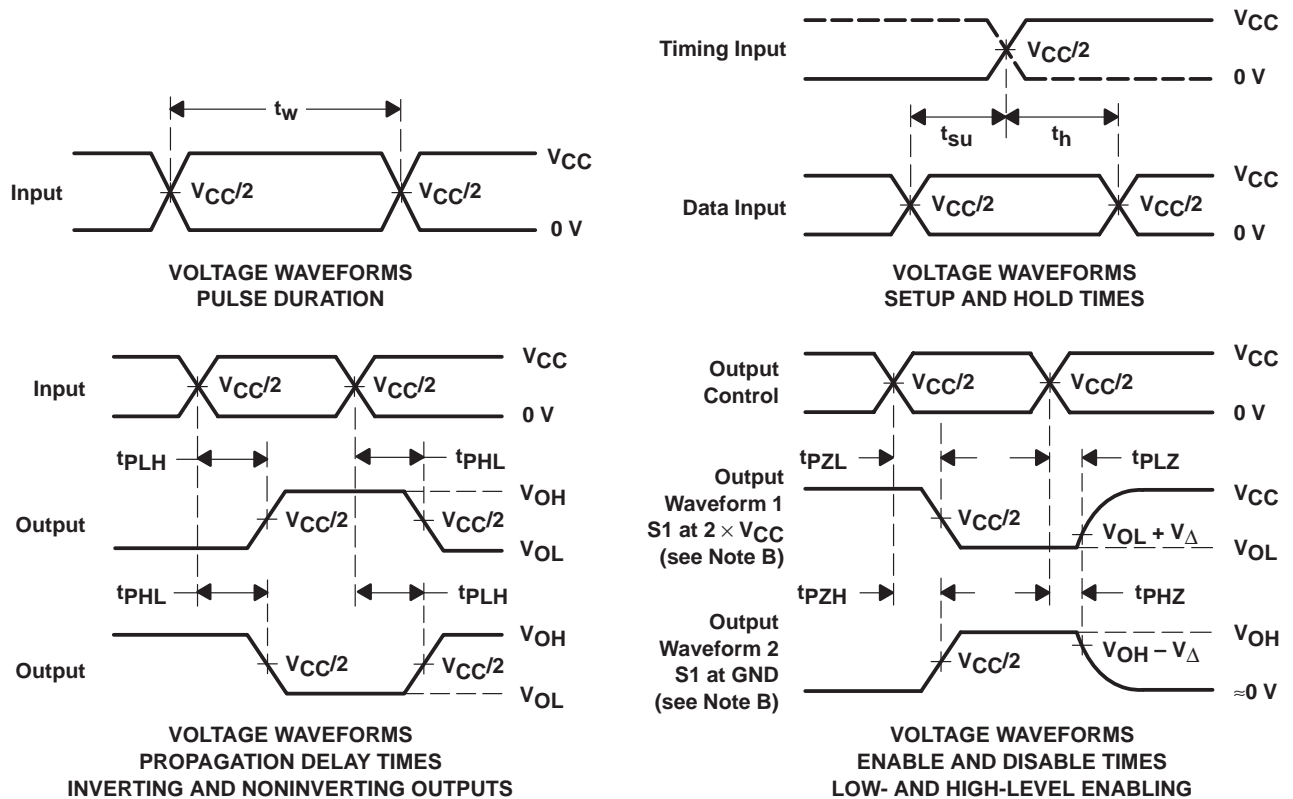

- NOTES:
- A.  $C_L$  includes probe and jig capacitance.
  - B. Waveform 1 is for an output with internal conditions such that the output is low except when disabled by the output control. Waveform 2 is for an output with internal conditions such that the output is high except when disabled by the output control.
  - C. All input pulses are supplied by generators having the following characteristics: PRR  $\leq$  10 MHz,  $Z_O = 50 \Omega$ , slew rate  $\geq$  1 V/ns.
  - D. The outputs are measured one at a time with one transition per measurement.
  - E.  $t_{PLZ}$  and  $t_{PHZ}$  are the same as  $t_{dis}$ .
  - F.  $t_{PZL}$  and  $t_{PZH}$  are the same as  $t_{en}$ .
  - G.  $t_{PLH}$  and  $t_{PHL}$  are the same as  $t_{pd}$ .
  - H. All parameters and waveforms are not applicable to all devices.

Figure 1. Load Circuit and Voltage Waveforms

**PACKAGING INFORMATION**

Orderable Device	Status <sup>(1)</sup>	Package Type	Package Drawing	Pins	Package Qty	Eco Plan <sup>(2)</sup>	Lead/Ball Finish	MSL Peak Temp <sup>(3)</sup>
SN74AUC2G04DBVR	ACTIVE	SOT-23	DBV	6	3000	Green (RoHS & no Sb/Br)	CU NIPDAU	Level-1-260C-UNLIM
SN74AUC2G04DCKR	ACTIVE	SC70	DCK	6	3000	Pb-Free (RoHS)	CU NIPDAU	Level-1-260C-UNLIM
SN74AUC2G04YEPR	ACTIVE	WCSP	YEP	6	3000	None	SNPB	Level-1-260C-UNLIM
SN74AUC2G04YZPR	ACTIVE	WCSP	YZP	6	3000	Pb-Free (RoHS)	SNAGCU	Level-1-260C-UNLIM

<sup>(1)</sup> The marketing status values are defined as follows:

**ACTIVE:** Product device recommended for new designs.

**LIFEBUY:** TI has announced that the device will be discontinued, and a lifetime-buy period is in effect.

**NRND:** Not recommended for new designs. Device is in production to support existing customers, but TI does not recommend using this part in a new design.

**PREVIEW:** Device has been announced but is not in production. Samples may or may not be available.

**OBsolete:** TI has discontinued the production of the device.

<sup>(2)</sup> Eco Plan - May not be currently available - please check <http://www.ti.com/productcontent> for the latest availability information and additional product content details.

**None:** Not yet available Lead (Pb-Free).

**Pb-Free (RoHS):** TI's terms "Lead-Free" or "Pb-Free" mean semiconductor products that are compatible with the current RoHS requirements for all 6 substances, including the requirement that lead not exceed 0.1% by weight in homogeneous materials. Where designed to be soldered at high temperatures, TI Pb-Free products are suitable for use in specified lead-free processes.

**Green (RoHS & no Sb/Br):** TI defines "Green" to mean "Pb-Free" and in addition, uses package materials that do not contain halogens, including bromine (Br) or antimony (Sb) above 0.1% of total product weight.

<sup>(3)</sup> MSL, Peak Temp. -- The Moisture Sensitivity Level rating according to the JEDEC industry standard classifications, and peak solder temperature.

**Important Information and Disclaimer:** The information provided on this page represents TI's knowledge and belief as of the date that it is provided. TI bases its knowledge and belief on information provided by third parties, and makes no representation or warranty as to the accuracy of such information. Efforts are underway to better integrate information from third parties. TI has taken and continues to take reasonable steps to provide representative and accurate information but may not have conducted destructive testing or chemical analysis on incoming materials and chemicals. TI and TI suppliers consider certain information to be proprietary, and thus CAS numbers and other limited information may not be available for release.

In no event shall TI's liability arising out of such information exceed the total purchase price of the TI part(s) at issue in this document sold by TI to Customer on an annual basis.



DCK (R-PDSO-G6)

PLASTIC SMALL-OUTLINE PACKAGE

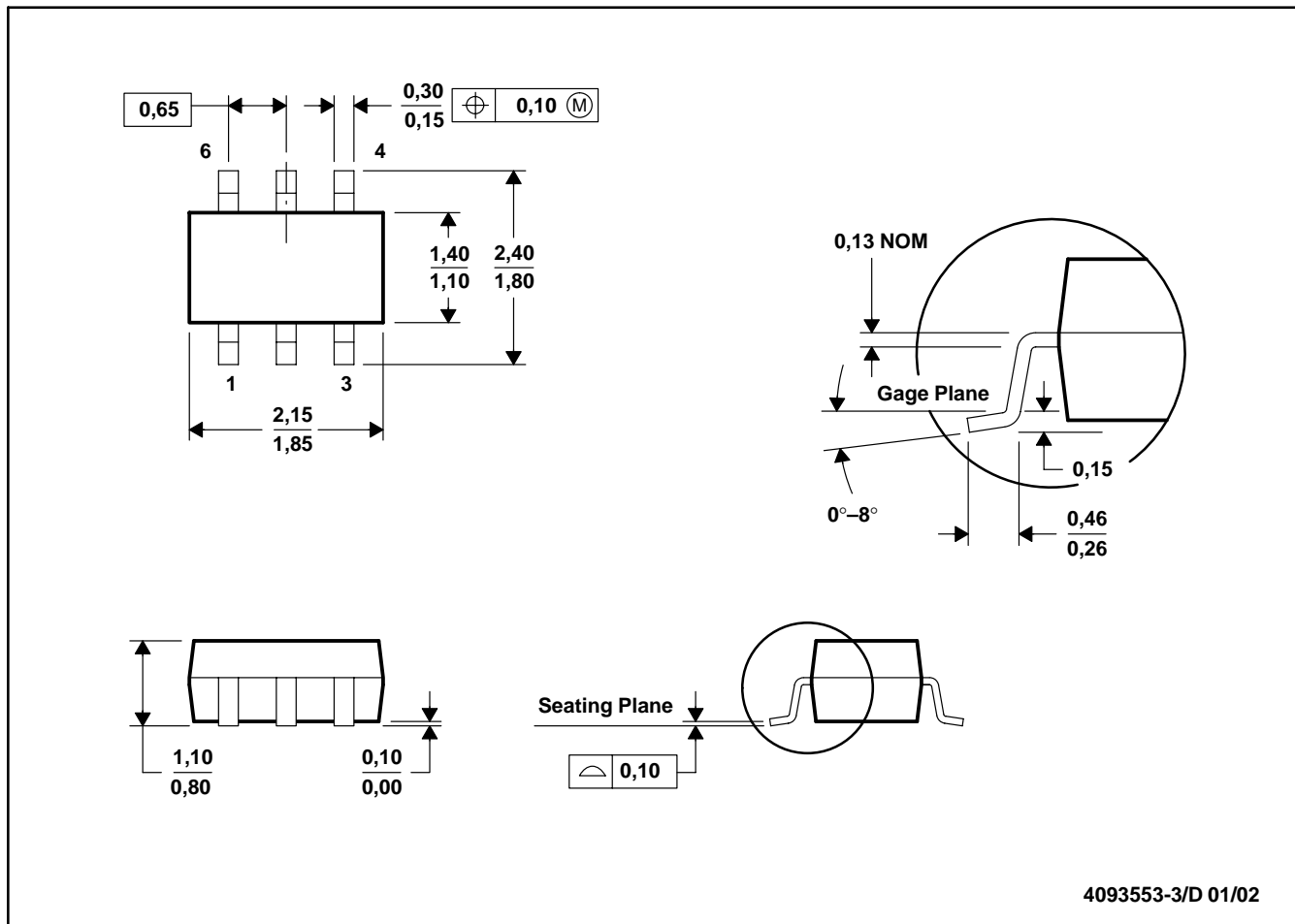

4093553-3/D 01/02

- NOTES: A. All linear dimensions are in millimeters.  
 B. This drawing is subject to change without notice.  
 C. Body dimensions do not include mold flash or protrusion.  
 D. Falls within JEDEC MO-203

YZP (R-XBGA-N6)

DIE-SIZE BALL GRID ARRAY

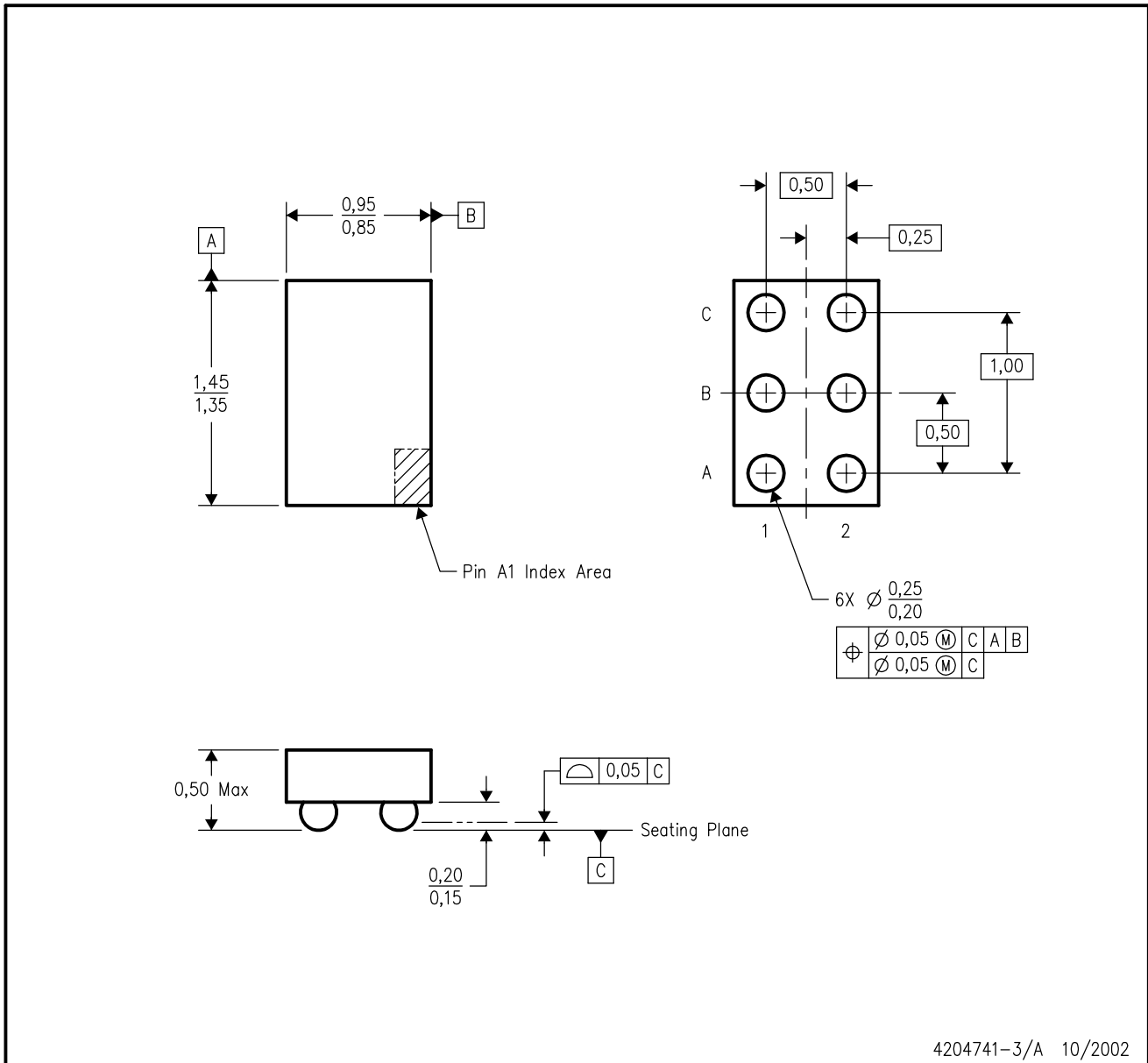

- NOTES:
- A. All linear dimensions are in millimeters.
  - B. This drawing is subject to change without notice.
  - C. NanoFree™ package configuration.
  - D. This package is lead-free. Refer to the 6 YEP package (drawing 4204725) for tin-lead (SnPb).

NanoFree is a trademark of Texas Instruments.

YEP (R-XBGA-N6)

DIE-SIZE BALL GRID ARRAY

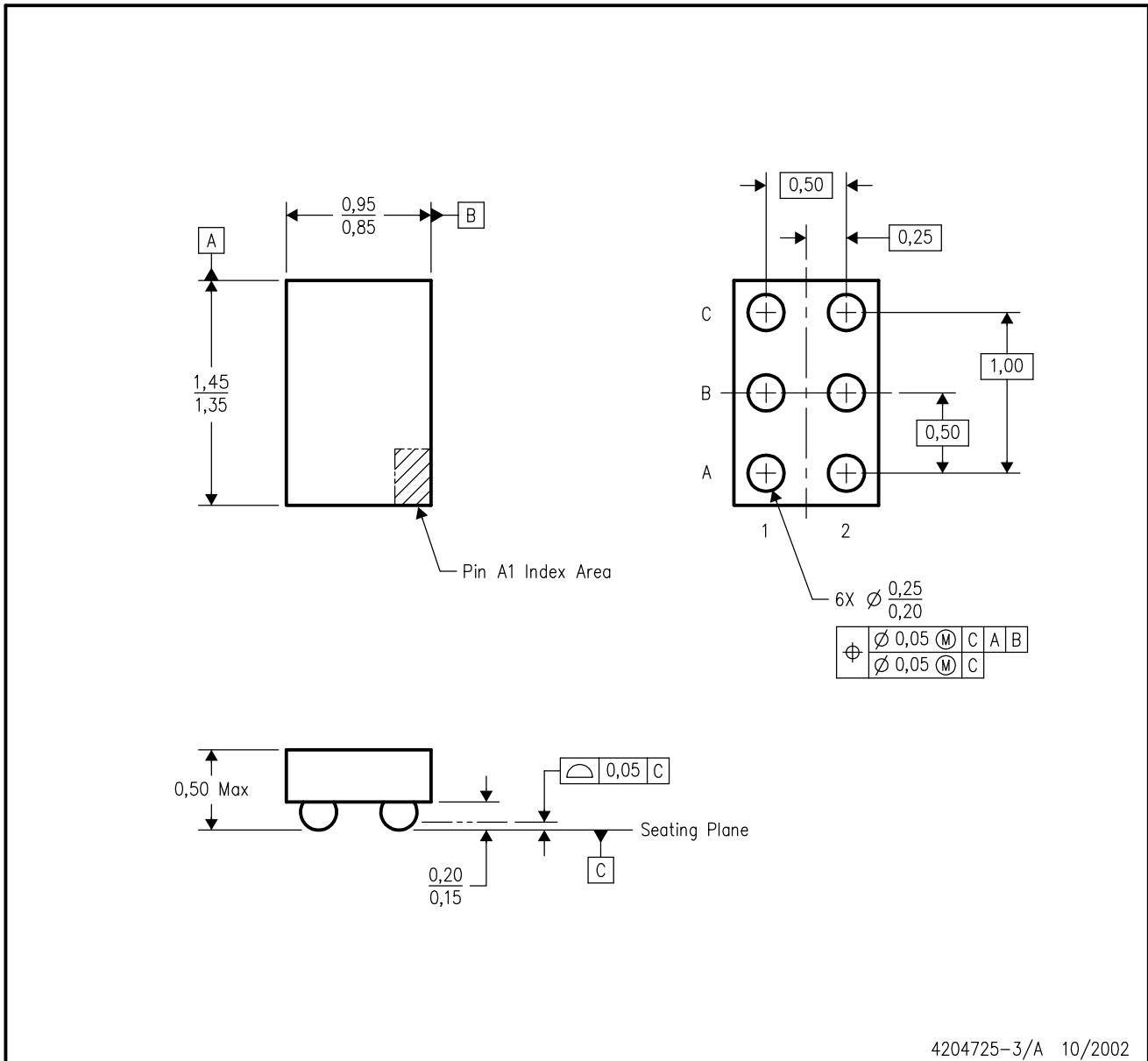

- NOTES:
- A. All linear dimensions are in millimeters.
  - B. This drawing is subject to change without notice.
  - C. NanoStar™ package configuration.
  - D. This package is tin-lead (SnPb). Refer to the 6 YZP package (drawing 4204741) for lead-free.

NanoStar is a trademark of Texas Instruments.

## IMPORTANT NOTICE

Texas Instruments Incorporated and its subsidiaries (TI) reserve the right to make corrections, modifications, enhancements, improvements, and other changes to its products and services at any time and to discontinue any product or service without notice. Customers should obtain the latest relevant information before placing orders and should verify that such information is current and complete. All products are sold subject to TI's terms and conditions of sale supplied at the time of order acknowledgment.

TI warrants performance of its hardware products to the specifications applicable at the time of sale in accordance with TI's standard warranty. Testing and other quality control techniques are used to the extent TI deems necessary to support this warranty. Except where mandated by government requirements, testing of all parameters of each product is not necessarily performed.

TI assumes no liability for applications assistance or customer product design. Customers are responsible for their products and applications using TI components. To minimize the risks associated with customer products and applications, customers should provide adequate design and operating safeguards.

TI does not warrant or represent that any license, either express or implied, is granted under any TI patent right, copyright, mask work right, or other TI intellectual property right relating to any combination, machine, or process in which TI products or services are used. Information published by TI regarding third-party products or services does not constitute a license from TI to use such products or services or a warranty or endorsement thereof. Use of such information may require a license from a third party under the patents or other intellectual property of the third party, or a license from TI under the patents or other intellectual property of TI.

Reproduction of information in TI data books or data sheets is permissible only if reproduction is without alteration and is accompanied by all associated warranties, conditions, limitations, and notices. Reproduction of this information with alteration is an unfair and deceptive business practice. TI is not responsible or liable for such altered documentation.

Resale of TI products or services with statements different from or beyond the parameters stated by TI for that product or service voids all express and any implied warranties for the associated TI product or service and is an unfair and deceptive business practice. TI is not responsible or liable for any such statements.

Following are URLs where you can obtain information on other Texas Instruments products and application solutions:

<b>Products</b>		<b>Applications</b>	
Amplifiers	<a href="http://amplifier.ti.com">amplifier.ti.com</a>	Audio	<a href="http://www.ti.com/audio">www.ti.com/audio</a>
Data Converters	<a href="http://dataconverter.ti.com">dataconverter.ti.com</a>	Automotive	<a href="http://www.ti.com/automotive">www.ti.com/automotive</a>
DSP	<a href="http://dsp.ti.com">dsp.ti.com</a>	Broadband	<a href="http://www.ti.com/broadband">www.ti.com/broadband</a>
Interface	<a href="http://interface.ti.com">interface.ti.com</a>	Digital Control	<a href="http://www.ti.com/digitalcontrol">www.ti.com/digitalcontrol</a>
Logic	<a href="http://logic.ti.com">logic.ti.com</a>	Military	<a href="http://www.ti.com/military">www.ti.com/military</a>
Power Mgmt	<a href="http://power.ti.com">power.ti.com</a>	Optical Networking	<a href="http://www.ti.com/opticalnetwork">www.ti.com/opticalnetwork</a>
Microcontrollers	<a href="http://microcontroller.ti.com">microcontroller.ti.com</a>	Security	<a href="http://www.ti.com/security">www.ti.com/security</a>
		Telephony	<a href="http://www.ti.com/telephony">www.ti.com/telephony</a>
		Video & Imaging	<a href="http://www.ti.com/video">www.ti.com/video</a>
		Wireless	<a href="http://www.ti.com/wireless">www.ti.com/wireless</a>

Mailing Address: Texas Instruments  
Post Office Box 655303 Dallas, Texas 75265