

8961726 TEXAS INSTR (OPTO)

62C 36692 D

T-25-13

TIC106A, TIC106B, TIC106C, TIC106D,
TIC106E, TIC106F, TIC106M
P-N-P-N SILICON REVERSE-BLOCKING TRIODE THYRISTORS
APRIL 1971 - REVISED OCTOBER 1984

- Silicon Controlled Rectifiers
- 50 V to 600 V
- 5 A DC
- 30 A Surge Current
- MAX IGT of 200 A

device schematic

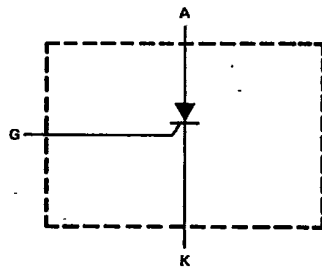

TO-220AB PACKAGE

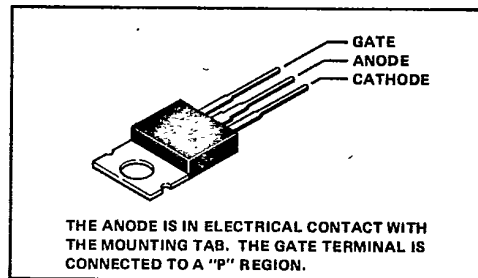

absolute maximum ratings at 25°C case temperature (unless otherwise noted)

	TIC106F	TIC106A	TIC106B	TIC106C
Repetitive peak off-state voltage, V_{DRM} (see Note 1)	50 V	100 V	200 V	300 V
Repetitive peak reverse voltage, V_{RRM}	50 V	100 V	200 V	300 V
Continuous on-state current at (or below) 80°C case temperature (see Note 2)	5 A			
Average on-state current (180° conduction angle) at (or below) 80°C case temperature (see Note 3)	3.2 A			
Surge on-state current (see Note 4)	30 A			
Peak positive gate current (pulse duration $\leq 300 \mu s$)	0.2 A			
Peak gate power dissipation (pulse duration $\leq 300 \mu s$)	1.3 W			
Average gate power dissipation (see Note 5)	0.3 W			
Operating case temperature range	-40°C to 110°C			
Storage temperature range	-40°C to 125°C			
Lead temperature 1,6 mm (1/16 inch) from case for 10 seconds	230°C			

- NOTES: 1. These values apply when the gate-cathode resistance $R_{GK} = 1 \text{ k}\Omega$.
 2. These values apply for continuous d-c operation with resistive load. Above 80°C derate according to Figure 3.
 3. This value may be applied continuously under single-phase 50-Hz half-sine-wave operation with resistive load. Above 80°C derate according to Figure 3.
 4. This value applies for one 50-Hz half-sine-wave when the device is operating at (or below) rated values of peak reverse voltage and on-state current. Surge may be repeated after the device has returned to original thermal equilibrium.
 5. This value applies for a maximum averaging time of 20 ms.

4

TIC Devices

8961726 TEXAS INSTR (OPTO)

62C 36693 D

7-25-13

TIC106A, TIC106B, TIC106C, TIC106D,
TIC106E, TIC106F, TIC106M
P-N-P-N SILICON REVERSE-BLOCKING TRIODE THYRISTORS

absolute maximum ratings at 25°C case temperature (unless otherwise noted)

	TIC106D	TIC106E	TIC106M
Repetitive peak off-state voltage, V_{DRM} (see Note 1)	400 V	500 V	600 V
Repetitive peak reverse voltage, V_{RRM}	400 V	500 V	600 V
Continuous on-state current at (or below) 80°C case temperature (see Note 2)	5 A		
Average on-state current (180° conduction angle) at (or below) 80°C case temperature (see Note 3)	3.2 A		
Surge on-state current (see Note 4)	30 A		
Peak positive gate current (pulse duration $\leq 300 \mu s$)	0.2 A		
Peak gate power dissipation (pulse duration $\leq 300 \mu s$)	1.3 W		
Average gate power dissipation (see Note 5)	0.3 W		
Operating case temperature range	-40°C to 110°C		
Storage temperature range	-40°C to 125°C		
Lead temperature 1,6 mm (1/16 inch) from case for 10 seconds	230°C		

- NOTES: 1. These values apply when the gate-cathode resistance $R_{GK} = 1 k\Omega$.
 2. These values apply for continuous d-c operation with resistive load. Above 80°C derate according to Figure 3.
 3. This value may be applied continuously under single-phase 50-Hz half-sine-wave operation with resistive load. Above 80°C derate according to Figure 3.
 4. This value applies for one 50-Hz half-sine-wave when the device is operating at (or below) rated values of peak reverse voltage and on-state current. Surge may be repeated after the device has returned to original thermal equilibrium.
 5. This value applies for a maximum averaging time of 20 ms.

electrical characteristics at 25°C case temperature (unless otherwise noted)

PARAMETER	TEST CONDITIONS	MIN	TYP	MAX	UNIT	
I_{DRM} Repetitive Peak Off-State Current	$V_D = \text{Rated } V_{DRM}, R_{GK} = 1 k\Omega, T_C = 110^\circ C$		400		μA	
I_{RRM} Repetitive Peak Reverse Current	$V_R = \text{Rated } V_{RRM}, I_G = 0, T_C = 110^\circ C$			1	mA	
I_{GT} Gate Trigger Current	$V_{AA} = 6 V, R_L = 100 \Omega, t_{w(g)} \geq 20 \mu s, T_C = -40^\circ C$		60	200	μA	
V_{GT} Gate Trigger Voltage	$V_{AA} = 6 V, R_L = 100 \Omega, R_{GK} = 1 k\Omega, t_{w(g)} \geq 20 \mu s, T_C = -40^\circ C$		0.4	0.6	1	V
	$V_{AA} = 6 V, R_L = 100 \Omega, R_{GK} = 1 k\Omega, t_{w(g)} \geq 20 \mu s, T_C = -110^\circ C$		0.2			
	$V_{AA} = 6 V, R_{GK} = 1 k\Omega, \text{Initiating } I_T = 10 \text{ mA}$				5	mA
I_H Holding Current	$V_{AA} = 6 V, R_{GK} = 1 k\Omega, \text{Initiating } I_T = 10 \text{ mA}, T_C = -40^\circ C$				8	mA
	$I_{TM} = 5 A, \text{See Note 6}$			1.7	V	
V_{TM} Peak On-State Voltage	$I_{TM} = 5 A, \text{See Note 6}$			1.7	V	
dv/dt Critical Rate of Rise of Off-State Voltage	$V_D = \text{Rated } V_D, R_{GK} = 1 k\Omega, T_C = 110^\circ C$		10		V/ μs	

NOTE 6: These parameters must be measured using pulse techniques, $t_w = 300 \mu s$, duty cycle $\leq 2 \%$. Voltage-sensing contacts, separate from the current-carrying contacts, are located within 3,2 mm (1/8 inch) from the device body.

thermal characteristics

PARAMETER	MIN	TYP	MAX	UNIT
$R_{\theta JC}$			3.5	$^\circ C/W$
$R_{\theta JA}$			62.5	$^\circ C/W$

4
TIC Devices

8961726 TEXAS INSTR (OPT0)

62C 36694 D

T-25-13

TIC106A, TIC106B, TIC106C, TIC106D,
TIC106E, TIC106F, TIC106M

P-N-P-N SILICON REVERSE-BLOCKING TRIODE THYRISTORS

resistive-load switching characteristics at 25°C case temperature

PARAMETER	TEST CONDITIONS			MIN	TYP	MAX	UNIT
t_{gt} Gate-Controlled Turn-On Time	$V_{AA} = 30\text{ V}$,	$R_L = 6\ \Omega$,	$R_{GK(off)} = 5\text{ k}\Omega$,		1.75		μs
	$V_{in} = 50\text{ V}$,	See Figure 1					
t_q Circuit-Commutated Turn-Off Time	$V_{AA} = 30\text{ V}$,	$R_L = 6\ \Omega$,	$I_{RM} \approx 8\text{ A}$,		7.7		
	See Figure 2						

PARAMETER MEASUREMENT INFORMATION

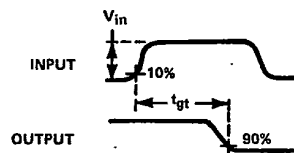

VOLTAGE WAVEFORMS

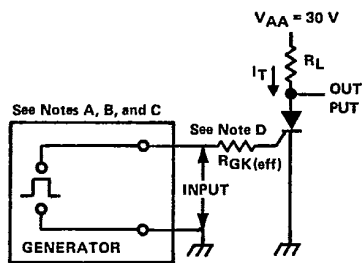

TEST CIRCUIT

FIGURE 1. GATE-CONTROLLED TURN-ON TIME

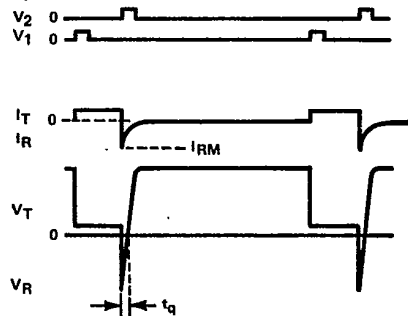

WAVEFORMS

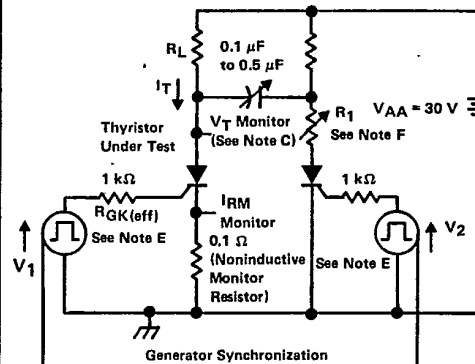

TEST CIRCUIT

FIGURE 2. CIRCUIT-COMMUTATED TURN-OFF TIME

- NOTES:
- A. V_{in} is measured with gate and cathode terminals open.
 - B. The input waveform of Figure 1 has the following characteristics: $t_r \leq 40\text{ ns}$, $t_w \geq 20\ \mu\text{s}$.
 - C. Waveforms are monitored on an oscilloscope with the following characteristics: $t_r \leq 14\text{ ns}$, $R_{in} \geq 10\text{ M}\Omega$, $C_{in} \leq 12\text{ pF}$.
 - D. $R_{GK(off)}$ includes the total resistance of the generator and the external resistor.
 - E. Pulse generators for V_1 and V_2 are synchronized to provide an anode current waveform with the following characteristics: $t_w = 50\text{ to }300\ \mu\text{s}$, duty cycle = 1%. The pulse widths of V_1 and V_2 are $\geq 10\ \mu\text{s}$.
 - F. Resistor R_1 is adjusted for $I_{RM} \approx 8\text{ A}$.

4
TIC Devices

8961726 TEXAS INSTR (OPTO)

62C 36696 D

TIC106A, TIC106B, TIC106C, TIC106D,
TIC106E, TIC106F, TIC106M
P-N-P-N SILICON REVERSE-BLOCKING TRIODE THYRISTORS

TYPICAL CHARACTERISTICS

T-25-13

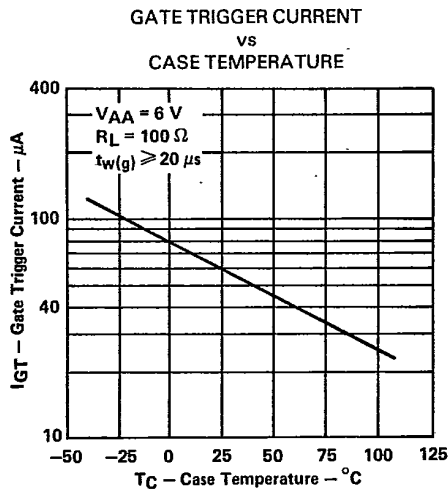

FIGURE 7

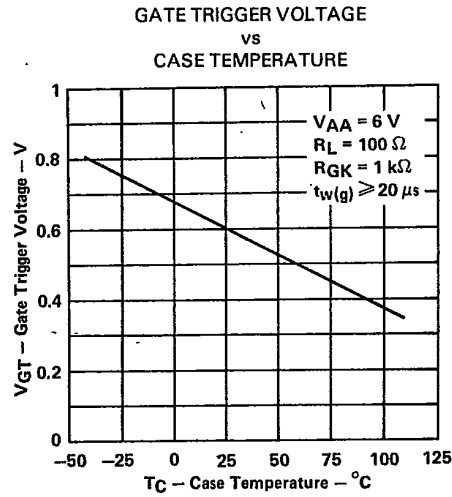

FIGURE 8

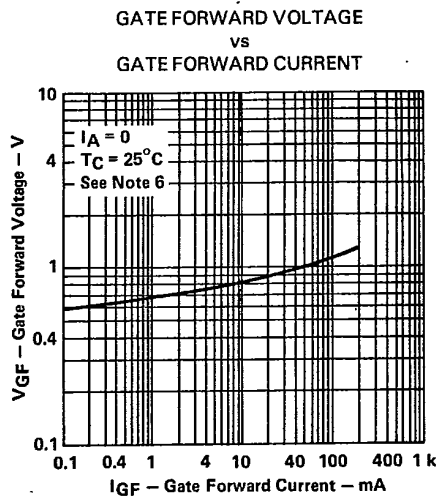

FIGURE 9

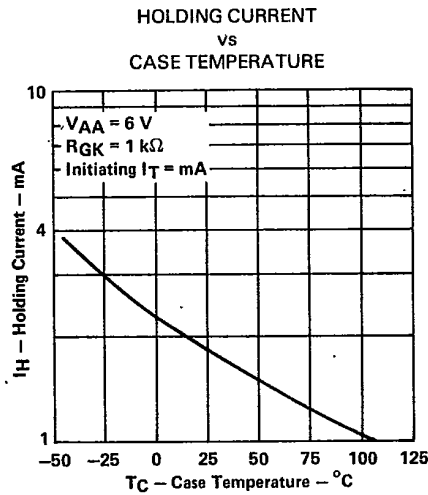

FIGURE 10

NOTE 6: These parameters must be measured using pulse techniques, $t_w = 300 \mu s$, duty cycle $\leq 2\%$. Voltage-sensing contacts, separate from the current-carrying contacts, are located within 3.2 mm (1/8 inch) from the device body.

4
TIC Devices

8961726 TEXAS INSTR (OPT0)

62C 36697 D

TIC106A, TIC106B, TIC106C, TIC106D,
TIC106E, TIC106F, TIC106M
P-N-P-N SILICON REVERSE-BLOCKING TRIODE THYRISTORS

T-25-13

TYPICAL CHARACTERISTICS

PEAK ON-STATE VOLTAGE
VS
PEAK ON-STATE CURRENT

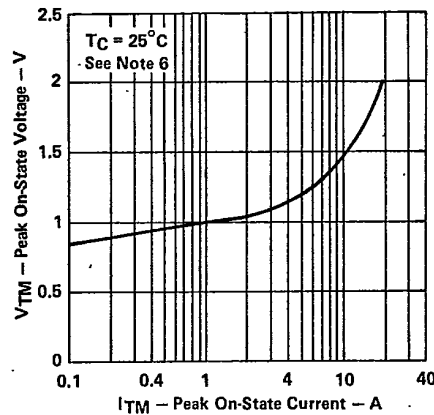

FIGURE 11

4

TIC Devices

GATE-CONTROLLED TURN-ON TIME
VS
GATE CURRENT

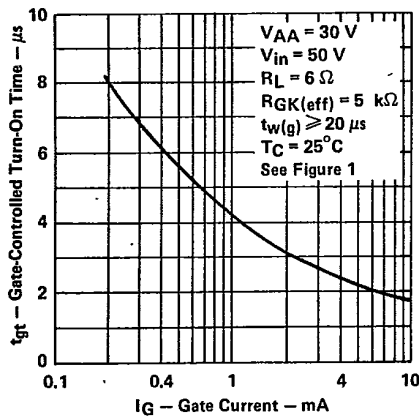

FIGURE 12

CIRCUIT-COMMUTATED TURN-OFF TIME
VS
CASE TEMPERATURE

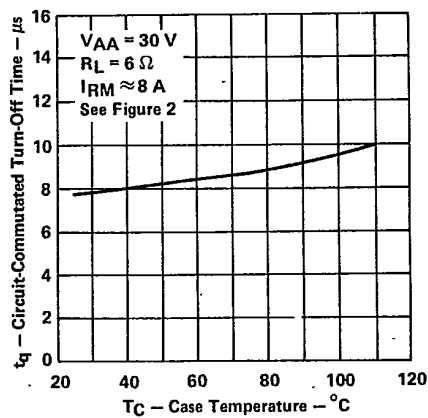

FIGURE 13

NOTE 6: These parameters must be measured using pulse techniques, $t_w = 300 \mu s$, duty cycle $\leq 2\%$. Voltage-sensing contacts, separate from the current-carrying contacts, are located within 3.2 mm (1/8 inch) from the device body.