

# TLC225x-EP, TLC225xA-EP Advanced LinCMOS™ RAIL-TO-RAIL VERY LOW-POWER OPERATIONAL AMPLIFIERS

SGLS216 – NOVEMBER 2003

- **Controlled Baseline**
  - One Assembly/Test Site, One Fabrication Site
- **Extended Temperature Performance of –40°C to 125°C**
- **Enhanced Diminishing Manufacturing Sources (DMS) Support**
- **Enhanced Product-Change Notification**
- **Qualification Pedigree†**
- **ESD Protection Exceeds 2000 V Per MIL-STD-883, Method 3015; Exceeds 150 V (TLC2252/52A) and 100 V (TLC2254/54A) Using Machine Model (C = 200 pF, R = 0)**
- **Output Swing Includes Both Supply Rails**
- **Low Noise . . . 19 nV/√Hz Typ at f = 1 kHz**
- **Low Input Bias Current . . . 1 pA Typ**
- **Fully Specified for Both Single-Supply and Split-Supply Operation**
- **Very Low Power . . . 35 μA Per Channel Typ**
- **Common-Mode Input Voltage Range Includes Negative Rail**
- **Low Input Offset Voltage**  
850 μV Max at T<sub>A</sub> = 25°C (TLC225xA)
- **Macromodel Included**
- **Performance Upgrades for the TS27L2/L4 and TLC27L2/L4**

† Component qualification in accordance with JEDEC and industry standards to ensure reliable operation over an extended temperature range. This includes, but is not limited to, Highly Accelerated Stress Test (HAST) or biased 85/85, temperature cycle, autoclave or unbiased HAST, electromigration, bond intermetallic life, and mold compound life. Such qualification testing should not be viewed as justifying use of this component beyond specified performance and environmental limits.

## description

The TLC2252 and TLC2254 are dual and quadruple operational amplifiers from Texas Instruments. Both devices exhibit rail-to-rail output performance for increased dynamic range in single- or split-supply applications. The TLC225x family consumes only 35 μA of supply current per channel. This micropower operation makes them good choices for battery-powered applications. The noise performance has been dramatically improved over previous generations of CMOS amplifiers. Looking at Figure 1, the TLC225x has a noise level of 19 nV/√Hz at 1kHz; four times lower than competitive micropower solutions.

The TLC225x amplifiers, exhibiting high input impedance and low noise, are excellent for small-signal conditioning for high-impedance sources, such as piezoelectric transducers. Because of the micropower dissipation levels, these devices work well in hand-held monitoring and remote-sensing applications. In addition, the rail-to-rail output feature with single or split supplies makes this family a great choice when interfacing with analog-to-digital converters (ADCs). For precision applications, the TLC225xA family is available and has a maximum input offset voltage of 850 μV. This family is fully characterized at 5 V and ±5 V.

EQUIVALENT INPUT NOISE VOLTAGE  
vs  
FREQUENCY

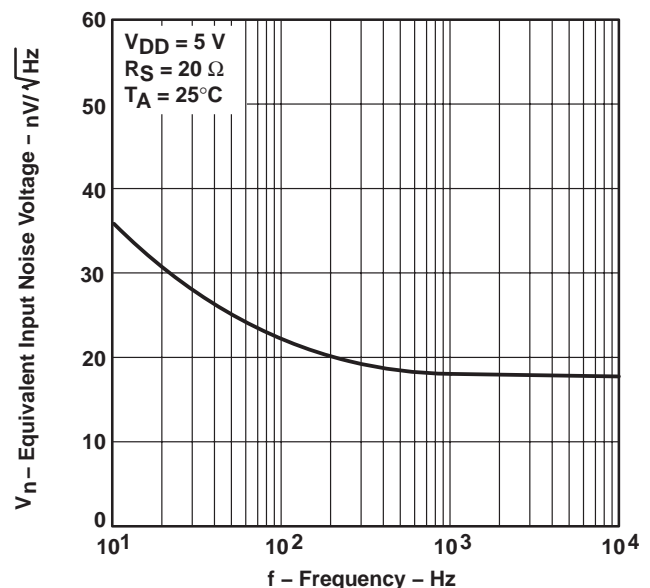


Figure 1



Please be aware that an important notice concerning availability, standard warranty, and use in critical applications of Texas Instruments semiconductor products and disclaimers thereto appears at the end of this data sheet.

Advanced LinCMOS is a trademark of Texas Instruments.

PRODUCTION DATA information is current as of publication date. Products conform to specifications per the terms of Texas Instruments standard warranty. Production processing does not necessarily include testing of all parameters.



POST OFFICE BOX 655303 • DALLAS, TEXAS 75265

Copyright © 2003 Texas Instruments Incorporated

# TLC225x-EP, TLC225xA-EP

## Advanced LinCMOS™ RAIL-TO-RAIL

### VERY LOW-POWER OPERATIONAL AMPLIFIERS

SGLS216 – NOVEMBER 2003

#### description/ordering information (continued)

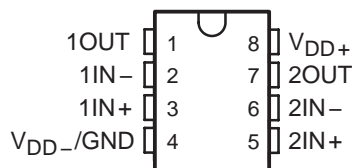
The TLC2252/4 also makes great upgrades to the TLC27L2/L4 or TS27L2/L4 in standard designs. They offer increased output dynamic range, lower noise voltage, and lower input offset voltage. This enhanced feature set allows them to be used in a wider range of applications. For applications that require higher output drive and wider input voltage ranges, see the TLV2432 and TLV2442 devices. If the design requires single amplifiers, please see the TLV2211/21/31 family. These devices are single rail-to-rail operational amplifiers in the SOT-23 package. Their small size and low power consumption, make them ideal for high density, battery-powered equipment.

#### ORDERING INFORMATION

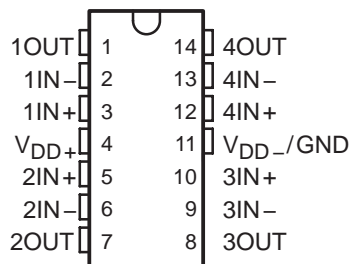
TA	V <sub>IO</sub> max AT 25°C	PACKAGE†		ORDERABLE PART NUMBER	TOP-SIDE MARKING
-40°C to 125°C	850 μV	SOIC (D)	Tape and reel	TLC2252AQDREP	2252AE
	1550 μV	SOIC (D)	Tape and reel	TLC2252QDREP	2252EP
	850 μV	SOIC (D)	Tape and reel	TLC2254AQDREP	TLC2254AEP
	1550 μV	SOIC (D)	Tape and reel	TLC2254QDREP	TLC2254EP

† Package drawings, standard packing quantities, thermal data, symbolization, and PCB design guidelines are available at [www.ti.com/sc/package](http://www.ti.com/sc/package).

TLC2252, TLC2252A  
D PACKAGE  
(TOP VIEW)



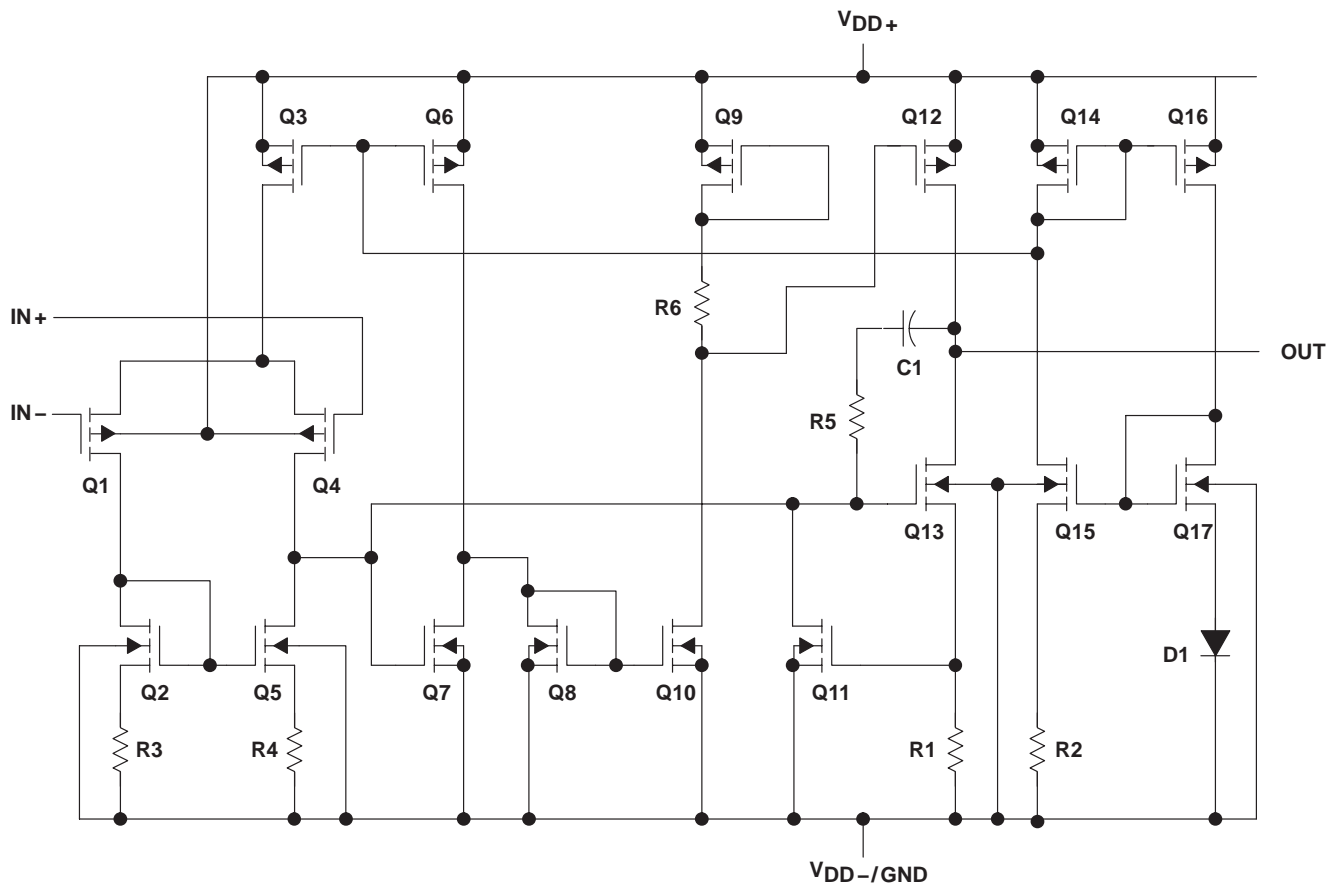
TLC2254, TLC2254A  
D PACKAGE  
(TOP VIEW)



**TLC225x-EP, TLC225xA-EP**  
**Advanced LinCMOS™ RAIL-TO-RAIL**  
**VERY LOW-POWER OPERATIONAL AMPLIFIERS**

SGLS216 – NOVEMBER 2003

equivalent schematic (each amplifier)



ACTUAL DEVICE COMPONENT COUNT†		
COMPONENT	TLC2252	TLC2254
Transistors	38	76
Resistors	30	56
Diodes	9	18
Capacitors	3	6

† Includes both amplifiers and all ESD, bias, and trim circuitry

**TLC225x-EP, TLC225xA-EP**  
**Advanced LinCMOS™ RAIL-TO-RAIL**  
**VERY LOW-POWER OPERATIONAL AMPLIFIERS**

SGLS216 – NOVEMBER 2003

**absolute maximum ratings over operating free-air temperature range (unless otherwise noted)†**

Supply voltage, $V_{DD+}$ (see Note 1)	8 V
Supply voltage, $V_{DD-}$ (see Note 1)	-8 V
Differential input voltage, $V_{ID}$ (see Note 2)	$\pm 16$ V
Input voltage, $V_I$ (any input, see Note 1)	$\pm 8$ V
Input current, $I_I$ (each input)	$\pm 5$ mA
Output current, $I_O$	$\pm 50$ mA
Total current into $V_{DD+}$	$\pm 50$ mA
Total current out of $V_{DD-}$	$\pm 50$ mA
Duration of short-circuit current at (or below) 25°C (see Note 3)	unlimited
Continuous total dissipation	See Dissipation Rating Table
Operating free-air temperature range, $T_A$ : Q suffix	-40°C to 125°C
Storage temperature range, $T_{stg}$	-65°C to 150°C
Lead temperature 1,6 mm (1/16 inch) from case for 10 seconds	260°C

† Stresses beyond those listed under “absolute maximum ratings” may cause permanent damage to the device. These are stress ratings only, and functional operation of the device at these or any other conditions beyond those indicated under “recommended operating conditions” is not implied. Exposure to absolute-maximum-rated conditions for extended periods may affect device reliability.

- NOTES: 1. All voltage values, except differential voltages, are with respect to the midpoint between  $V_{DD+}$  and  $V_{DD-}$ .  
 2. Differential voltages are at  $IN+$  with respect to  $IN-$ . Excessive current flows when input is brought below  $V_{DD-} - 0.3$  V.  
 3. The output may be shorted to either supply. Temperature and/or supply voltages must be limited to ensure that the maximum dissipation rating is not exceeded.

**DISSIPATION RATING TABLE**

PACKAGE	$T_A \leq 25^\circ\text{C}$ POWER RATING	DERATING FACTOR ABOVE $T_A = 25^\circ\text{C}$	$T_A = 70^\circ\text{C}$ POWER RATING	$T_A = 85^\circ\text{C}$ POWER RATING	$T_A = 125^\circ\text{C}$ POWER RATING
D-8	724 mW	5.8 mW/°C	464 mW	377 mW	144 mW
D-14	950 mW	7.6 mW/°C	608 mW	450 mW	190 mW

**recommended operating conditions**

	MIN	MAX	UNIT
Supply voltage, $V_{DD\pm}$	$\pm 2.2$	$\pm 8$	V
Input voltage range, $V_I$	$V_{DD-}$	$V_{DD+} - 1.5$	V
Common-mode input voltage, $V_{IC}$	$V_{DD-}$	$V_{DD+} - 1.5$	V
Operating free-air temperature, $T_A$	-40	125	°C

‡ Referenced to 2.5 V



**TLC225x-EP, TLC225xA-EP**  
**Advanced LinCMOS™ RAIL-TO-RAIL**  
**VERY LOW-POWER OPERATIONAL AMPLIFIERS**

SGLS216 – NOVEMBER 2003

**electrical characteristics at specified free-air temperature,  $V_{DD} = 5\text{ V}$  (unless otherwise noted)**

PARAMETER	TEST CONDITIONS	$T_A$ †	TLC2252-EP			TLC2252A-EP			UNIT	
			MIN	TYP	MAX	MIN	TYP	MAX		
$V_{IO}$ Input offset voltage		25°C	200	1500		200	850	$\mu\text{V}$		
		Full range		1750		1000				
$\alpha_{VIO}$ Temperature coefficient of input offset voltage		25°C to 125°C	0.5			0.5			$\mu\text{V}/^\circ\text{C}$	
Input offset voltage long-term drift (see Note 4)	$V_{DD\pm} = \pm 2.5\text{ V}$ , $V_O = 0$ , $V_{IC} = 0$ , $R_S = 50\ \Omega$	25°C	0.003			0.003			$\mu\text{V}/\text{mo}$	
$I_{IO}$ Input offset current		25°C	0.5	60		0.5	60	$\text{pA}$		
$I_{IB}$ Input bias current		Full range	1000			1000				
		25°C	1	60		1	60	$\text{pA}$		
$V_{ICR}$ Common-mode input voltage range	$R_S = 50\ \Omega$ , $ V_{IO}  \leq 5\text{ mV}$	25°C	0 to 4	-0.3 to 4.2		0 to 4	-0.3 to 4.2		$\text{V}$	
		Full range	0 to 3.5		0 to 3.5					
$V_{OH}$ High-level output voltage	$I_{OH} = -20\ \mu\text{A}$	25°C	4.98			4.98			$\text{V}$	
	$I_{OH} = -75\ \mu\text{A}$	25°C	4.9	4.94		4.9	4.94			
	Full range	4.8			4.8					
$V_{OL}$ Low-level output voltage	$V_{IC} = 2.5\text{ V}$ , $I_{OL} = 50\ \mu\text{A}$	25°C	0.01			0.01			$\text{V}$	
	$V_{IC} = 2.5\text{ V}$ , $I_{OL} = 500\ \mu\text{A}$	25°C	0.09	0.15		0.09	0.15			
		Full range	0.15			0.15				
	$V_{IC} = 2.5\text{ V}$ , $I_{OL} = 4\text{ mA}$	25°C	0.8	1		0.7	1			
Full range		1.2			1.2					
$A_{VD}$ Large-signal differential voltage amplification	$V_{IC} = 2.5\text{ V}$ , $V_O = 1\text{ V to }4\text{ V}$	$R_L = 100\text{ k}\Omega^\ddagger$	25°C	100	350		100	350	$\text{V}/\text{mV}$	
		$R_L = 1\text{ M}\Omega^\ddagger$	Full range	10			10			
			25°C	1700			1700			
$r_{id}$ Differential input resistance		25°C	$10^{12}$			$10^{12}$			$\Omega$	
$r_{ic}$ Common-mode input resistance		25°C	$10^{12}$			$10^{12}$			$\Omega$	
$c_{ic}$ Common-mode input capacitance	$f = 10\text{ kHz}$ , $f = 10\text{ kHz}$ ,	25°C	8			8			$\text{pF}$	
$z_o$ Closed-loop output impedance	$f = 25\text{ kHz}$ , $A_V = 10$	25°C	200			200			$\Omega$	
CMRR Common-mode rejection ratio	$V_{IC} = 0\text{ to }2.7\text{ V}$ , $V_O = 2.5\text{ V}$ , $R_S = 50\ \Omega$	25°C	70	83		70	83	$\text{dB}$		
		Full range	70			70				
$k_{SVR}$ Supply-voltage rejection ratio ( $\Delta V_{DD}/\Delta V_{IO}$ )	$V_{DD} = 4.4\text{ V to }16\text{ V}$ , $V_{IC} = V_{DD}/2$ , No load	25°C	80	95		80	95	$\text{dB}$		
		Full range	80			80				
$I_{DD}$ Supply current	$V_O = 2.5\text{ V}$ , No load	25°C	70	125		70	125	$\mu\text{A}$		
		Full range	150			150				

† Full range is  $-40^\circ\text{C}$  to  $125^\circ\text{C}$  for Q suffix.

‡ Referenced to 2.5 V

NOTE 4: Typical values are based on the input offset voltage shift observed through 500 hours of operating life test at  $T_A = 150^\circ\text{C}$  extrapolated to  $T_A = 25^\circ\text{C}$  using the Arrhenius equation and assuming an activation energy of 0.96 eV.



**TLC225x-EP, TLC225xA-EP**  
**Advanced LinCMOS™ RAIL-TO-RAIL**  
**VERY LOW-POWER OPERATIONAL AMPLIFIERS**

SGLS216 – NOVEMBER 2003

operating characteristics at specified free-air temperature,  $V_{DD} = 5\text{ V}$

PARAMETER	TEST CONDITIONS	$T_A$ †	TLC2252-EP			TLC2252A-EP			UNIT
			MIN	TYP	MAX	MIN	TYP	MAX	
SR	Slew rate at unity gain $V_O = 0.5\text{ V to }3.5\text{ V}$ , $R_L = 100\text{ k}\Omega$ ‡, $C_L = 100\text{ pF}$ ‡	25°C	0.07	0.12		0.07	0.12		V/ $\mu$ s
		Full range	0.05			0.05			
$V_n$	Equivalent input noise voltage $f = 10\text{ Hz}$ $f = 1\text{ kHz}$	25°C	36			36			nV/ $\sqrt{\text{Hz}}$
		25°C	19			19			
$V_{N(PP)}$	Peak-to-peak equivalent input noise voltage $f = 0.1\text{ Hz to }1\text{ Hz}$ $f = 0.1\text{ Hz to }10\text{ Hz}$	25°C	0.7			0.7			$\mu$ V
		25°C	1.1			1.1			
$I_n$	Equivalent input noise current	25°C	0.6			0.6			fA/ $\sqrt{\text{Hz}}$
THD + N	Total harmonic distortion plus noise $V_O = 0.5\text{ V to }2.5\text{ V}$ , $f = 10\text{ kHz}$ , $R_L = 50\text{ k}\Omega$ ‡	25°C	$A_V = 1$			0.2%			
			$A_V = 10$			1%			
	Gain-bandwidth product $f = 50\text{ kHz}$ , $C_L = 100\text{ pF}$ ‡	25°C	$R_L = 50\text{ k}\Omega$ ‡			0.2			MHz
$B_{OM}$	Maximum output-swing bandwidth $V_{O(PP)} = 2\text{ V}$ , $R_L = 50\text{ k}\Omega$ ‡	25°C	$A_V = 1$ , $C_L = 100\text{ pF}$ ‡			30			kHz
$\phi_m$	Phase margin at unity gain $R_L = 50\text{ k}\Omega$ ‡, $C_L = 100\text{ pF}$ ‡	25°C	63°			63°			
		25°C	15			15			dB

† Full range is  $-40^\circ\text{C}$  to  $125^\circ\text{C}$  for Q suffix.

‡ Referenced to 2.5 V

**TLC225x-EP, TLC225xA-EP**  
**Advanced LinCMOS™ RAIL-TO-RAIL**  
**VERY LOW-POWER OPERATIONAL AMPLIFIERS**

SGLS216 – NOVEMBER 2003

**electrical characteristics at specified free-air temperature,  $V_{DD\pm} = \pm 5$  V (unless otherwise noted)**

PARAMETER	TEST CONDITIONS	$T_A$ †	TLC2252-EP			TLC2252A-EP			UNIT
			MIN	TYP	MAX	MIN	TYP	MAX	
$V_{IO}$ Input offset voltage	$V_{IC} = 0, V_O = 0, R_S = 50 \Omega$	25°C	200	1500		200	850	$\mu V$	
		Full range			1750		1000		
$\alpha_{VIO}$ Temperature coefficient of input offset voltage		25°C to 125°C	0.5		0.5		$\mu V/^\circ C$		
Input offset voltage long-term drift (see Note 4)		25°C	0.003		0.003		$\mu V/mo$		
$I_{IO}$ Input offset current		25°C	0.5	60	0.5	60	$pA$		
		Full range	1000		1000				
$I_{IB}$ Input bias current	25°C	1	60	1	60	$pA$			
	Full range	1000		1000					
$V_{ICR}$ Common-mode input voltage range	$R_S = 50 \Omega,  V_{IO}  \leq 5$ mV	25°C	-5 to 4	-5.3 to 4.2	-5 to 4	-5.3 to 4.2	V		
		Full range	-5 to 3.5		-5 to 3.5				
$V_{OM+}$ Maximum positive peak output voltage	$I_O = -20 \mu A$	25°C	4.98		4.98		V		
	$I_O = -100 \mu A$	25°C	4.9	4.93	4.9	4.93			
		Full range	4.7		4.7				
	$I_O = -200 \mu A$	25°C	4.8	4.86	4.8	4.86			
$V_{OM-}$ Maximum negative peak output voltage	$V_{IC} = 0, I_O = 50 \mu A$	25°C	-4.99		-4.99		V		
		25°C	-4.85	-4.91	-4.85	-4.91			
	Full range	-4.85		-4.85					
	$V_{IC} = 0, I_O = 4$ mA	25°C	-4	-4.3	-4	-4.3			
		Full range	-3.8		-3.8				
	$A_{VD}$ Large-signal differential voltage amplification	$V_O = \pm 4$ V	$R_L = 100$ k $\Omega$	25°C	40	150		40	150
Full range				10		10			
$R_L = 1$ M $\Omega$			25°C	3000		3000			
$r_{id}$ Differential input resistance		25°C	$10^{12}$			$\Omega$			
$r_{ic}$ Common-mode input resistance		25°C	$10^{12}$			$\Omega$			
$C_{ic}$ Common-mode input capacitance	f = 10 kHz, P package	25°C	8			pF			
$z_o$ Closed-loop output impedance	f = 25 kHz, $A_V = 10$	25°C	190			$\Omega$			
CMRR Common-mode rejection ratio	$V_{IC} = -5$ V to 2.7 V, $V_O = 0, R_S = 50 \Omega$	25°C	75	88	75	88	dB		
		Full range	75		75				
$k_{SVR}$ Supply-voltage rejection ratio ( $\Delta V_{DD\pm} / \Delta V_{IO}$ )	$V_{DD} = \pm 2.2$ V to $\pm 8$ V, $V_{IC} = 0, No$ load	25°C	80	95	80	95	dB		
		Full range	80		80				
$I_{DD}$ Supply current	$V_O = 2.5$ V, No load	25°C	80	125	80	125	$\mu A$		
		Full range	150		150				

† Full range is -40°C to 125°C for Q suffix.

NOTE 4: Typical values are based on the input offset voltage shift observed through 500 hours of operating life test at  $T_A = 150^\circ C$  extrapolated to  $T_A = 25^\circ C$  using the Arrhenius equation and assuming an activation energy of 0.96 eV.



**TLC225x-EP, TLC225xA-EP**  
**Advanced LinCMOS™ RAIL-TO-RAIL**  
**VERY LOW-POWER OPERATIONAL AMPLIFIERS**

SGLS216 – NOVEMBER 2003

operating characteristics at specified free-air temperature,  $V_{DD\pm} = \pm 5\text{ V}$

PARAMETER	TEST CONDITIONS	$T_A^\dagger$	TLC2252-EP			TLC2252A-EP			UNIT
			MIN	TYP	MAX	MIN	TYP	MAX	
SR	Slew rate at unity gain $V_O = \pm 2\text{ V}$ , $C_L = 100\text{ pF}$ , $R_L = 100\text{ k}\Omega$	25°C	0.07	0.12		0.07	0.12		V/ $\mu\text{s}$
		Full range	0.05			0.05			
$V_n$	Equivalent input noise voltage	f = 10 Hz	25°C			38			nV/ $\sqrt{\text{Hz}}$
		f = 1 kHz	25°C			19			
$V_{N(PP)}$	Peak-to-peak equivalent input noise voltage	f = 0.1 Hz to 1 Hz	25°C			0.8			$\mu\text{V}$
		f = 0.1 Hz to 10 Hz	25°C			1.1			
$I_n$	Equivalent input noise current	25°C	0.6			0.6			fA/ $\sqrt{\text{Hz}}$
THD + N	Total harmonic distortion plus noise $V_O = \pm 2.3\text{ V}$ , $R_L = 50\text{ k}\Omega$ , f = 10 kHz	$A_V = 1$	25°C			0.2%			
		$A_V = 10$	25°C			1%			
	Gain-bandwidth product f = 10 kHz, $C_L = 100\text{ pF}$ , $R_L = 50\text{ k}\Omega$	25°C	0.21			0.21			MHz
BOM	Maximum output-swing bandwidth $V_{O(PP)} = 4.6\text{ V}$ , $R_L = 50\text{ k}\Omega$ , $C_L = 100\text{ pF}$ , $A_V = 1$	25°C	14			14			kHz
$\phi_m$	Phase margin at unity gain $R_L = 50\text{ k}\Omega$ , $C_L = 100\text{ pF}$	25°C	63°			63°			
		25°C	15			15			dB

$^\dagger$  Full range is  $-40^\circ\text{C}$  to  $125^\circ\text{C}$  for Q suffix.



**TLC225x-EP, TLC225xA-EP**  
**Advanced LinCMOS™ RAIL-TO-RAIL**  
**VERY LOW-POWER OPERATIONAL AMPLIFIERS**

SGLS216 – NOVEMBER 2003

**electrical characteristics at specified free-air temperature,  $V_{DD} = 5\text{ V}$  (unless otherwise noted)**

PARAMETER	TEST CONDITIONS	$T_A$ †	TLC2254-EP			TLC2254A-EP			UNIT
			MIN	TYP	MAX	MIN	TYP	MAX	
$V_{IO}$ Input offset voltage		25°C	200	1500		200	850	$\mu\text{V}$	
		Full range			1750		1000		
$\alpha_{VIO}$ Temperature coefficient of input offset voltage		25°C to 125°C	0.5			0.5			$\mu\text{V}/^\circ\text{C}$
Input offset voltage long-term drift (see Note 4)	$V_{DD\pm} = \pm 2.5\text{ V}$ , $V_{IC} = 0$ , $V_O = 0$ , $R_S = 50\ \Omega$	25°C	0.003			0.003			$\mu\text{V}/\text{mo}$
$I_{IO}$ Input offset current		25°C	0.5	60		0.5	60	$\text{pA}$	
		125°C			1000		1000		
$I_{IB}$ Input bias current		25°C	1	60		1	60	$\text{pA}$	
		125°C			1000		1000		
$V_{ICR}$ Common-mode input voltage range	$R_S = 50\ \Omega$ , $ V_{IO}  \leq 5\text{ mV}$	25°C	0 to 4	-0.3 to 4.2		0 to 4	-0.3 to 4.2	$\text{V}$	
		Full range	0 to 3.5			0 to 3.5			
$V_{OH}$ High-level output voltage	$I_{OH} = -20\ \mu\text{A}$	25°C	4.98			4.98			$\text{V}$
	$I_{OH} = -75\ \mu\text{A}$	25°C	4.9	4.94		4.9	4.94		
	Full range		4.8			4.8			
$V_{OL}$ Low-level output voltage	$V_{IC} = 2.5\text{ V}$ , $I_{OL} = 50\ \mu\text{A}$	25°C	0.01			0.01			$\text{V}$
	$V_{IC} = 2.5\text{ V}$ , $I_{OL} = 500\ \mu\text{A}$	25°C	0.09	0.15		0.09	0.15		
	Full range			0.15			0.15		
	$V_{IC} = 2.5\text{ V}$ , $I_{OL} = 4\text{ mA}$	25°C	0.8	1		0.7	1		
$A_{VD}$ Large-signal differential voltage amplification	$V_{IC} = 2.5\text{ V}$ , $V_O = 1\text{ V to }4\text{ V}$	$R_L = 100\text{ k}\Omega$ ‡	25°C	100	350		100	350	$\text{V}/\text{mV}$
		Full range		10			10		
		$R_L = 1\text{ M}\Omega$ ‡	25°C	1700			1700		
$r_{i(d)}$ Differential input resistance		25°C	$10^{12}$			$10^{12}$			$\Omega$
$r_{i(c)}$ Common-mode input resistance		25°C	$10^{12}$			$10^{12}$			$\Omega$
$c_{i(c)}$ Common-mode input capacitance	$f = 10\text{ kHz}$ , N package	25°C	8			8			$\text{pF}$
$z_o$ Closed-loop output impedance	$f = 25\text{ kHz}$ , $A_V = 10$	25°C	200			200			$\Omega$
CMRR Common-mode rejection ratio	$V_{IC} = 0\text{ to }2.7\text{ V}$ , $V_O = 2.5\text{ V}$ , $R_S = 50\ \Omega$	25°C	70	83		70	83	$\text{dB}$	
		Full range	70			70			
$k_{SVR}$ Supply-voltage rejection ratio ( $\Delta V_{DD}/\Delta V_{IO}$ )	$V_{DD} = 4.4\text{ V to }16\text{ V}$ , $V_{IC} = V_{DD}/2$ , No load	25°C	80	95		80	95	$\text{dB}$	
		Full range	80			80			
$I_{DD}$ Supply current (four amplifiers)	$V_O = 2.5\text{ V}$ , No load	25°C	140	250		140	250	$\mu\text{A}$	
		Full range		300			300		

† Full range is  $-40^\circ\text{C}$  to  $125^\circ\text{C}$  for Q suffix.

‡ Referenced to 2.5 V

NOTE 4: Typical values are based on the input offset voltage shift observed through 500 hours of operating life test at  $T_A = 150^\circ\text{C}$  extrapolated to  $T_A = 25^\circ\text{C}$  using the Arrhenius equation and assuming an activation energy of 0.96 eV.



**TLC225x-EP, TLC225xA-EP**  
**Advanced LinCMOS™ RAIL-TO-RAIL**  
**VERY LOW-POWER OPERATIONAL AMPLIFIERS**

SGLS216 – NOVEMBER 2003

operating characteristics at specified free-air temperature,  $V_{DD} = 5\text{ V}$

PARAMETER	TEST CONDITIONS	$T_A$ †	TLC2254-EP			TLC2254A-EP			UNIT
			MIN	TYP	MAX	MIN	TYP	MAX	
SR	Slew rate at unity gain $V_O = 0.5\text{ V to }3.5\text{ V}$ , $R_L = 100\text{ k}\Omega$ ‡, $C_L = 100\text{ pF}$ ‡	25°C	0.07	0.12		0.07	0.12		V/ $\mu$ s
		Full range	0.05			0.05			
$V_n$	Equivalent input noise voltage $f = 10\text{ Hz}$ $f = 1\text{ kHz}$	25°C	36			36			nV/ $\sqrt{\text{Hz}}$
		25°C	19			19			
$V_{N(PP)}$	Peak-to-peak equivalent input noise voltage $f = 0.1\text{ Hz to }1\text{ Hz}$ $f = 0.1\text{ Hz to }10\text{ Hz}$	25°C	0.7			0.7			$\mu$ V
		25°C	1.1			1.1			
$I_n$	Equivalent input noise current	25°C	0.6			0.6			fA/ $\sqrt{\text{Hz}}$
THD + N	Total harmonic distortion plus noise $V_O = 0.5\text{ V to }2.5\text{ V}$ , $f = 20\text{ kHz}$ , $R_L = 50\text{ k}\Omega$ ‡	25°C	$A_V = 1$			0.2%			
			$A_V = 10$			1%			
	Gain-bandwidth product $f = 50\text{ kHz}$ , $C_L = 100\text{ pF}$ ‡	$R_L = 50\text{ k}\Omega$ ‡, 25°C	0.2			0.2			MHz
$B_{OM}$	Maximum output-swing bandwidth $V_{O(PP)} = 2\text{ V}$ , $R_L = 50\text{ k}\Omega$ ‡, $A_V = 1$ , $C_L = 100\text{ pF}$ ‡	25°C	30			30			kHz
$\phi_m$	Phase margin at unity gain $R_L = 50\text{ k}\Omega$ ‡, $C_L = 100\text{ pF}$ ‡	25°C	63°			63°			
		25°C	15			15			dB

† Full range is  $-40^\circ\text{C}$  to  $125^\circ\text{C}$  for Q suffix.

‡ Referenced to 2.5 V



**TLC225x-EP, TLC225xA-EP**  
**Advanced LinCMOS™ RAIL-TO-RAIL**  
**VERY LOW-POWER OPERATIONAL AMPLIFIERS**

SGLS216 – NOVEMBER 2003

**electrical characteristics at specified free-air temperature,  $V_{DD\pm} = \pm 5\text{ V}$  (unless otherwise noted)**

PARAMETER	TEST CONDITIONS	$T_A$ †	TLC2254-EP			TLC2254A-EP			UNIT
			MIN	TYP	MAX	MIN	TYP	MAX	
$V_{IO}$ Input offset voltage		25°C	200	1500		200	850	$\mu\text{V}$	
		Full range			1750		1000		
$\alpha_{VIO}$ Temperature coefficient of input offset voltage		25°C to 125°C	0.5			0.5			$\mu\text{V}/^\circ\text{C}$
Input offset voltage long-term drift (see Note 4)	$V_{IC} = 0, V_O = 0, R_S = 50\ \Omega$	25°C	0.003			0.003			$\mu\text{V}/\text{mo}$
$I_{IO}$ Input offset current		25°C	0.5	60		0.5	60	$\text{pA}$	
		125°C	1000			1000			
$I_{IB}$ Input bias current		25°C	1	60		1	60	$\text{pA}$	
		125°C	1000			1000			
$V_{ICR}$ Common-mode input voltage range		$R_S = 50\ \Omega,  V_{IO}  \leq 5\ \text{mV}$	25°C	-5 to 4	-5.3 to 4.2		-5 to 4	-5.3 to 4.2	$\text{V}$
	Full range		-5 to 3.5			-5 to 3.5			
$V_{OM+}$ Maximum positive peak output voltage	$I_O = -20\ \mu\text{A}$	25°C	4.98			4.98			$\text{V}$
	$I_O = -100\ \mu\text{A}$	25°C	4.9	4.93		4.9	4.93		
		Full range	4.7			4.7			
	$I_O = -200\ \mu\text{A}$	25°C	4.8	4.86		4.8	4.86		
$V_{OM-}$ Maximum negative peak output voltage	$V_{IC} = 0, I_O = 50\ \mu\text{A}$	25°C	-4.99			-4.99			$\text{V}$
		25°C	-4.85	-4.91		-4.85	-4.91		
	Full range	-4.85			-4.85				
	$V_{IC} = 0, I_O = 4\ \text{mA}$	25°C	-4	-4.3		-4	-4.3		
		Full range	-3.8			-3.8			
	$A_{VD}$ Large-signal differential voltage amplification	$V_O = \pm 4\ \text{V}$	$R_L = 100\ \text{k}\Omega$	25°C	40	150		40	
Full range				10			10		
$R_L = 1\ \text{M}\Omega$			25°C	3000			3000		
$r_{i(d)}$ Differential input resistance		25°C	$10^{12}$			$10^{12}$			$\Omega$
$r_{i(c)}$ Common-mode input resistance		25°C	$10^{12}$			$10^{12}$			$\Omega$
$c_{i(c)}$ Common-mode input capacitance	$f = 10\ \text{kHz}, \text{ N package}$	25°C	8			8			$\text{pF}$
$z_o$ Closed-loop output impedance	$f = 25\ \text{kHz}, A_V = 10$	25°C	190			190			$\Omega$
CMRR Common-mode rejection ratio	$V_{IC} = -5\ \text{V to } 2.7\ \text{V}, V_O = 0, R_S = 50\ \Omega$	25°C	75	88		75	88	dB	
		Full range	75			75			
$k_{SVR}$ Supply-voltage rejection ratio ( $\Delta V_{DD\pm}/\Delta V_{IO}$ )	$V_{DD\pm} = \pm 2.2\ \text{V to } \pm 8\ \text{V}, V_{IC} = V_{DD}/2, \text{ No load}$	25°C	80	95		80	95	dB	
		Full range	80			80			
$I_{DD}$ Supply current (four amplifiers)	$V_O = 0, \text{ No load}$	25°C	160	250		160	250	$\mu\text{A}$	
		Full range	300			300			

† Full range is  $-40^\circ\text{C}$  to  $125^\circ\text{C}$  for Q suffix.

NOTE 4: Typical values are based on the input offset voltage shift observed through 500 hours of operating life test at  $T_A = 150^\circ\text{C}$  extrapolated to  $T_A = 25^\circ\text{C}$  using the Arrhenius equation and assuming an activation energy of 0.96 eV.



**TLC225x-EP, TLC225xA-EP**  
**Advanced LinCMOS™ RAIL-TO-RAIL**  
**VERY LOW-POWER OPERATIONAL AMPLIFIERS**

SGLS216 – NOVEMBER 2003

operating characteristics at specified free-air temperature,  $V_{DD\pm} = \pm 5\text{ V}$

PARAMETER	TEST CONDITIONS		$T_A^\dagger$	TLC2254-EP			TLC2254A-EP			UNIT	
				MIN	TYP	MAX	MIN	TYP	MAX		
SR	Slew rate at unity gain	$V_O = \pm 2\text{ V}$ , $C_L = 100\text{ pF}$	$R_L = 100\text{ k}\Omega$	25°C	0.07	0.12		0.07	0.12	$\text{V}/\mu\text{s}$	
				Full range	0.05			0.05			
$V_n$	Equivalent input noise voltage			25°C	38			38			$\text{nV}/\sqrt{\text{Hz}}$
				25°C	19			19			
$V_{N(PP)}$	Peak-to-peak equivalent input noise voltage			25°C	0.8			0.8			$\mu\text{V}$
				25°C	1.1			1.1			
$I_n$	Equivalent input noise current			25°C	0.6			0.6			$\text{fA}/\sqrt{\text{Hz}}$
THD + N	Total harmonic distortion plus noise	$V_O = \pm 2.3\text{ V}$ , $R_L = 50\text{ k}\Omega$ , $f = 20\text{ kHz}$	$A_V = 1$	25°C	0.2%			0.2%			
					$A_V = 10$	1%			1%		
	Gain-bandwidth product	$f = 10\text{ kHz}$ , $C_L = 100\text{ pF}$	$R_L = 50\text{ k}\Omega$	25°C	0.21			0.21			MHz
$B_{OM}$	Maximum output-swing bandwidth	$V_{O(PP)} = 4.6\text{ V}$ , $R_L = 50\text{ k}\Omega$	$A_V = 1$ , $C_L = 100\text{ pF}$	25°C	14			14			kHz
$\phi_m$	Phase margin at unity gain	$R_L = 50\text{ k}\Omega$	$C_L = 100\text{ pF}$	25°C	63°			63°			
	Gain margin			25°C	15			15			dB

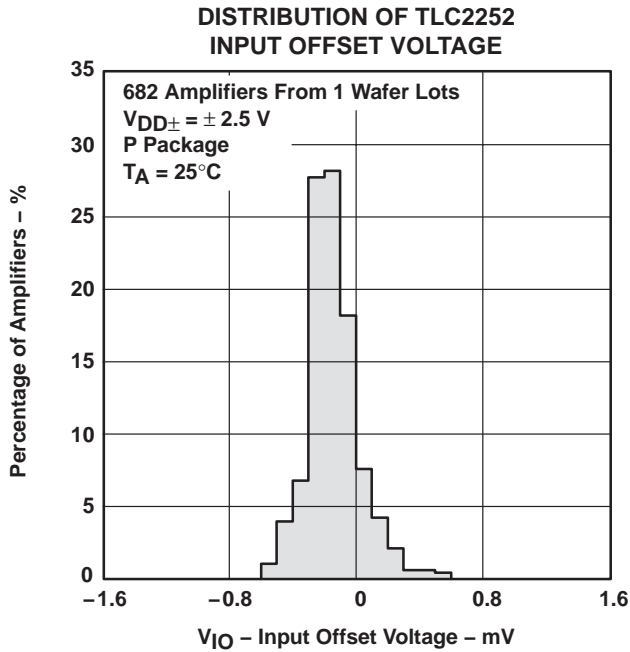
† Full range is  $-40^\circ\text{C}$  to  $125^\circ\text{C}$  for Q suffix.

**TYPICAL CHARACTERISTICS**

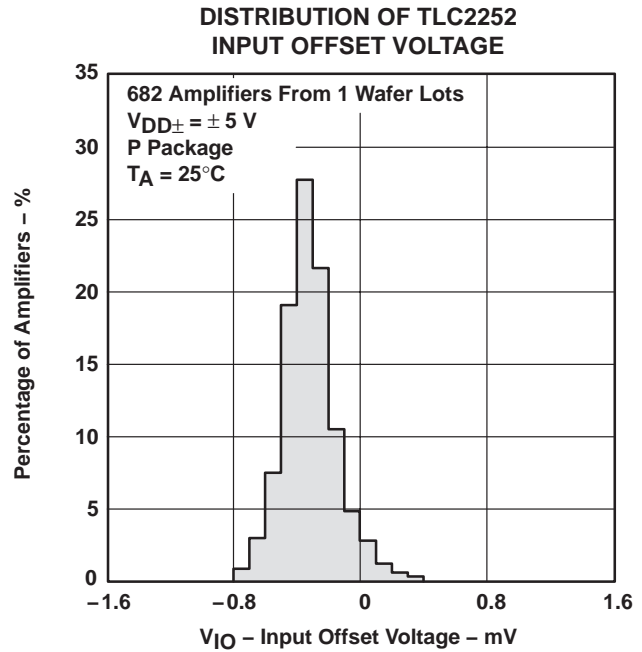
**Table of Graphs**

		<b>FIGURE</b>
$V_{IO}$	Input offset voltage	Distribution vs Common-mode input voltage
$\alpha_{VIO}$	Input offset voltage temperature coefficient	Distribution
$I_{IB}/I_{IO}$	Input bias and input offset currents	vs Free-air temperature
$V_I$	Input voltage range	vs Supply voltage vs Free-air temperature
$V_{OH}$	High-level output voltage	vs High-level output current
$V_{OL}$	Low-level output voltage	vs Low-level output current
$V_{OM+}$	Maximum positive peak output voltage	vs Output current
$V_{OM-}$	Maximum negative peak output voltage	vs Output current
$V_{O(PP)}$	Maximum peak-to-peak output voltage	vs Frequency
$I_{OS}$	Short-circuit output current	vs Supply voltage vs Free-air temperature
$V_O$	Output voltage	vs Differential input voltage
	Differential gain	vs Load resistance
$A_{VD}$	Large-signal differential voltage amplification	vs Frequency vs Free-air temperature
$z_o$	Output impedance	vs Frequency
CMRR	Common-mode rejection ratio	vs Frequency vs Free-air temperature
$k_{SVR}$	Supply-voltage rejection ratio	vs Frequency vs Free-air temperature
$I_{DD}$	Supply current	vs Supply voltage vs Free-air temperature
SR	Slew rate	vs Load capacitance vs Free-air temperature
$V_O$	Inverting large-signal pulse response	
$V_O$	Voltage-follower large-signal pulse response	
$V_O$	Inverting small-signal pulse response	
$V_O$	Voltage-follower small-signal pulse response	
$V_n$	Equivalent input noise voltage	vs Frequency
	Noise voltage (referred to input)	Over a 10-second period
	Integrated noise voltage	vs Frequency
THD + N	Total harmonic distortion plus noise	vs Frequency
	Gain-bandwidth product	vs Free-air temperature vs Supply voltage
$\phi_m$	Phase margin	vs Frequency vs Load capacitance
$A_m$	Gain margin	vs Load capacitance
$B_1$	Unity-gain bandwidth	vs Load capacitance
	Overestimation of phase margin	vs Load capacitance

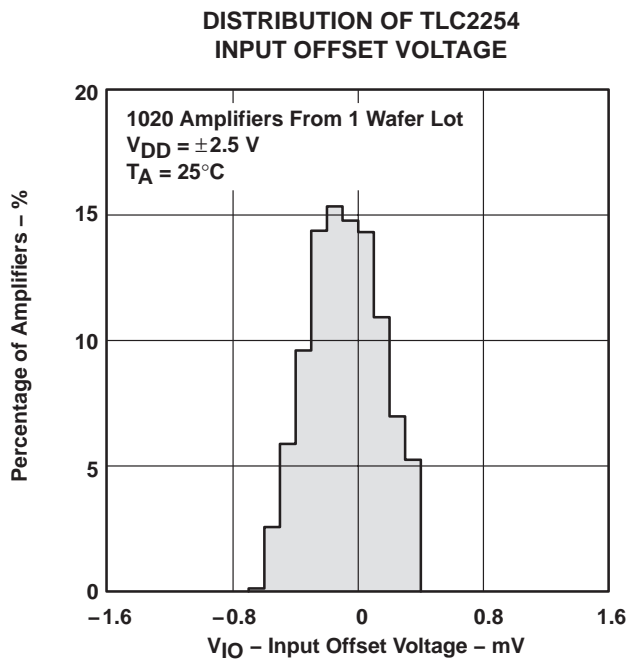
**TYPICAL CHARACTERISTICS**



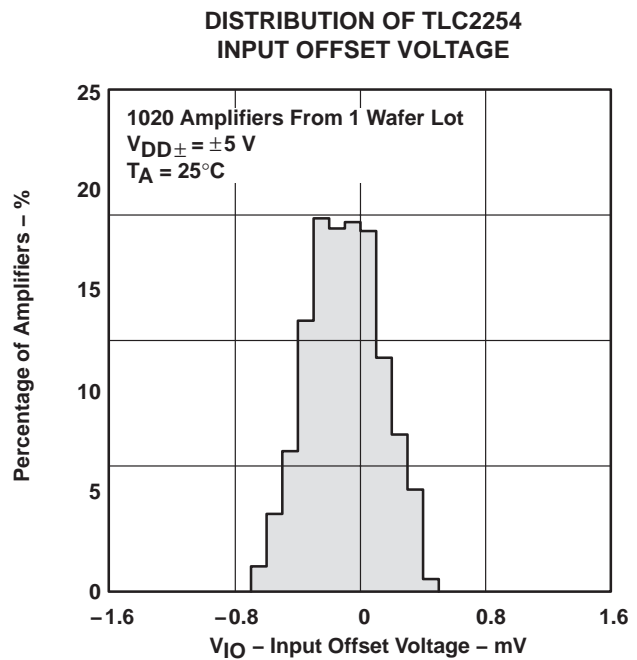
**Figure 2**



**Figure 3**

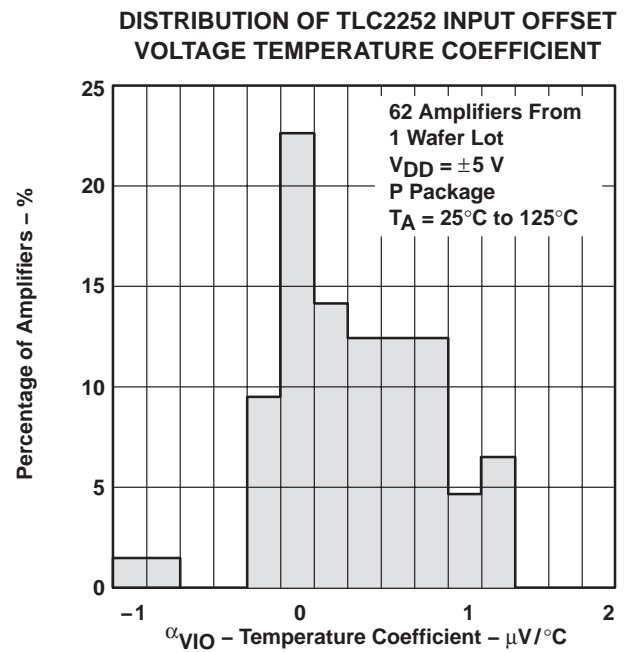
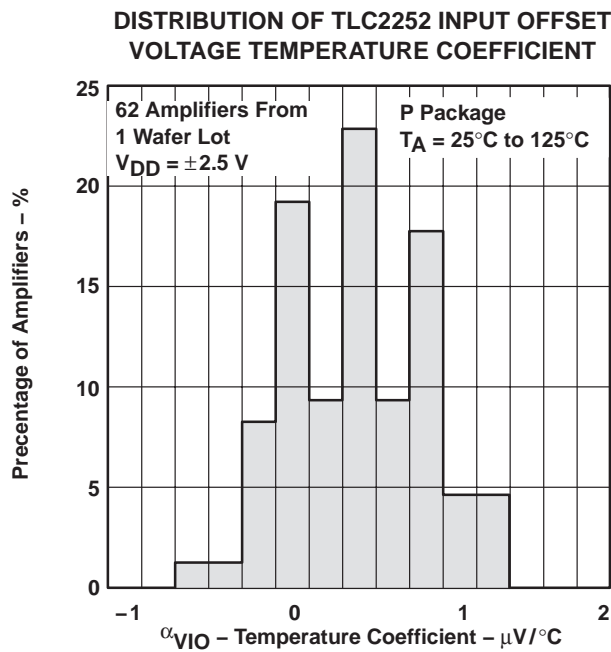
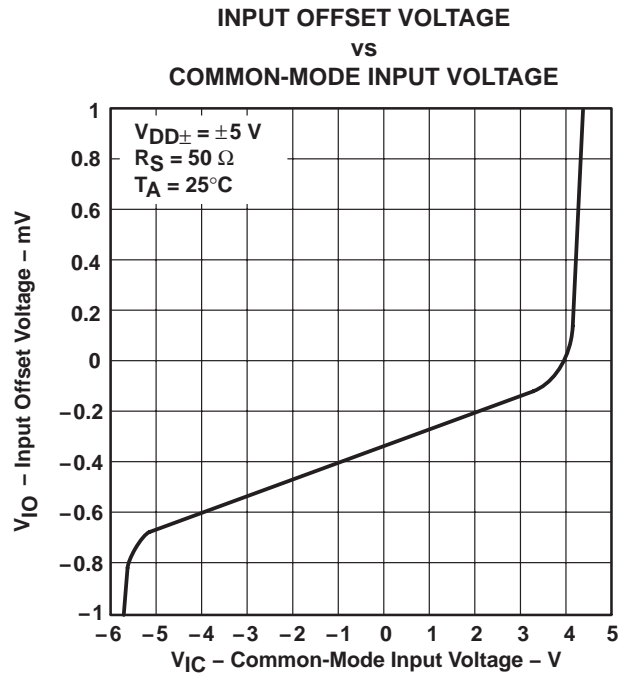
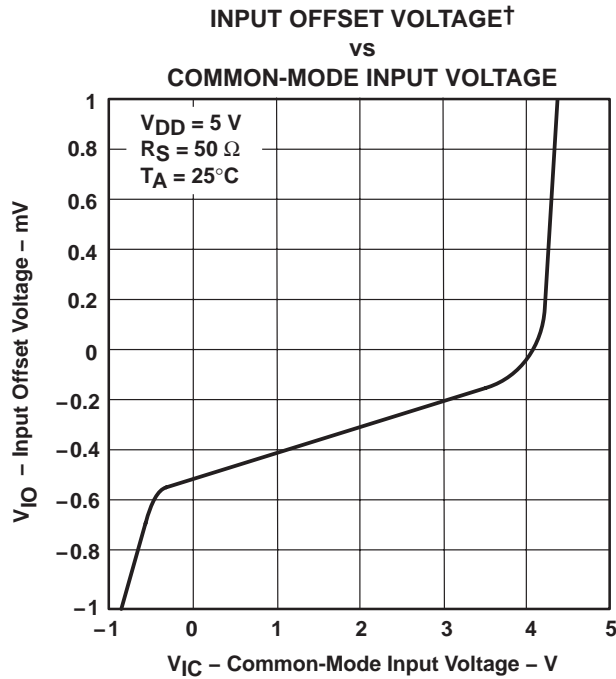


**Figure 4**



**Figure 5**

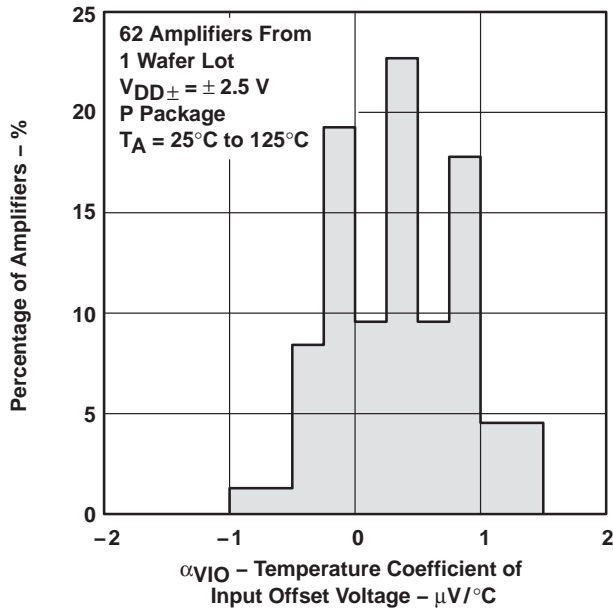
TYPICAL CHARACTERISTICS



† For curves where  $V_{DD} = 5\text{ V}$ , all loads are referenced to 2.5 V.

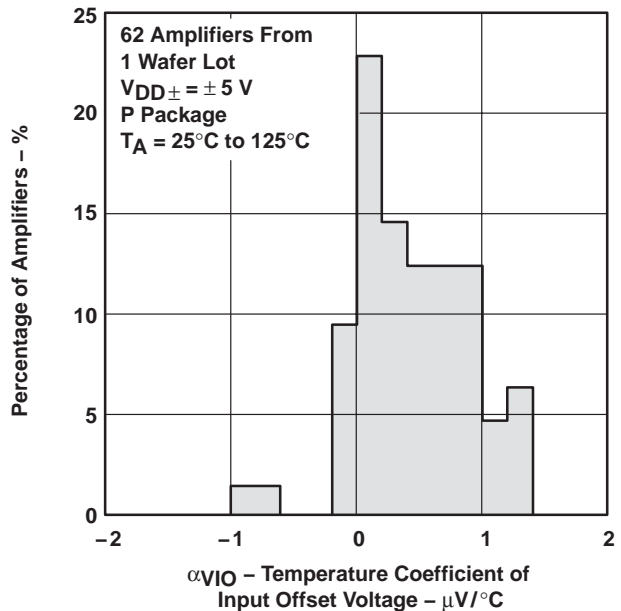
**TYPICAL CHARACTERISTICS**

**DISTRIBUTION OF TLC2254 INPUT OFFSET VOLTAGE TEMPERATURE COEFFICIENT**



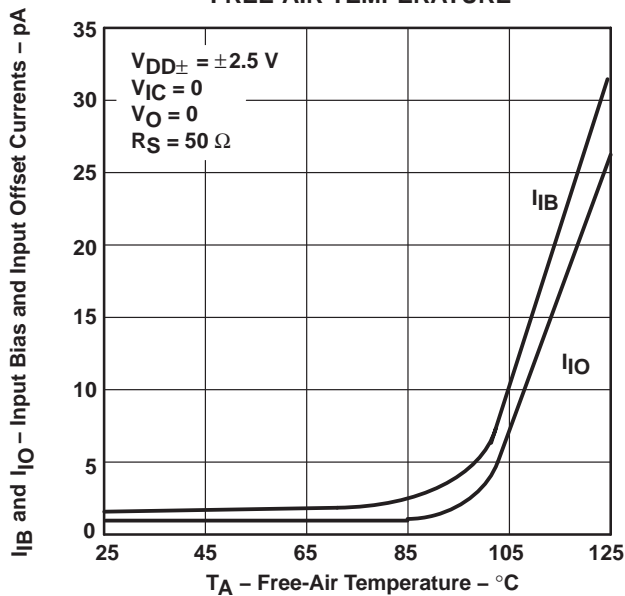
**Figure 10**

**DISTRIBUTION OF TLC2254 INPUT OFFSET VOLTAGE TEMPERATURE COEFFICIENT**



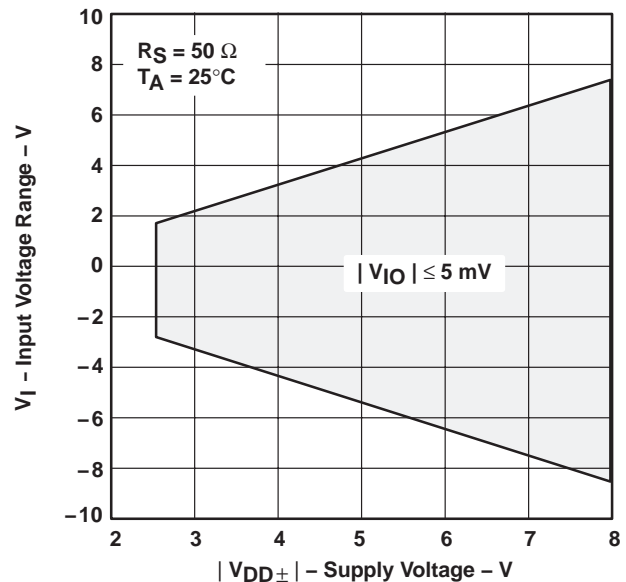
**Figure 11**

**INPUT BIAS AND INPUT OFFSET CURRENTS†**  
**vs**  
**FREE-AIR TEMPERATURE**



**Figure 12**

**INPUT VOLTAGE RANGE**  
**vs**  
**SUPPLY VOLTAGE**



**Figure 13**

† Data at high and low temperatures are applicable only within the rated operating free-air temperature ranges of the various devices.



TYPICAL CHARACTERISTICS

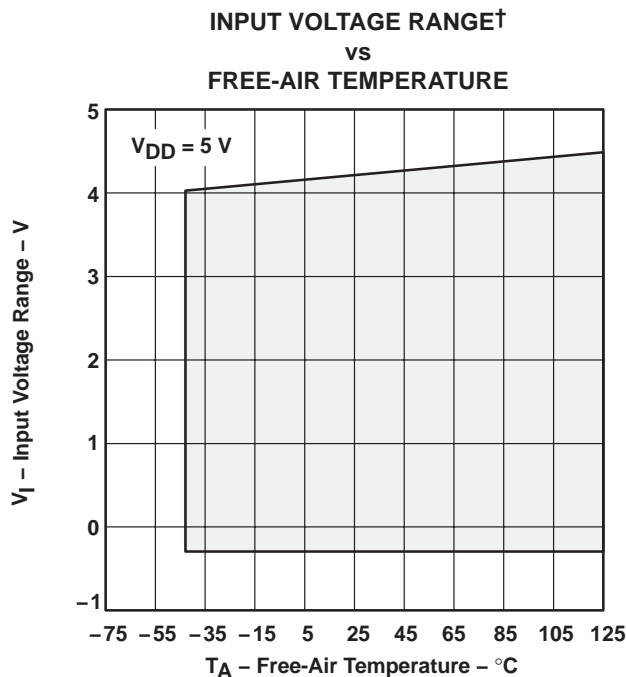


Figure 14

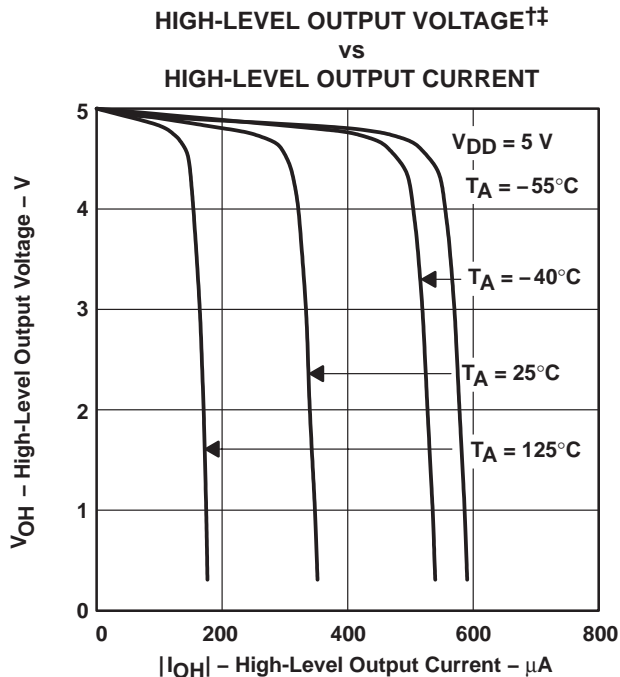


Figure 15

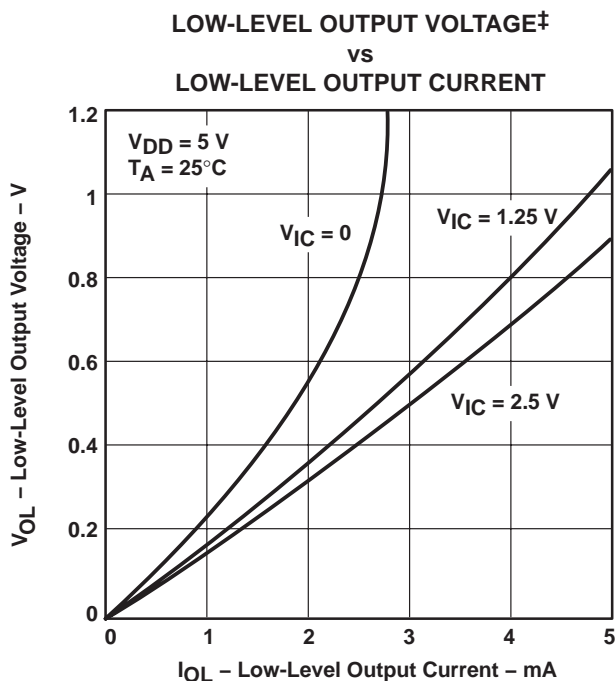


Figure 16

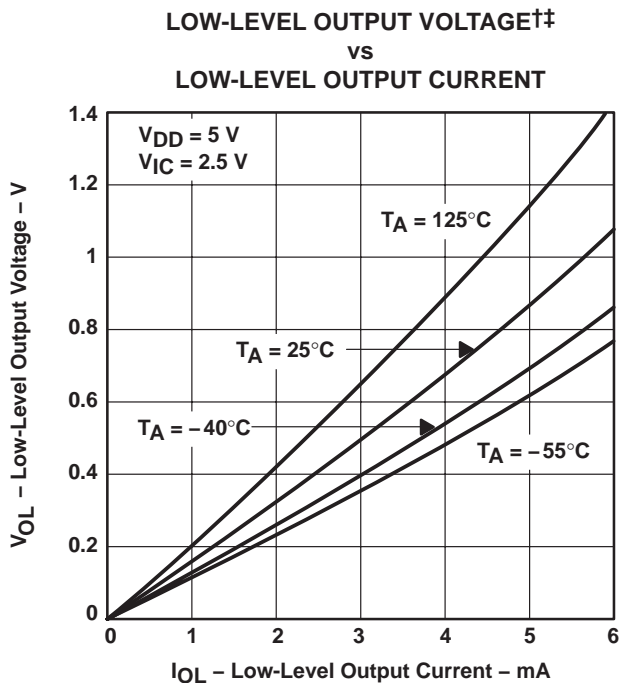
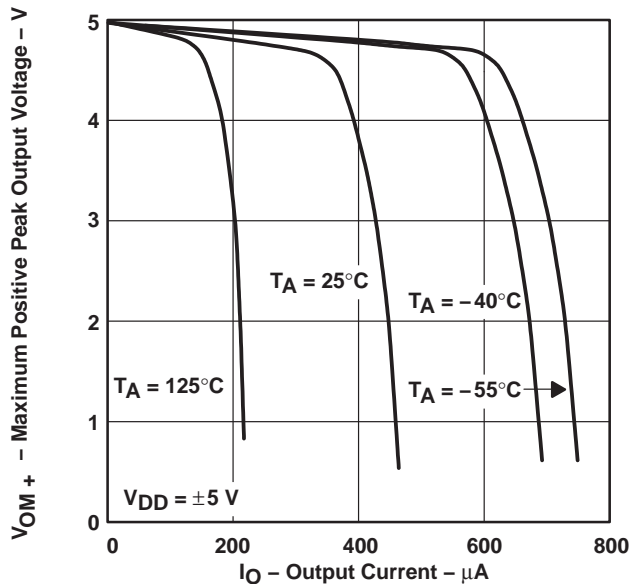


Figure 17

† Data at high and low temperatures are applicable only within the rated operating free-air temperature ranges of the various devices.  
 ‡ For curves where  $V_{DD} = 5\text{ V}$ , all loads are referenced to 2.5 V.

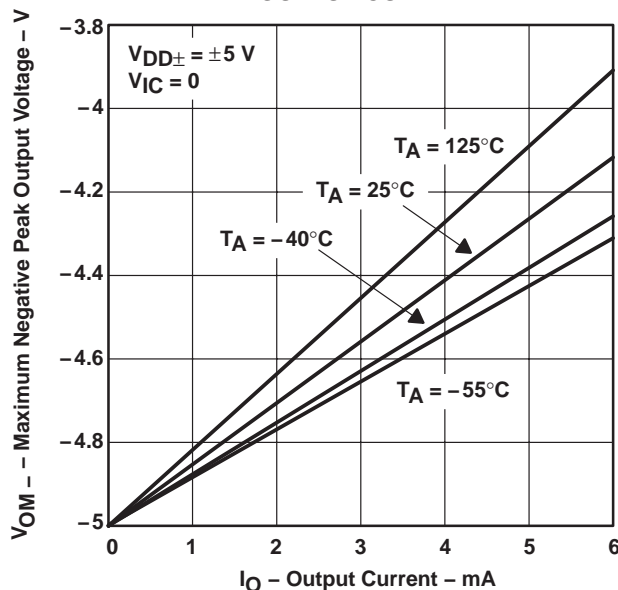
**TYPICAL CHARACTERISTICS**

**MAXIMUM POSITIVE PEAK OUTPUT VOLTAGE†**  
**vs**  
**OUTPUT CURRENT**



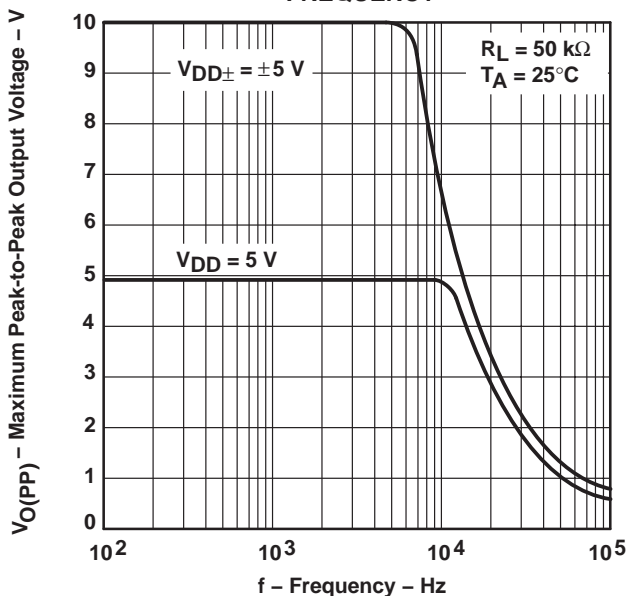
**Figure 18**

**MAXIMUM NEGATIVE PEAK OUTPUT VOLTAGE†**  
**vs**  
**OUTPUT CURRENT**



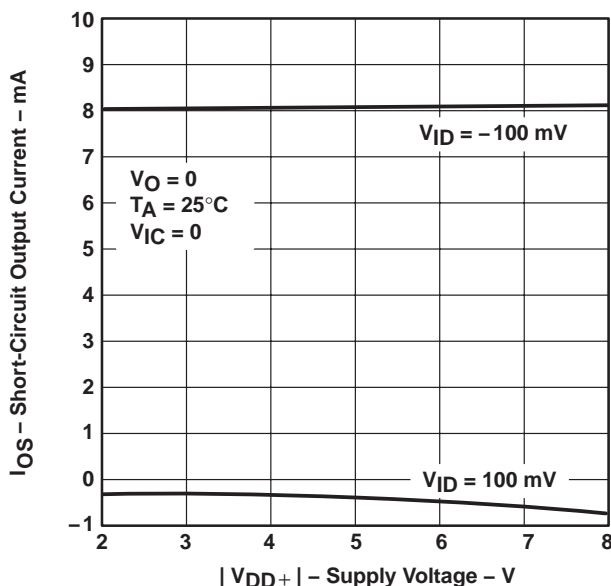
**Figure 19**

**MAXIMUM PEAK-TO-PEAK OUTPUT VOLTAGE‡**  
**vs**  
**FREQUENCY**



**Figure 20**

**SHORT-CIRCUIT OUTPUT CURRENT**  
**vs**  
**SUPPLY VOLTAGE**



**Figure 21**

† Data at high and low temperatures are applicable only within the rated operating free-air temperature ranges of the various devices.

‡ For curves where  $V_{DD} = 5\text{ V}$ , all loads are referenced to 2.5 V.

TYPICAL CHARACTERISTICS

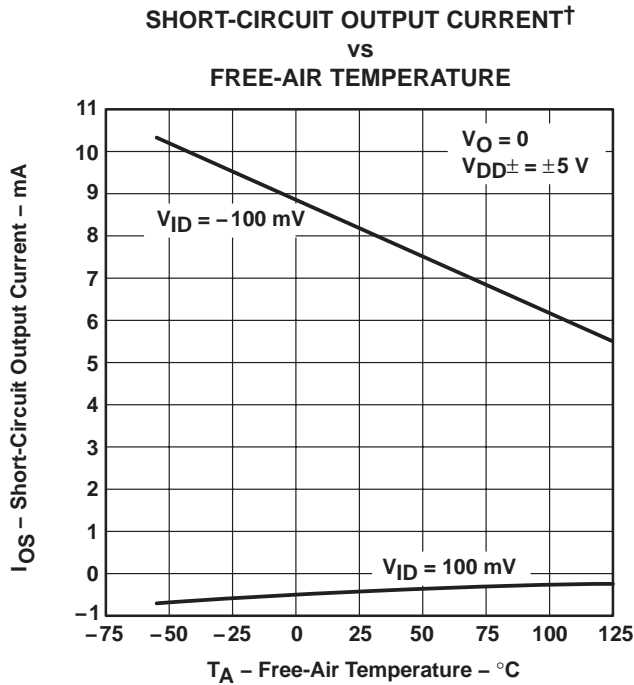


Figure 22

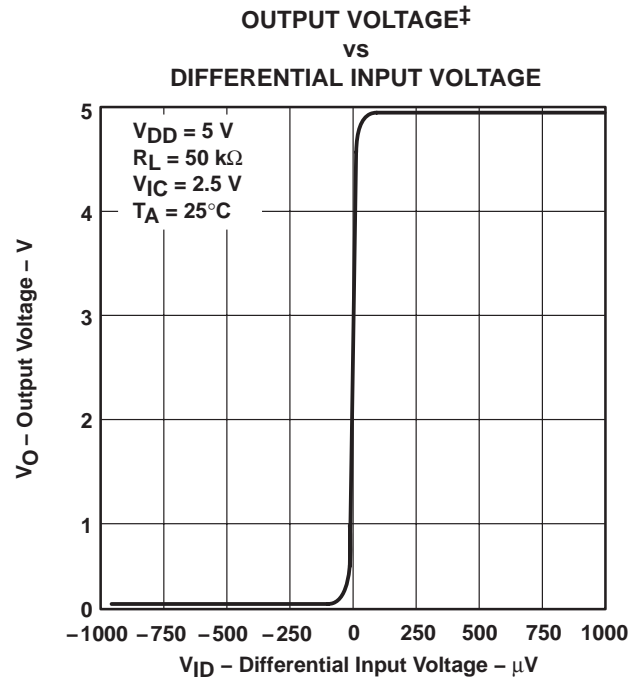


Figure 23

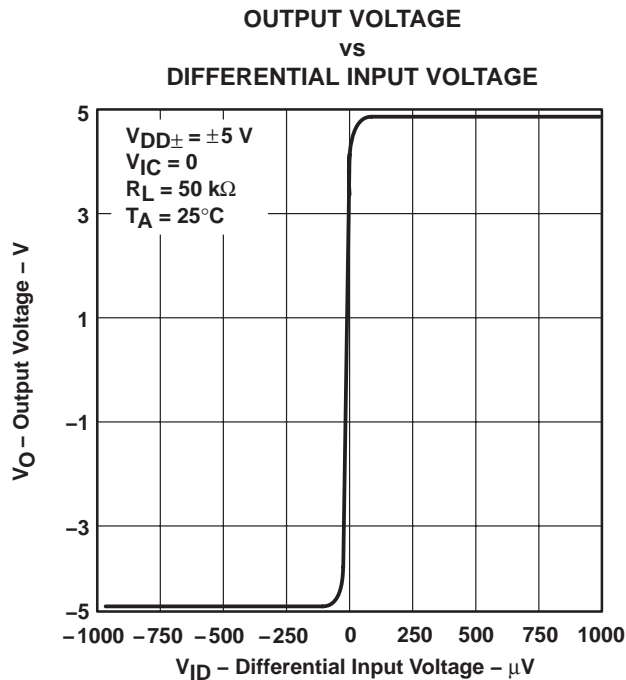


Figure 24

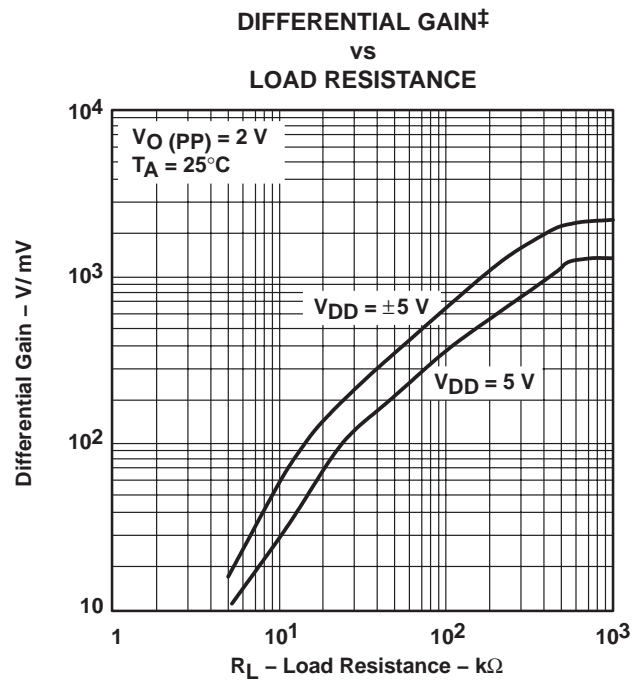


Figure 25

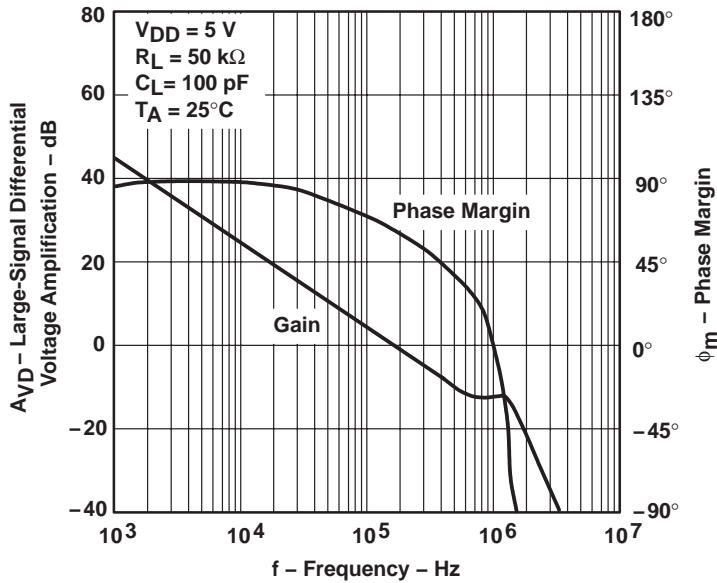
† Data at high and low temperatures are applicable only within the rated operating free-air temperature ranges of the various devices.

‡ For curves where  $V_{DD} = 5\text{ V}$ , all loads are referenced to 2.5 V.

**TYPICAL CHARACTERISTICS**

**LARGE-SIGNAL DIFFERENTIAL VOLTAGE AMPLIFICATION AND PHASE MARGIN†**

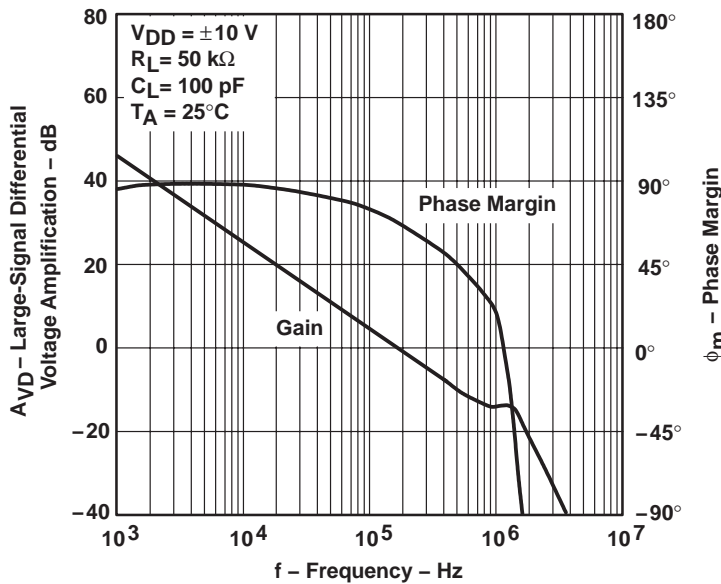
**vs**  
**FREQUENCY**



**Figure 26**

**LARGE-SIGNAL DIFFERENTIAL VOLTAGE AMPLIFICATION AND PHASE MARGIN**

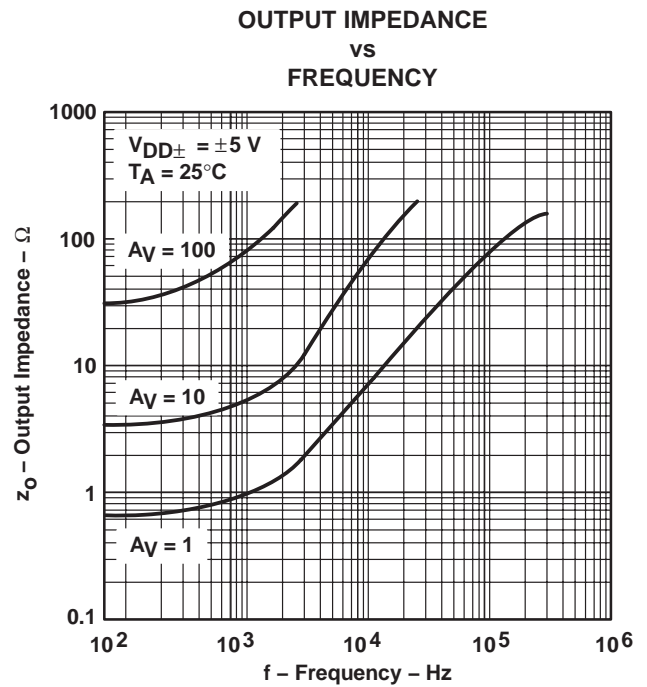
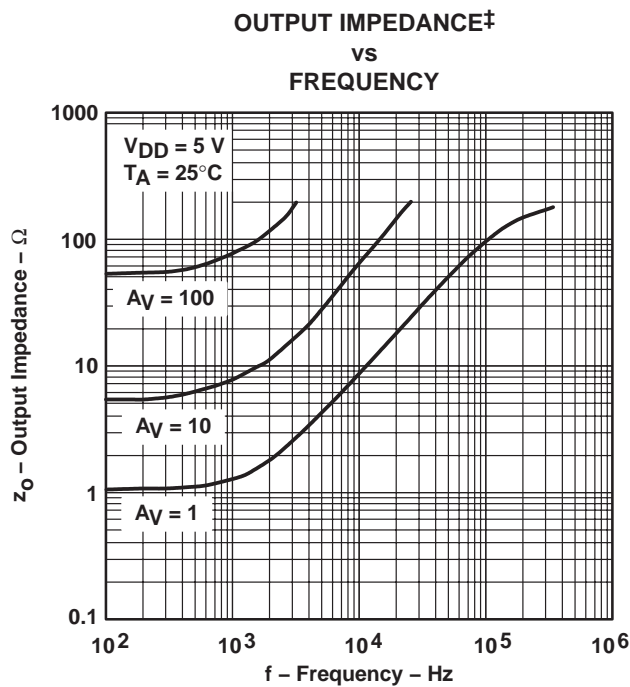
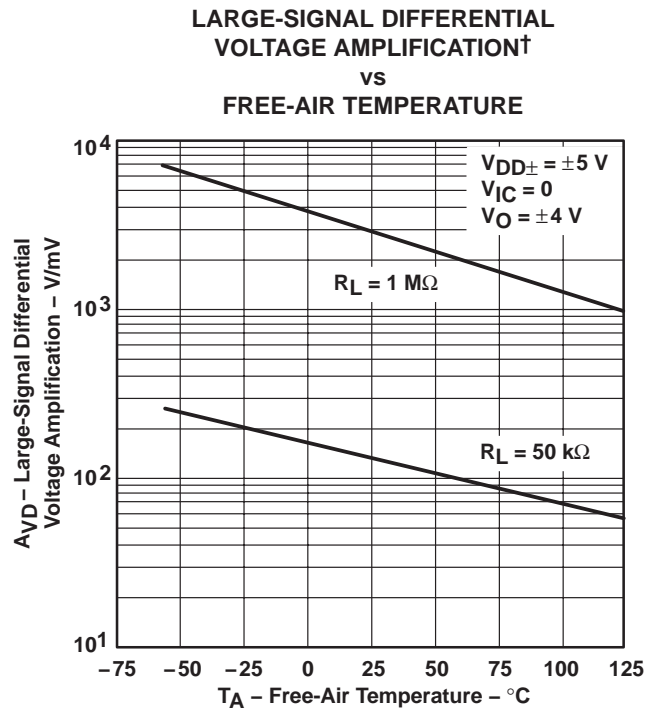
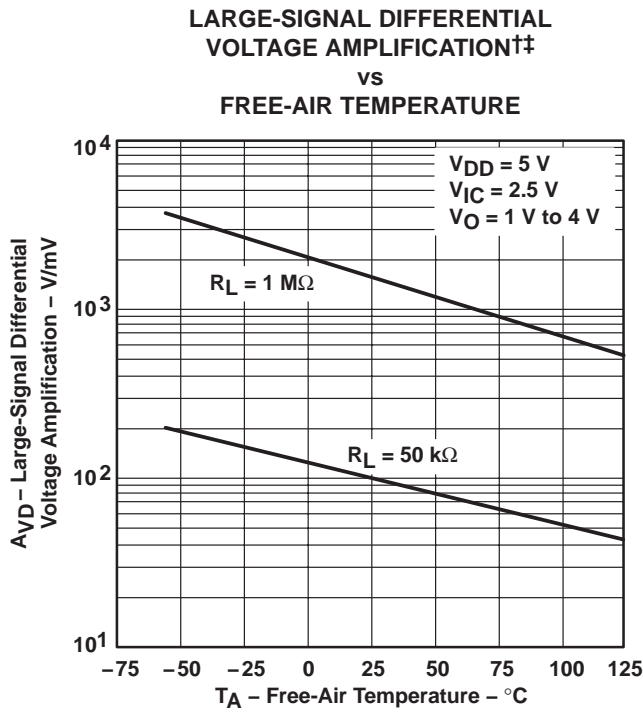
**vs**  
**FREQUENCY**



**Figure 27**

† For curves where  $V_{DD} = 5\text{ V}$ , all loads are referenced to 2.5 V.

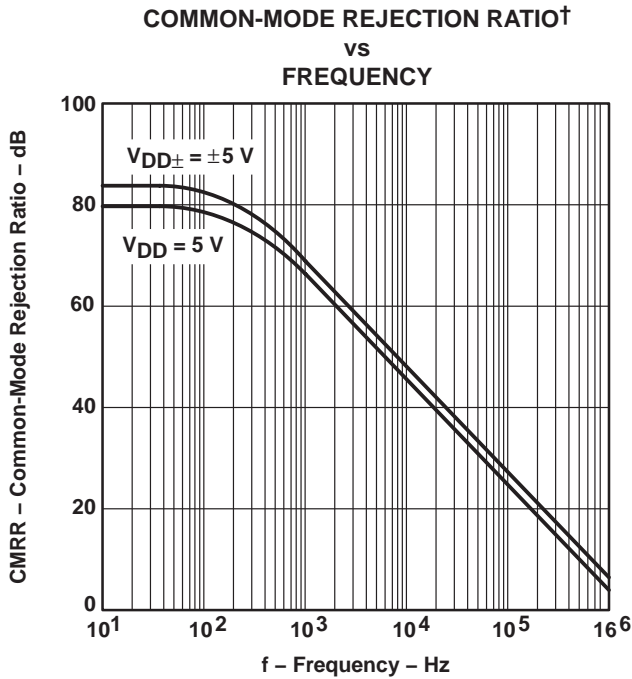
TYPICAL CHARACTERISTICS



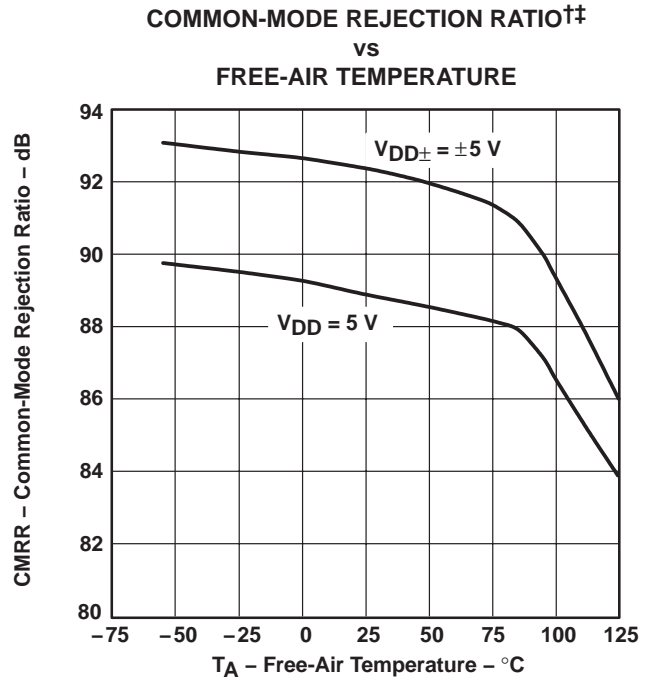
† Data at high and low temperatures are applicable only within the rated operating free-air temperature ranges of the various devices.

‡ For curves where  $V_{DD} = 5\text{ V}$ , all loads are referenced to 2.5 V.

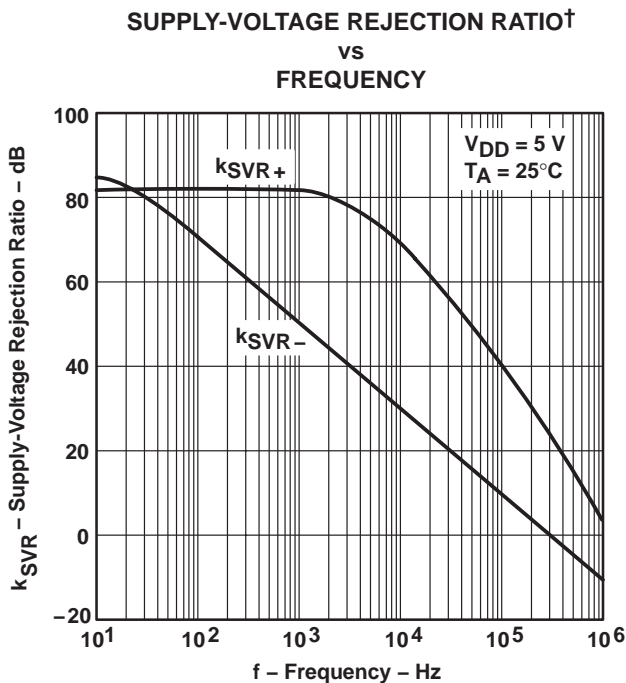
**TYPICAL CHARACTERISTICS**



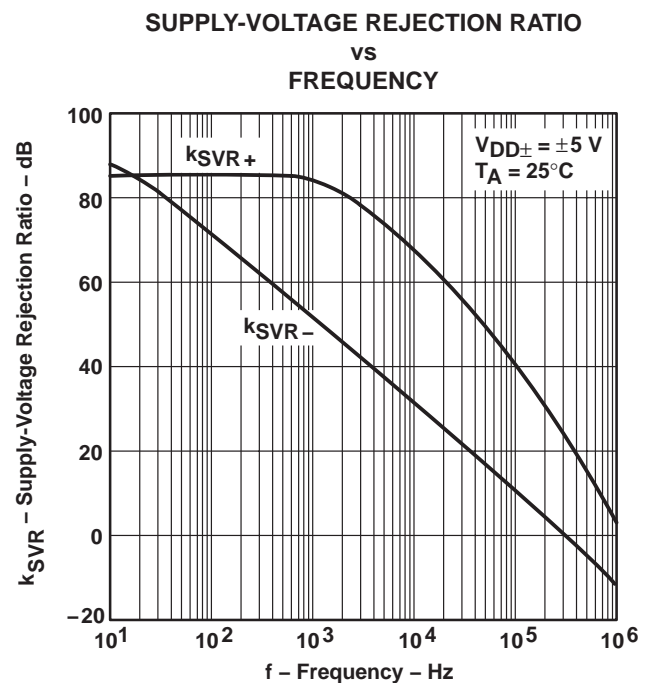
**Figure 32**



**Figure 33**



**Figure 34**



**Figure 35**

† For curves where  $V_{DD} = 5\text{ V}$ , all loads are referenced to 2.5 V.

‡ Data at high and low temperatures are applicable only within the rated operating free-air temperature ranges of the various devices.

TYPICAL CHARACTERISTICS

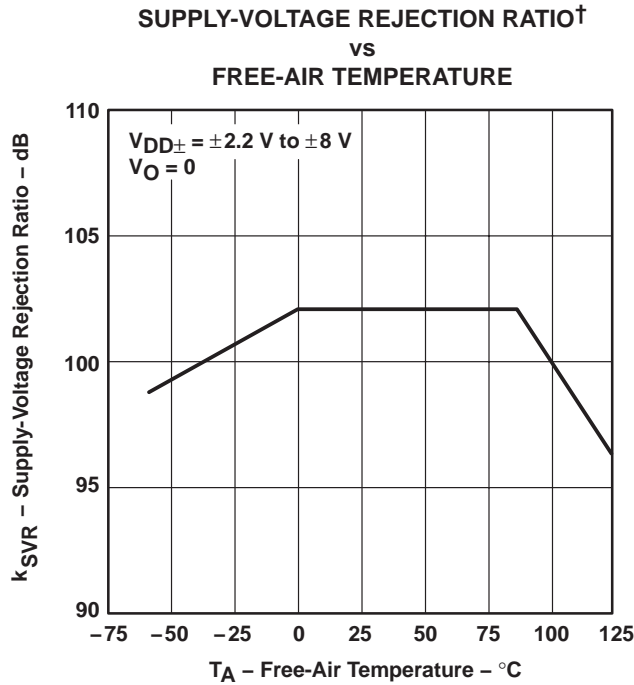


Figure 36

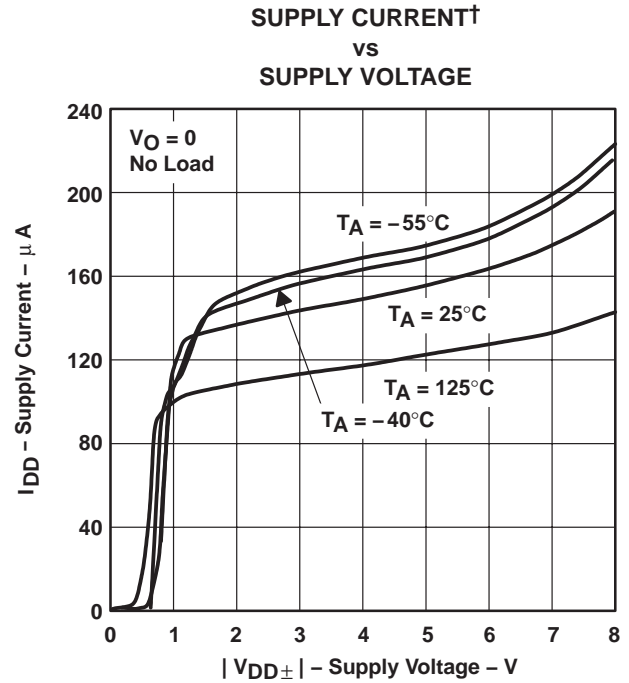


Figure 37

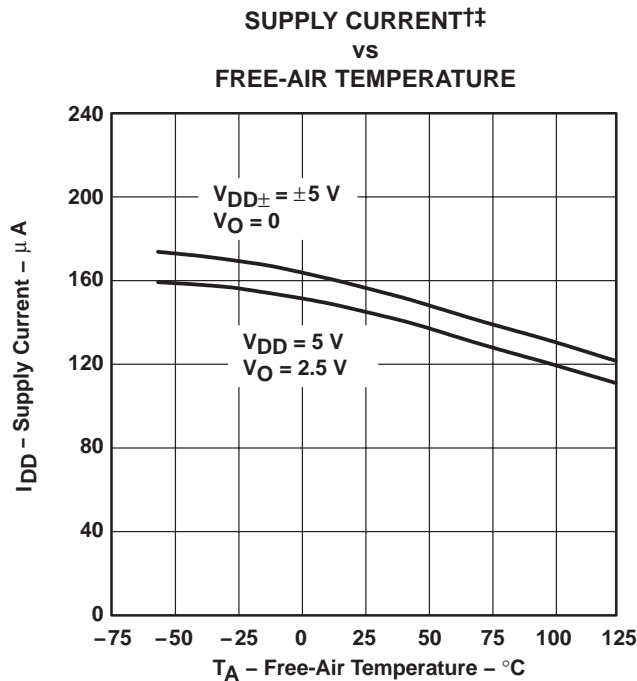


Figure 38

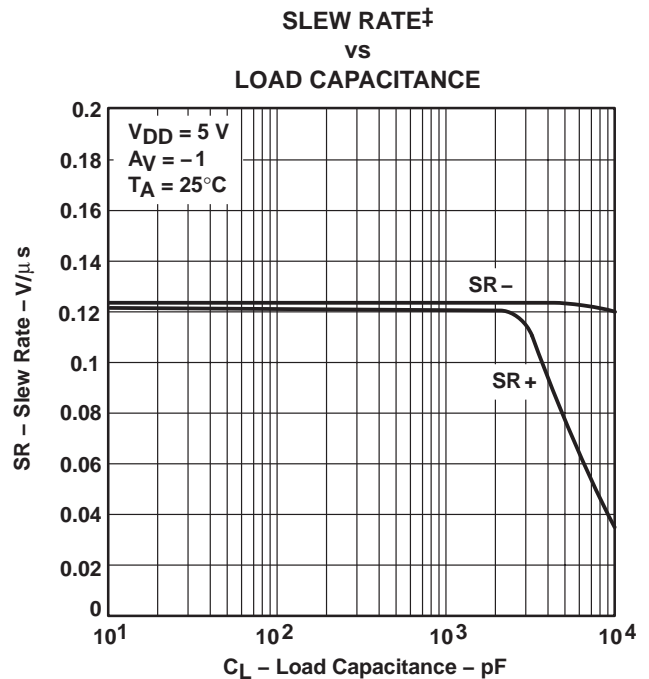
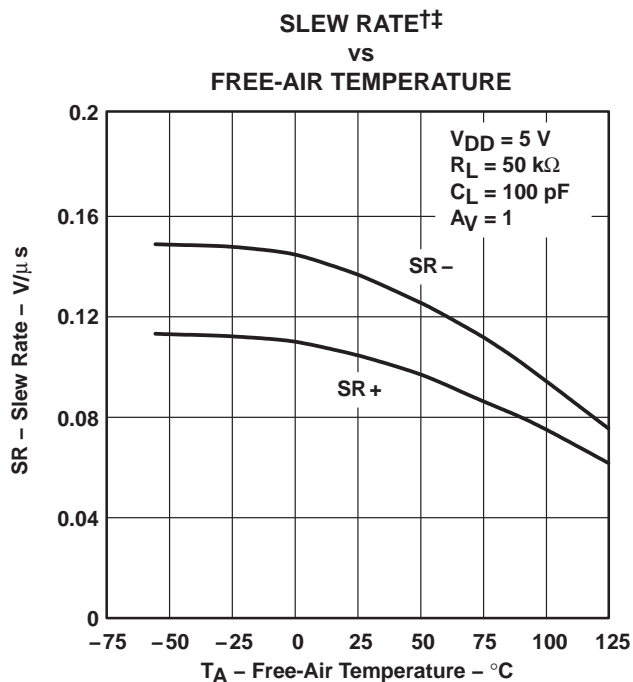


Figure 39

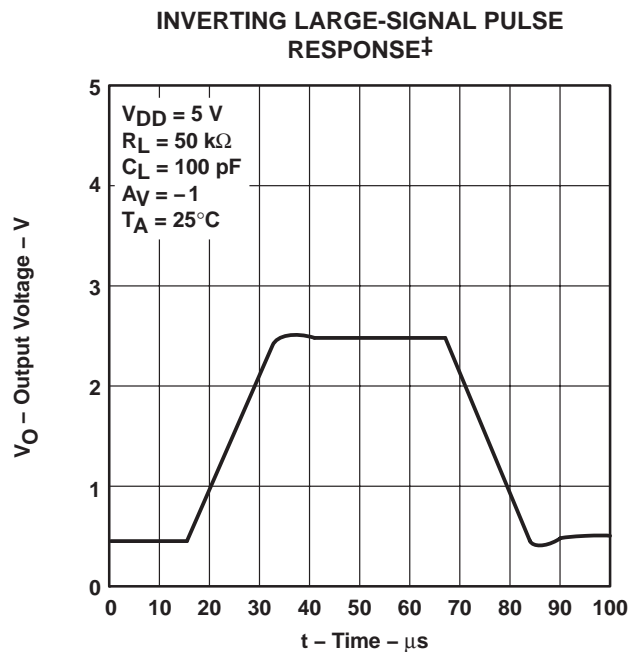
† Data at high and low temperatures are applicable only within the rated operating free-air temperature ranges of the various devices.

‡ For curves where  $V_{DD} = 5 \text{ V}$ , all loads are referenced to 2.5 V.

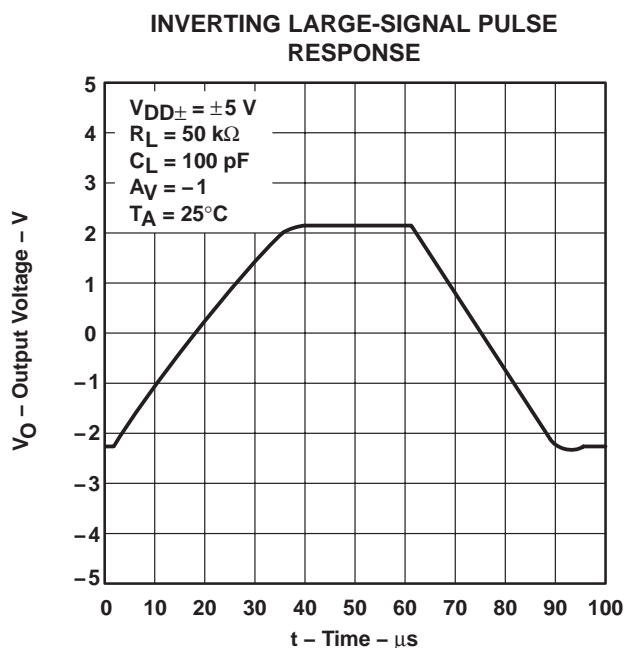
**TYPICAL CHARACTERISTICS**



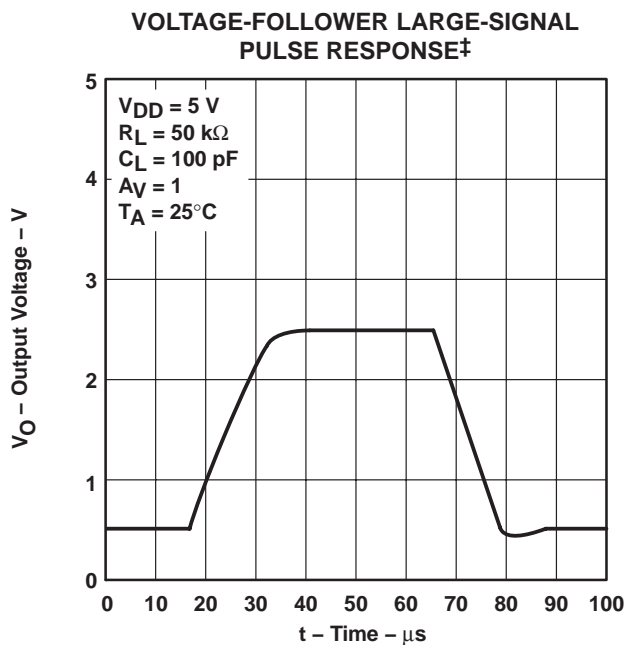
**Figure 40**



**Figure 41**



**Figure 42**



**Figure 43**

† Data at high and low temperatures are applicable only within the rated operating free-air temperature ranges of the various devices.

‡ For curves where  $V_{DD} = 5\text{ V}$ , all loads are referenced to 2.5 V.



TYPICAL CHARACTERISTICS

VOLTAGE-FOLLOWER LARGE-SIGNAL  
 PULSE RESPONSE

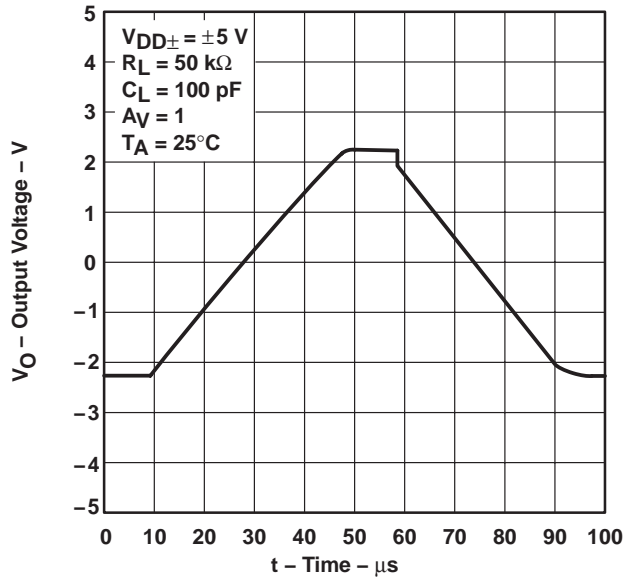


Figure 44

INVERTING SMALL-SIGNAL  
 PULSE RESPONSE†

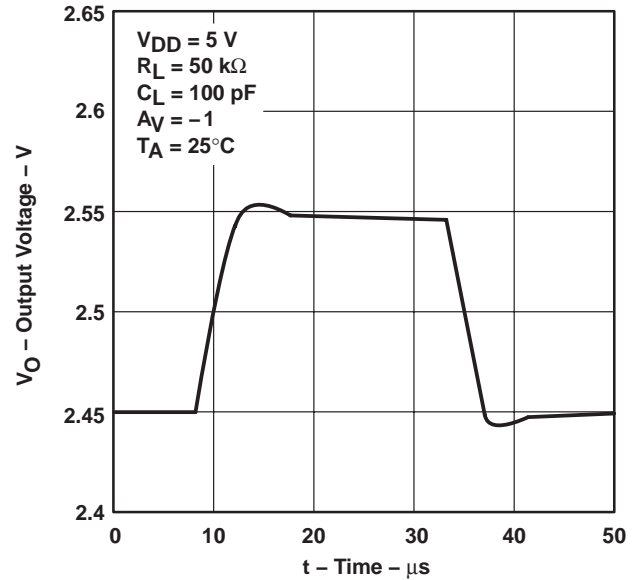


Figure 45

INVERTING SMALL-SIGNAL  
 PULSE RESPONSE

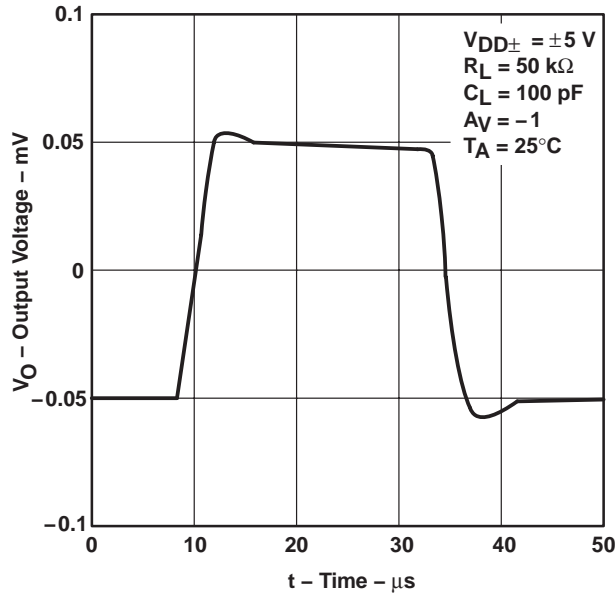


Figure 46

VOLTAGE-FOLLOWER SMALL-SIGNAL  
 PULSE RESPONSE†

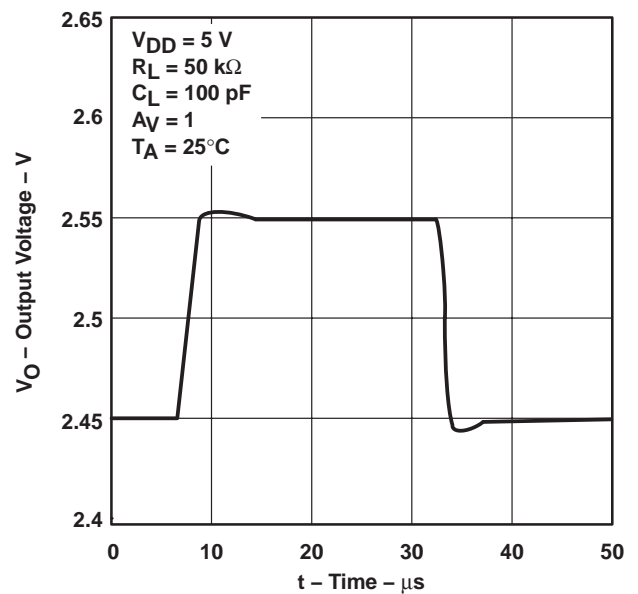
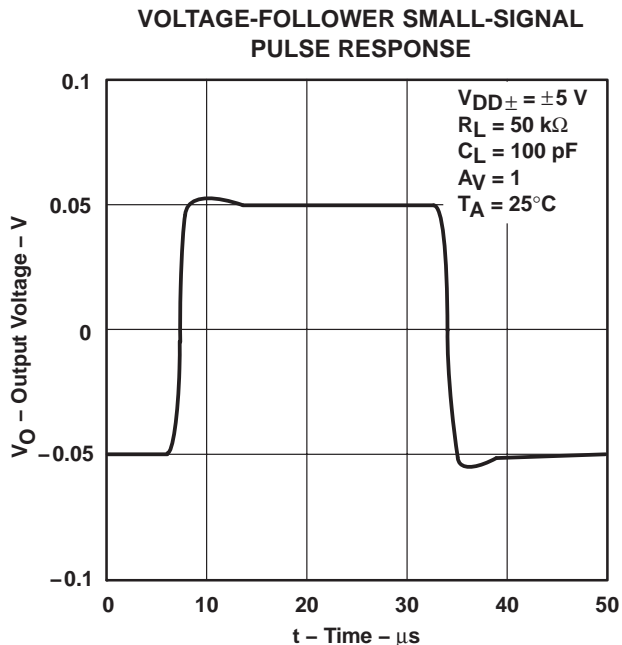


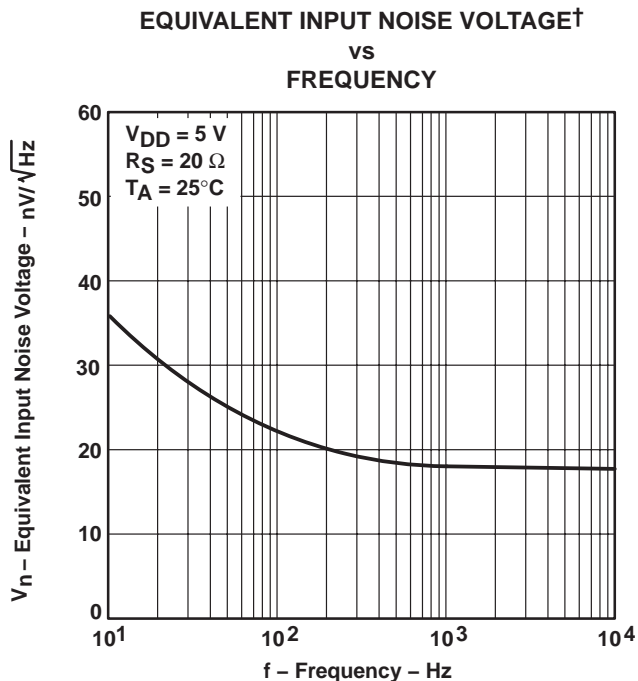
Figure 47

† For curves where  $V_{DD} = 5$  V, all loads are referenced to 2.5 V.

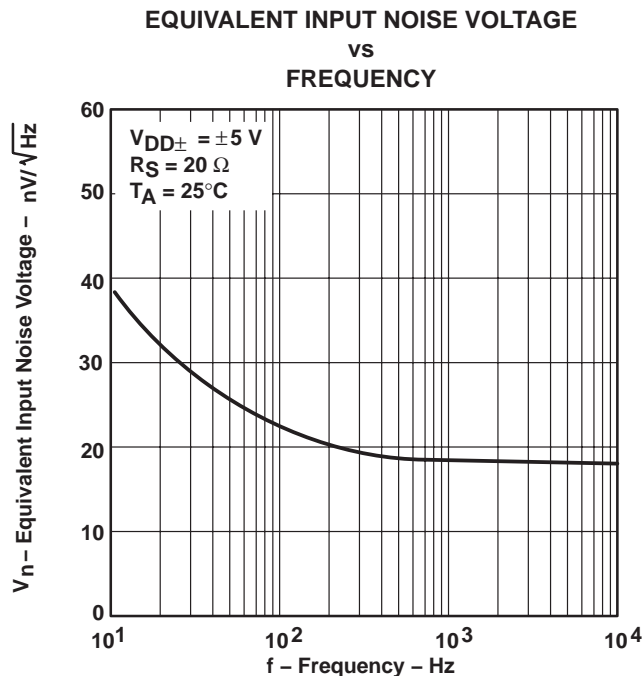
**TYPICAL CHARACTERISTICS**



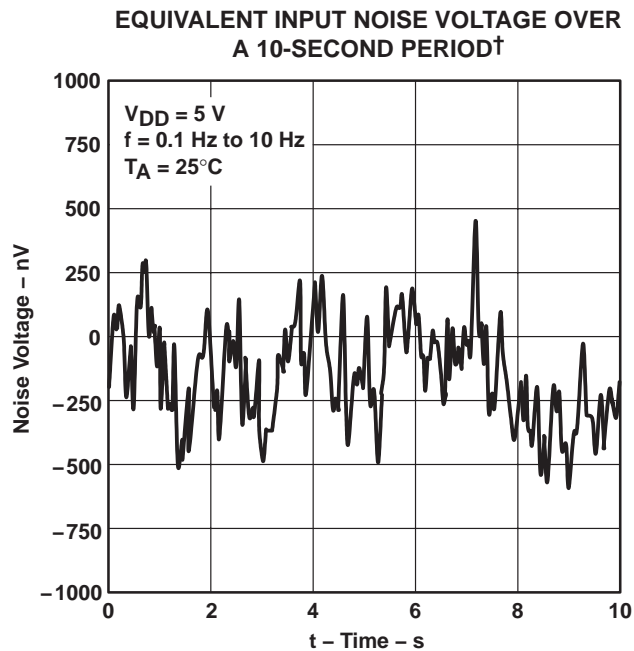
**Figure 48**



**Figure 49**



**Figure 50**



**Figure 51**

† For curves where  $V_{DD} = 5\text{ V}$ , all loads are referenced to  $2.5\text{ V}$ .

TYPICAL CHARACTERISTICS

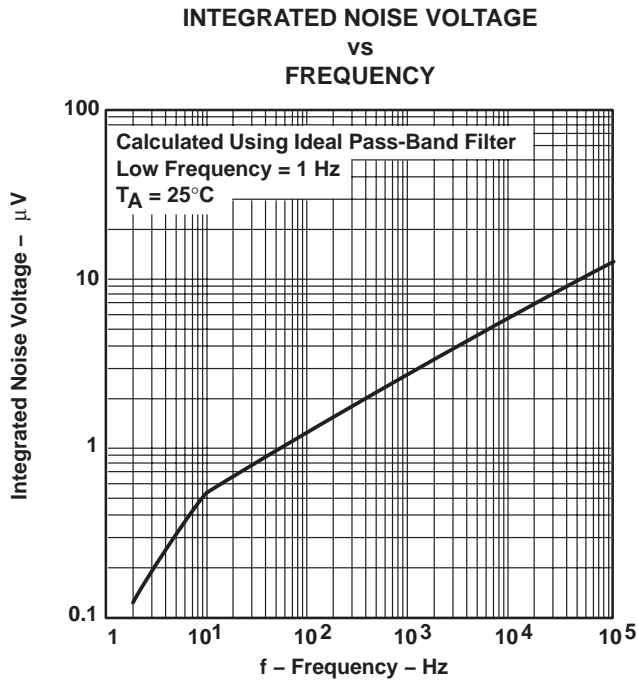


Figure 52

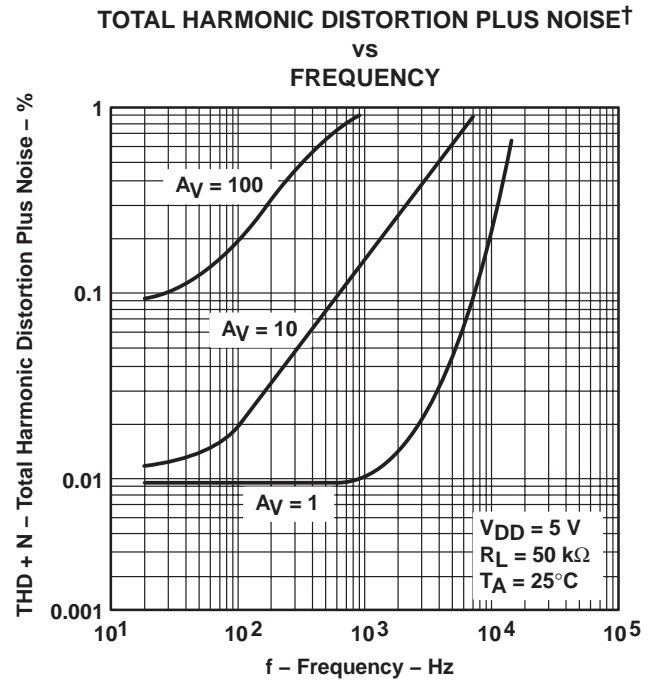


Figure 53

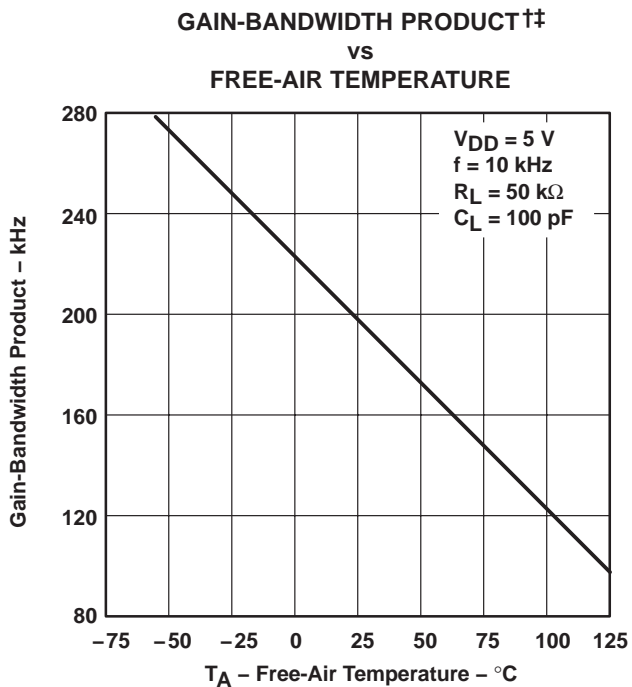


Figure 54

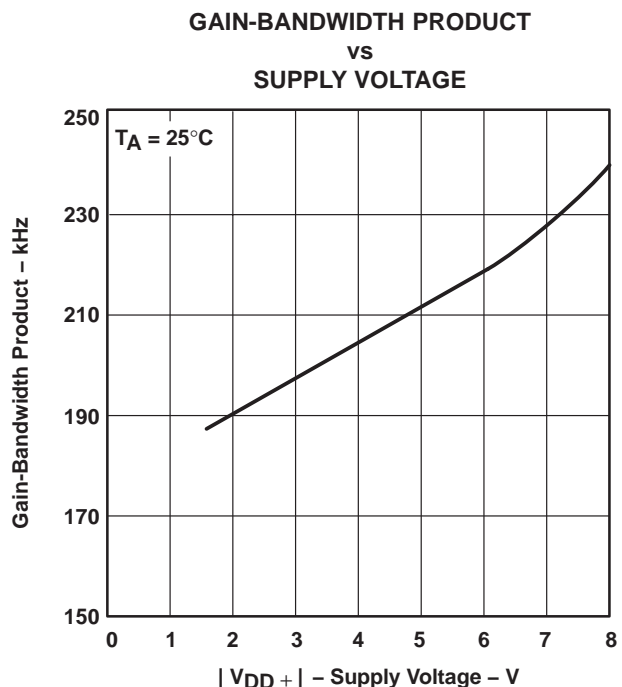
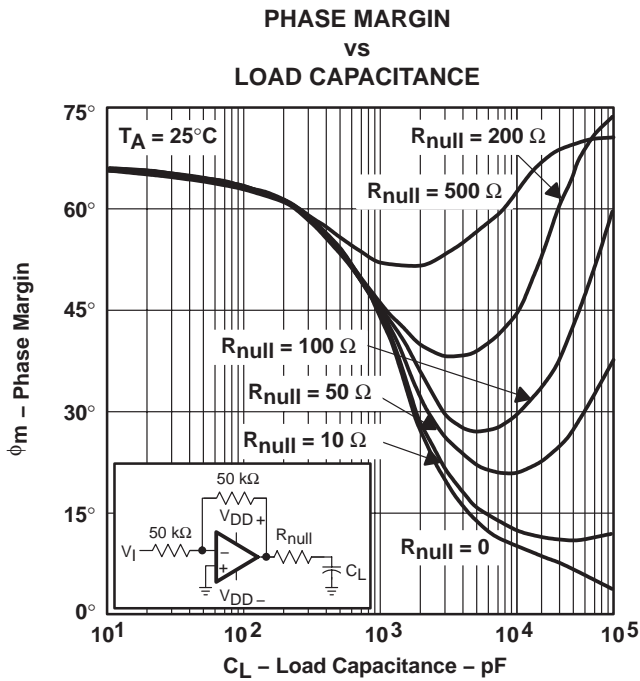


Figure 55

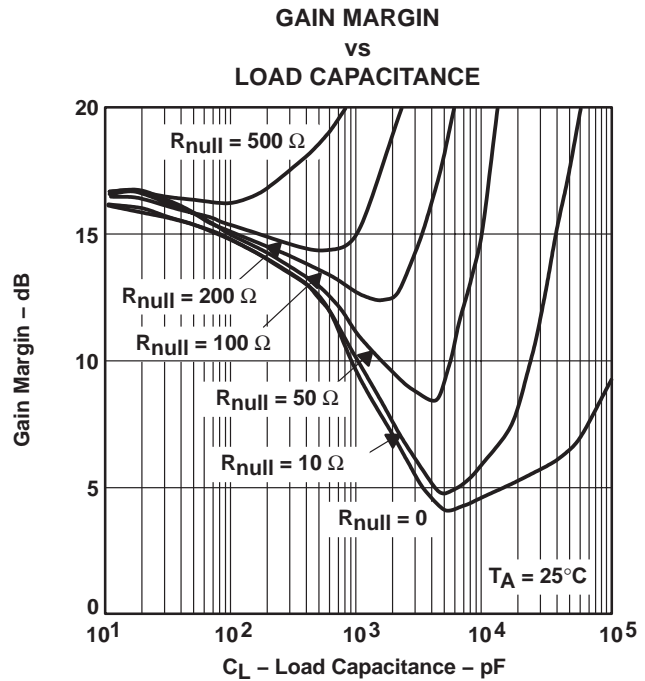
† For curves where  $V_{DD} = 5\text{ V}$ , all loads are referenced to 2.5 V.

†† Data at high and low temperatures are applicable only within the rated operating free-air temperature ranges of the various devices.

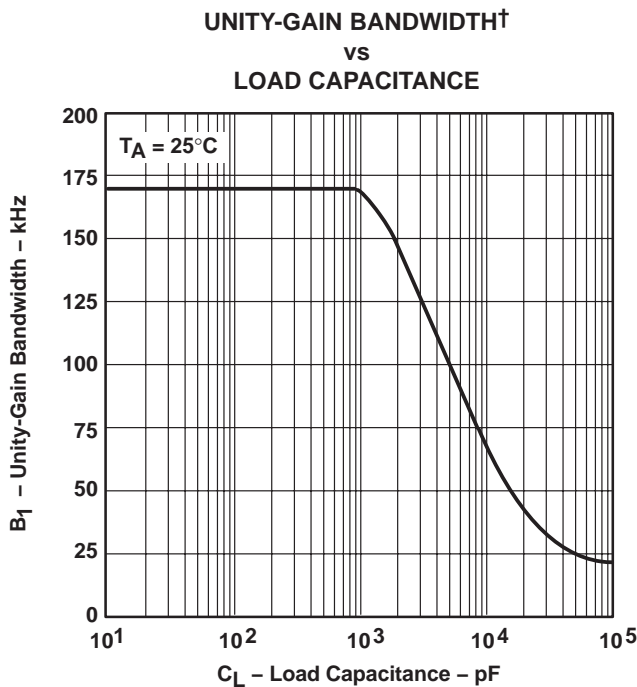
**TYPICAL CHARACTERISTICS**



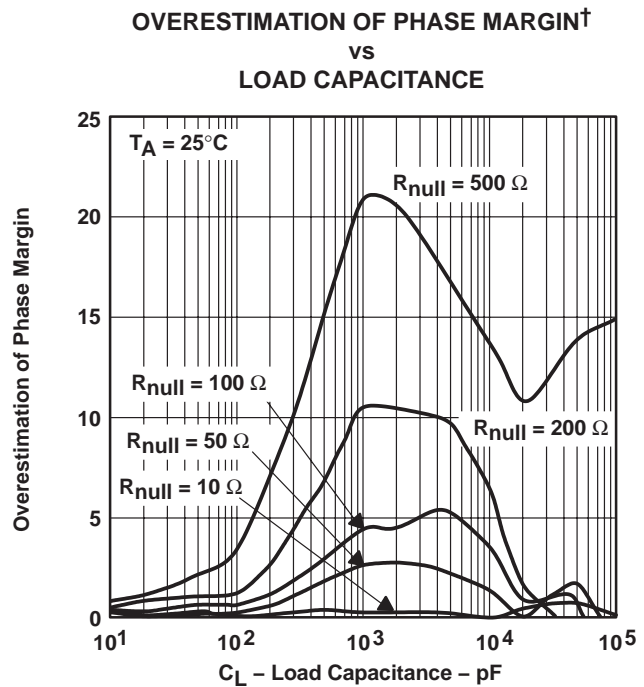
**Figure 56**



**Figure 57**



**Figure 58**



**Figure 59**

† See application information

## APPLICATION INFORMATION

### driving large capacitive loads

The TLC225x is designed to drive larger capacitive loads than most CMOS operational amplifiers. Figure 56 and Figure 57 illustrate its ability to drive loads up to 1000 pF while maintaining good gain and phase margins ( $R_{null} = 0$ ).

A smaller series resistor ( $R_{null}$ ) at the output of the device (see Figure 60) improves the gain and phase margins when driving large capacitive loads. Figure 56 and Figure 57 show the effects of adding series resistances of 10  $\Omega$ , 50  $\Omega$ , 100  $\Omega$ , 200  $\Omega$ , and 500  $\Omega$ . The addition of this series resistor has two effects: the first is that it adds a zero to the transfer function and the second is that it reduces the frequency of the pole associated with the output load in the transfer function.

The zero introduced to the transfer function is equal to the series resistance times the load capacitance. To calculate the improvement in phase margin, equation 1 can be used.

$$\Delta\phi_{m1} = \tan^{-1} \left( 2 \times \pi \times \text{UGBW} \times R_{null} \times C_L \right) \quad (1)$$

Where :

$\Delta\phi_{m1}$  = Improvement in phase margin

UGBW = Unity-gain bandwidth frequency

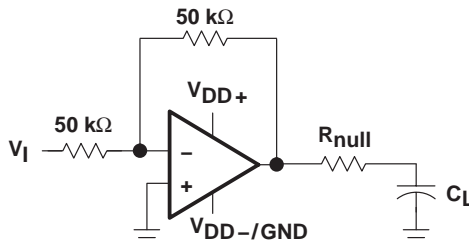
$R_{null}$  = Output series resistance

$C_L$  = Load capacitance

The unity-gain bandwidth (UGBW) frequency decreases as the capacitive load increases (see Figure 58). To use equation 1, UGBW must be approximated from Figure 58.

Using equation 1 alone overestimates the improvement in phase margin, as illustrated in Figure 59. The overestimation is caused by the decrease in the frequency of the pole associated with the load, thus providing additional phase shift and reducing the overall improvement in phase margin.

Using Figure 60, with equation 1 enables the designer to choose the appropriate output series resistance to optimize the design of circuits driving large capacitance loads.



**Figure 60. Series-Resistance Circuit**

**TLC225x-EP, TLC225xA-EP**  
**Advanced LinCMOS™ RAIL-TO-RAIL**  
**VERY LOW-POWER OPERATIONAL AMPLIFIERS**

SGLS216 – NOVEMBER 2003

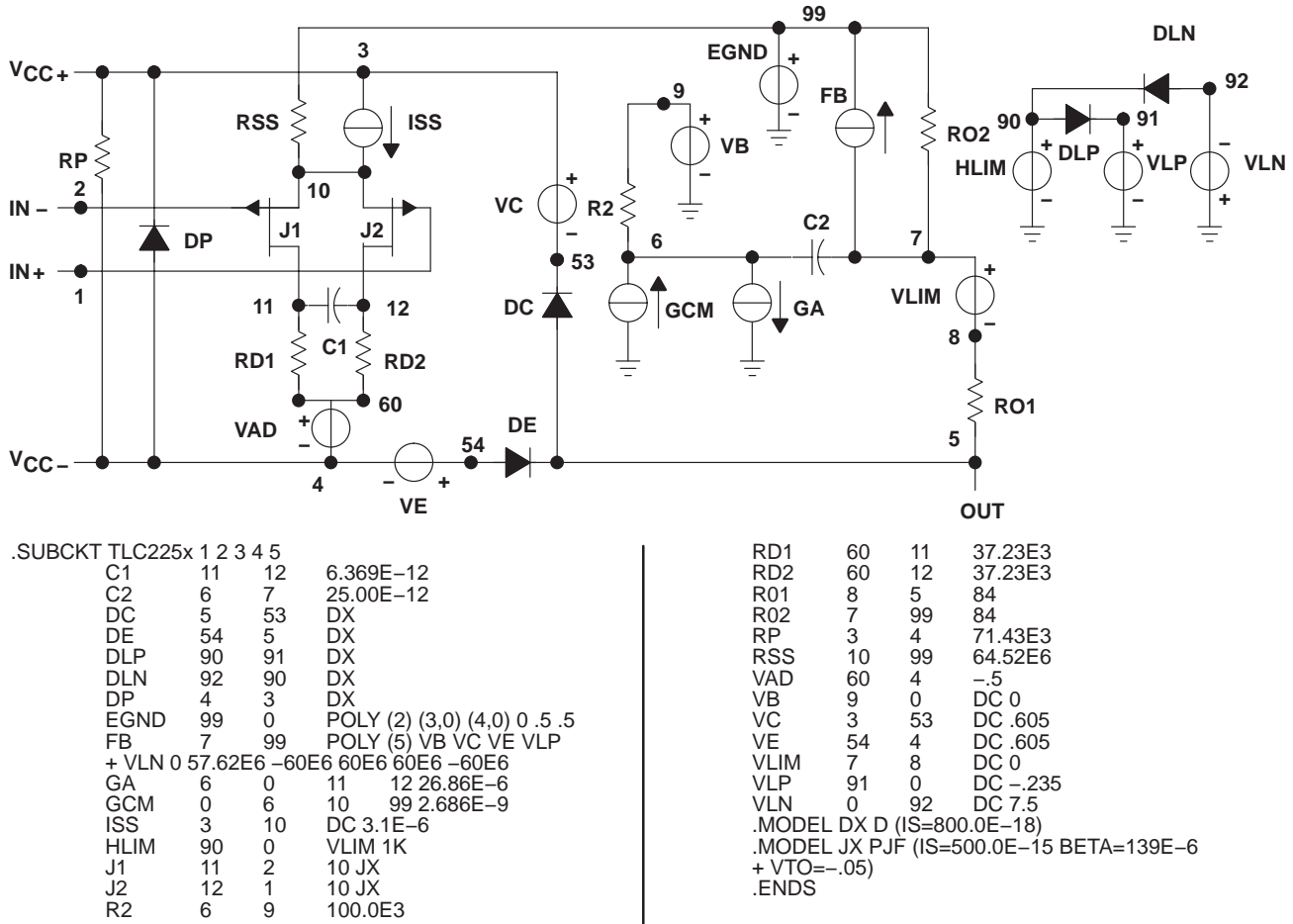
**APPLICATION INFORMATION**

**macromodel information**

Macromodel information provided was derived using MicroSim *Parts*™, the model generation software used with MicroSim *PSpice*™. The Boyle macromodel (see Note 5) and subcircuit in Figure 61 are generated using the TLC225x typical electrical and operating characteristics at  $T_A = 25^\circ\text{C}$ . Using this information, output simulations of the following key parameters can be generated to a tolerance of 20% (in most cases):

- Maximum positive output voltage swing
- Maximum negative output voltage swing
- Slew rate
- Quiescent power dissipation
- Input bias current
- Open-loop voltage amplification
- Unity-gain frequency
- Common-mode rejection ratio
- Phase margin
- DC output resistance
- AC output resistance
- Short-circuit output current limit

NOTE 4: G. R. Boyle, B. M. Cohn, D. O. Pederson, and J. E. Solomon, "Macromodeling of Integrated Circuit Operational Amplifiers", *IEEE Journal of Solid-State Circuits*, SC-9, 353 (1974).



**Figure 61. Boyle Macromodel and Subcircuit**

*PSpice* and *Parts* are trademarks of MicroSim Corporation.



**PACKAGING INFORMATION**

Orderable Device	Status (1)	Package Type	Package Drawing	Pins	Package Qty	Eco Plan (2)	Lead/Ball Finish	MSL Peak Temp (3)	Op Temp (°C)	Top-Side Markings (4)	Samples
TLC2252AQDREP	ACTIVE	SOIC	D	8	2500	Green (RoHS & no Sb/Br)	CU NIPDAU	Level-1-260C-UNLIM	-40 to 125	2252AE	<a href="#">Samples</a>
TLC2252QDREP	ACTIVE	SOIC	D	8	2500	Green (RoHS & no Sb/Br)	CU NIPDAU	Level-1-260C-UNLIM	-40 to 125	2252EP	<a href="#">Samples</a>
TLC2254AQDREP	ACTIVE	SOIC	D	14	2500	Green (RoHS & no Sb/Br)	CU NIPDAU	Level-1-260C-UNLIM	-40 to 125	TLC2254AEP	<a href="#">Samples</a>
TLC2254QDREP	ACTIVE	SOIC	D	14	2500	Green (RoHS & no Sb/Br)	CU NIPDAU	Level-1-260C-UNLIM	-40 to 125	TLC2254EP	<a href="#">Samples</a>
V62/04682-01XE	ACTIVE	SOIC	D	8	2500	Green (RoHS & no Sb/Br)	CU NIPDAU	Level-1-260C-UNLIM	-40 to 125	2252EP	<a href="#">Samples</a>
V62/04682-02XE	ACTIVE	SOIC	D	8	2500	Green (RoHS & no Sb/Br)	CU NIPDAU	Level-1-260C-UNLIM	-40 to 125	2252AE	<a href="#">Samples</a>
V62/04682-03YE	ACTIVE	SOIC	D	14	2500	Green (RoHS & no Sb/Br)	CU NIPDAU	Level-1-260C-UNLIM	-40 to 125	TLC2254EP	<a href="#">Samples</a>
V62/04682-04YE	ACTIVE	SOIC	D	14	2500	Green (RoHS & no Sb/Br)	CU NIPDAU	Level-1-260C-UNLIM	-40 to 125	TLC2254AEP	<a href="#">Samples</a>

(1) The marketing status values are defined as follows:

**ACTIVE:** Product device recommended for new designs.

**LIFEBUY:** TI has announced that the device will be discontinued, and a lifetime-buy period is in effect.

**NRND:** Not recommended for new designs. Device is in production to support existing customers, but TI does not recommend using this part in a new design.

**PREVIEW:** Device has been announced but is not in production. Samples may or may not be available.

**OBSELETE:** TI has discontinued the production of the device.

(2) Eco Plan - The planned eco-friendly classification: Pb-Free (RoHS), Pb-Free (RoHS Exempt), or Green (RoHS & no Sb/Br) - please check <http://www.ti.com/productcontent> for the latest availability information and additional product content details.

**TBD:** The Pb-Free/Green conversion plan has not been defined.

**Pb-Free (RoHS):** TI's terms "Lead-Free" or "Pb-Free" mean semiconductor products that are compatible with the current RoHS requirements for all 6 substances, including the requirement that lead not exceed 0.1% by weight in homogeneous materials. Where designed to be soldered at high temperatures, TI Pb-Free products are suitable for use in specified lead-free processes.

**Pb-Free (RoHS Exempt):** This component has a RoHS exemption for either 1) lead-based flip-chip solder bumps used between the die and package, or 2) lead-based die adhesive used between the die and leadframe. The component is otherwise considered Pb-Free (RoHS compatible) as defined above.

**Green (RoHS & no Sb/Br):** TI defines "Green" to mean Pb-Free (RoHS compatible), and free of Bromine (Br) and Antimony (Sb) based flame retardants (Br or Sb do not exceed 0.1% by weight in homogeneous material)

(3) MSL, Peak Temp. -- The Moisture Sensitivity Level rating according to the JEDEC industry standard classifications, and peak solder temperature.

---

<sup>(4)</sup> Multiple Top-Side Markings will be inside parentheses. Only one Top-Side Marking contained in parentheses and separated by a "-" will appear on a device. If a line is indented then it is a continuation of the previous line and the two combined represent the entire Top-Side Marking for that device.

**Important Information and Disclaimer:**The information provided on this page represents TI's knowledge and belief as of the date that it is provided. TI bases its knowledge and belief on information provided by third parties, and makes no representation or warranty as to the accuracy of such information. Efforts are underway to better integrate information from third parties. TI has taken and continues to take reasonable steps to provide representative and accurate information but may not have conducted destructive testing or chemical analysis on incoming materials and chemicals. TI and TI suppliers consider certain information to be proprietary, and thus CAS numbers and other limited information may not be available for release.

In no event shall TI's liability arising out of such information exceed the total purchase price of the TI part(s) at issue in this document sold by TI to Customer on an annual basis.

**OTHER QUALIFIED VERSIONS OF TLC2252-EP, TLC2252A-EP, TLC2254-EP, TLC2254A-EP :**

- Catalog: [TLC2252](#), [TLC2252A](#), [TLC2254](#), [TLC2254A](#)
  
- Automotive: [TLC2252-Q1](#), [TLC2252A-Q1](#), [TLC2254-Q1](#), [TLC2254A-Q1](#)
  
- Military: [TLC2252M](#), [TLC2252AM](#), [TLC2254M](#), [TLC2254AM](#)

NOTE: Qualified Version Definitions:

- Catalog - TI's standard catalog product
  
- Automotive - Q100 devices qualified for high-reliability automotive applications targeting zero defects
  
- Military - QML certified for Military and Defense Applications



**TAPE AND REEL INFORMATION**

**QUADRANT ASSIGNMENTS FOR PIN 1 ORIENTATION IN TAPE**


\*All dimensions are nominal

Device	Package Type	Package Drawing	Pins	SPQ	Reel Diameter (mm)	Reel Width W1 (mm)	A0 (mm)	B0 (mm)	K0 (mm)	P1 (mm)	W (mm)	Pin1 Quadrant
TLC2252AQDREP	SOIC	D	8	2500	330.0	12.4	6.4	5.2	2.1	8.0	12.0	Q1
TLC2252QDREP	SOIC	D	8	2500	330.0	12.4	6.4	5.2	2.1	8.0	12.0	Q1
TLC2254AQDREP	SOIC	D	14	2500	330.0	16.4	6.5	9.0	2.1	8.0	16.0	Q1
TLC2254QDREP	SOIC	D	14	2500	330.0	16.4	6.5	9.0	2.1	8.0	16.0	Q1

**TAPE AND REEL BOX DIMENSIONS**


\*All dimensions are nominal

Device	Package Type	Package Drawing	Pins	SPQ	Length (mm)	Width (mm)	Height (mm)
TLC2252AQDREP	SOIC	D	8	2500	367.0	367.0	35.0
TLC2252QDREP	SOIC	D	8	2500	367.0	367.0	35.0
TLC2254AQDREP	SOIC	D	14	2500	333.2	345.9	28.6
TLC2254QDREP	SOIC	D	14	2500	333.2	345.9	28.6

D (R-PDSO-G14)

PLASTIC SMALL OUTLINE



- NOTES:
- A. All linear dimensions are in inches (millimeters).
  - B. This drawing is subject to change without notice.
  -  Body length does not include mold flash, protrusions, or gate burrs. Mold flash, protrusions, or gate burrs shall not exceed 0.006 (0,15) each side.
  -  Body width does not include interlead flash. Interlead flash shall not exceed 0.017 (0,43) each side.
  - E. Reference JEDEC MS-012 variation AB.

D (R-PDSO-G14)

PLASTIC SMALL OUTLINE



4211283-3/E 08/12

- NOTES:
- All linear dimensions are in millimeters.
  - This drawing is subject to change without notice.
  - Publication IPC-7351 is recommended for alternate designs.
  - Laser cutting apertures with trapezoidal walls and also rounding corners will offer better paste release. Customers should contact their board assembly site for stencil design recommendations. Refer to IPC-7525 for other stencil recommendations.
  - Customers should contact their board fabrication site for solder mask tolerances between and around signal pads.

D (R-PDSO-G8)

PLASTIC SMALL OUTLINE



4040047-3/M 06/11

D (R-PDSO-G8)

PLASTIC SMALL OUTLINE



- NOTES:
- All linear dimensions are in millimeters.
  - This drawing is subject to change without notice.
  - Publication IPC-7351 is recommended for alternate designs.
  - Laser cutting apertures with trapezoidal walls and also rounding corners will offer better paste release. Customers should contact their board assembly site for stencil design recommendations. Refer to IPC-7525 for other stencil recommendations.
  - Customers should contact their board fabrication site for solder mask tolerances between and around signal pads.

## IMPORTANT NOTICE

Texas Instruments Incorporated and its subsidiaries (TI) reserve the right to make corrections, enhancements, improvements and other changes to its semiconductor products and services per JESD46, latest issue, and to discontinue any product or service per JESD48, latest issue. Buyers should obtain the latest relevant information before placing orders and should verify that such information is current and complete. All semiconductor products (also referred to herein as "components") are sold subject to TI's terms and conditions of sale supplied at the time of order acknowledgment.

TI warrants performance of its components to the specifications applicable at the time of sale, in accordance with the warranty in TI's terms and conditions of sale of semiconductor products. Testing and other quality control techniques are used to the extent TI deems necessary to support this warranty. Except where mandated by applicable law, testing of all parameters of each component is not necessarily performed.

TI assumes no liability for applications assistance or the design of Buyers' products. Buyers are responsible for their products and applications using TI components. To minimize the risks associated with Buyers' products and applications, Buyers should provide adequate design and operating safeguards.

TI does not warrant or represent that any license, either express or implied, is granted under any patent right, copyright, mask work right, or other intellectual property right relating to any combination, machine, or process in which TI components or services are used. Information published by TI regarding third-party products or services does not constitute a license to use such products or services or a warranty or endorsement thereof. Use of such information may require a license from a third party under the patents or other intellectual property of the third party, or a license from TI under the patents or other intellectual property of TI.

Reproduction of significant portions of TI information in TI data books or data sheets is permissible only if reproduction is without alteration and is accompanied by all associated warranties, conditions, limitations, and notices. TI is not responsible or liable for such altered documentation. Information of third parties may be subject to additional restrictions.

Resale of TI components or services with statements different from or beyond the parameters stated by TI for that component or service voids all express and any implied warranties for the associated TI component or service and is an unfair and deceptive business practice. TI is not responsible or liable for any such statements.

Buyer acknowledges and agrees that it is solely responsible for compliance with all legal, regulatory and safety-related requirements concerning its products, and any use of TI components in its applications, notwithstanding any applications-related information or support that may be provided by TI. Buyer represents and agrees that it has all the necessary expertise to create and implement safeguards which anticipate dangerous consequences of failures, monitor failures and their consequences, lessen the likelihood of failures that might cause harm and take appropriate remedial actions. Buyer will fully indemnify TI and its representatives against any damages arising out of the use of any TI components in safety-critical applications.

In some cases, TI components may be promoted specifically to facilitate safety-related applications. With such components, TI's goal is to help enable customers to design and create their own end-product solutions that meet applicable functional safety standards and requirements. Nonetheless, such components are subject to these terms.

No TI components are authorized for use in FDA Class III (or similar life-critical medical equipment) unless authorized officers of the parties have executed a special agreement specifically governing such use.

Only those TI components which TI has specifically designated as military grade or "enhanced plastic" are designed and intended for use in military/aerospace applications or environments. Buyer acknowledges and agrees that any military or aerospace use of TI components which have **not** been so designated is solely at the Buyer's risk, and that Buyer is solely responsible for compliance with all legal and regulatory requirements in connection with such use.

TI has specifically designated certain components as meeting ISO/TS16949 requirements, mainly for automotive use. In any case of use of non-designated products, TI will not be responsible for any failure to meet ISO/TS16949.

### Products

Audio	<a href="http://www.ti.com/audio">www.ti.com/audio</a>
Amplifiers	<a href="http://amplifier.ti.com">amplifier.ti.com</a>
Data Converters	<a href="http://dataconverter.ti.com">dataconverter.ti.com</a>
DLP® Products	<a href="http://www.dlp.com">www.dlp.com</a>
DSP	<a href="http://dsp.ti.com">dsp.ti.com</a>
Clocks and Timers	<a href="http://www.ti.com/clocks">www.ti.com/clocks</a>
Interface	<a href="http://interface.ti.com">interface.ti.com</a>
Logic	<a href="http://logic.ti.com">logic.ti.com</a>
Power Mgmt	<a href="http://power.ti.com">power.ti.com</a>
Microcontrollers	<a href="http://microcontroller.ti.com">microcontroller.ti.com</a>
RFID	<a href="http://www.ti-rfid.com">www.ti-rfid.com</a>
OMAP Applications Processors	<a href="http://www.ti.com/omap">www.ti.com/omap</a>
Wireless Connectivity	<a href="http://www.ti.com/wirelessconnectivity">www.ti.com/wirelessconnectivity</a>

### Applications

Automotive and Transportation	<a href="http://www.ti.com/automotive">www.ti.com/automotive</a>
Communications and Telecom	<a href="http://www.ti.com/communications">www.ti.com/communications</a>
Computers and Peripherals	<a href="http://www.ti.com/computers">www.ti.com/computers</a>
Consumer Electronics	<a href="http://www.ti.com/consumer-apps">www.ti.com/consumer-apps</a>
Energy and Lighting	<a href="http://www.ti.com/energy">www.ti.com/energy</a>
Industrial	<a href="http://www.ti.com/industrial">www.ti.com/industrial</a>
Medical	<a href="http://www.ti.com/medical">www.ti.com/medical</a>
Security	<a href="http://www.ti.com/security">www.ti.com/security</a>
Space, Avionics and Defense	<a href="http://www.ti.com/space-avionics-defense">www.ti.com/space-avionics-defense</a>
Video and Imaging	<a href="http://www.ti.com/video">www.ti.com/video</a>

### TI E2E Community

[e2e.ti.com](http://e2e.ti.com)