

# TLV2470, TLV2471, TLV2472, TLV2473, TLV2474, TLV2475, TLV247xA FAMILY OF 600- $\mu$ A/Ch 2.8-MHz RAIL-TO-RAIL INPUT/OUTPUT HIGH-DRIVE OPERATIONAL AMPLIFIERS WITH SHUTDOWN

SLOS232C - JUNE 1999 - REVISED DECEMBER 2003

- CMOS Rail-To-Rail Input/Output
- Input Bias Current . . . 2.5 pA
- Low Supply Current . . . 600  $\mu$ A/Channel
- Ultra-Low Power Shutdown Mode
  - $I_{DD}(SHDN)$  . . . 350 nA/ch at 3 V
  - $I_{DD}(SHDN)$  . . . 1000 nA/ch at 5 V
- Gain-Bandwidth Product . . . 2.8 MHz
- High Output Drive Capability
  - $\pm 10$  mA at 180 mV
  - $\pm 35$  mA at 500 mV
- Input Offset Voltage . . . 250  $\mu$ V (typ)
- Supply Voltage Range . . . 2.7 V to 6 V
- Ultra Small Packaging
  - 5 or 6 Pin SOT-23 (TLV2470/1)
  - 8 or 10 Pin MSOP (TLV2472/3)

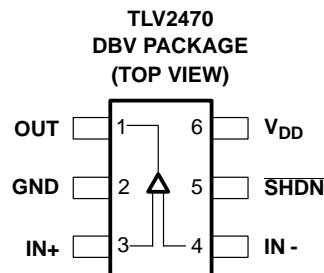

## description

The TLV247x is a family of CMOS rail-to-rail input/output operational amplifiers that establishes a new performance point for supply current versus ac performance. These devices consume just 600  $\mu$ A/channel while offering 2.8 MHz of gain-bandwidth product. Along with increased ac performance, the amplifier provides high output drive capability, solving a major shortcoming of older micropower operational amplifiers. The TLV247x can swing to within 180 mV of each supply rail while driving a 10-mA load. For non-RRO applications, the TLV247x can supply  $\pm 35$  mA at 500 mV off the rail. Both the inputs and outputs swing rail-to-rail for increased dynamic range in low-voltage applications. This performance makes the TLV247x family ideal for sensor interface, portable medical equipment, and other data acquisition circuits.

FAMILY PACKAGE TABLE

DEVICE	NUMBER OF CHANNELS	PACKAGE TYPES					SHUTDOWN	UNIVERSAL EVM BOARD
		PDIP	SOIC	SOT-23	TSSOP	MSOP		
TLV2470	1	8	8	6	—	—	Yes	Refer to the EVM Selection Guide (Lit# SLOU060)
TLV2471	1	8	8	5	—	—	—	
TLV2472	2	8	8	—	—	8	—	
TLV2473	2	14	14	—	—	10	Yes	
TLV2474	4	14	14	—	14	—	—	
TLV2475	4	16	16	—	16	—	Yes	

A SELECTION OF SINGLE-SUPPLY OPERATIONAL AMPLIFIER PRODUCTS<sup>†</sup>

DEVICE	$V_{DD}$ (V)	$V_{IO}$ ( $\mu$ V)	BW (MHz)	SLEW RATE (V/ $\mu$ s)	$I_{DD}$ (per channel) ( $\mu$ A)	OUTPUT DRIVE	RAIL-TO-RAIL
TLV247X	2.7 - 6.0	250	2.8	1.5	600	$\pm 35$ mA	I/O
TLV245X	2.7 - 6.0	20	0.22	0.11	23	$\pm 10$ mA	I/O
TLV246X	2.7 - 6.0	150	6.4	1.6	550	$\pm 90$ mA	I/O
TLV277X	2.5 - 6.0	360	5.1	10.5	1000	$\pm 10$ mA	O

<sup>†</sup> All specifications measured at 5 V.



Please be aware that an important notice concerning availability, standard warranty, and use in critical applications of Texas Instruments semiconductor products and disclaimers thereto appears at the end of this data sheet.

PRODUCTION DATA information is current as of publication date. Products conform to specifications per the terms of Texas Instruments standard warranty. Production processing does not necessarily include testing of all parameters.

 **TEXAS  
INSTRUMENTS**

POST OFFICE BOX 655303 • DALLAS, TEXAS 75265

Copyright © 1999-2003, Texas Instruments Incorporated

**TLV2470, TLV2471, TLV2472, TLV2473, TLV2474, TLV2475, TLV247xA**  
**FAMILY OF 600- $\mu$ A/Ch 2.8-MHz RAIL-TO-RAIL INPUT/OUTPUT**  
**HIGH-DRIVE OPERATIONAL AMPLIFIERS WITH SHUTDOWN**

SLOS232C - JUNE 1999 - REVISED AUGUST 2003

**TLV2470 and TLV2471 AVAILABLE OPTIONS**

T <sub>A</sub>	PACKAGED DEVICES			
	SMALL OUTLINE (D) <sup>†</sup>	SOT-23		PLASTIC DIP (P)
		(DBV) <sup>†</sup>	SYMBOL	
0°C to 70°C	TLV2470CD TLV2471CD	TLV2470CDBV TLV2471CDBV	VAUC VAVC	TLV2470CP TLV2471CP
- 40°C to 125°C	TLV2470ID TLV2471ID	TLV2470IDBV TLV2471IDBV	VAUI VAVI	TLV2470IP TLV2471IP
	TLV2470AID TLV2471AID	— —	— —	TLV2470AIP TLV2471AIP

<sup>†</sup> This package is available taped and reeled. To order this packaging option, add an R suffix to the part number (e.g., TLV2470CDR).

**TLV2472 AND TLV2473 AVAILABLE OPTIONS**

T <sub>A</sub>	PACKAGED DEVICES						
	SMALL OUTLINE (D) <sup>†</sup>	MSOP		MSOP		PLASTIC DIP (N)	PLASTIC DIP (P)
		(DGN) <sup>†</sup>	SYMBOL <sup>‡</sup>	(DGQ) <sup>†</sup>	SYMBOL <sup>‡</sup>		
0°C to 70°C	TLV2472CD TLV2473CD	TLV2472CDGN —	xxTIABU —	— TLV2473CDGQ	— xxTIABW	— TLV2473CN	TLV2472CP —
- 40°C to 125°C	TLV2472ID TLV2473ID	TLV2472IDGN —	xxTIABV —	— TLV2473IDGQ	— xxTIABX	— TLV2473IN	TLV2472IP —
	TLV2472AID TLV2473AID	— —	— —	— —	— —	— TLV2473AIN	TLV2472AIP —

<sup>†</sup> This package is available taped and reeled. To order this packaging option, add an R suffix to the part number (e.g., TLV2472CDR).

<sup>‡</sup> xx represents the device date code.

**TLV2474 and TLV2475 AVAILABLE OPTIONS**

T <sub>A</sub>	PACKAGED DEVICES		
	SMALL OUTLINE (D) <sup>†</sup>	PLASTIC DIP (N)	TSSOP (PWP) <sup>†</sup>
0°C to 70°C	TLV2474CD TLV2475CD	TLV2474CN TLV2475CN	TLV2474CPWP TLV2475CPWP
- 40°C to 125°C	TLV2474ID TLV2475ID	TLV2474IN TLV2475IN	TLV2474IPWP TLV2475IPWP
	TLV2474AID TLV2475AID	TLV2474AIN TLV2475AIN	TLV2474AIPWP TLV2475AIPWP

<sup>†</sup> This package is available taped and reeled. To order this packaging option, add an R suffix to the part number (e.g., TLV2474CDR).



# TLV2470, TLV2471, TLV2472, TLV2473, TLV2474, TLV2475, TLV247xA FAMILY OF 600- $\mu$ A/Ch 2.8-MHz RAIL-TO-RAIL INPUT/OUTPUT HIGH-DRIVE OPERATIONAL AMPLIFIERS WITH SHUTDOWN

SLOS232C - JUNE 1999 - REVISED AUGUST 2003

## TLV247x PACKAGE PINOUTS<sup>(1)</sup>

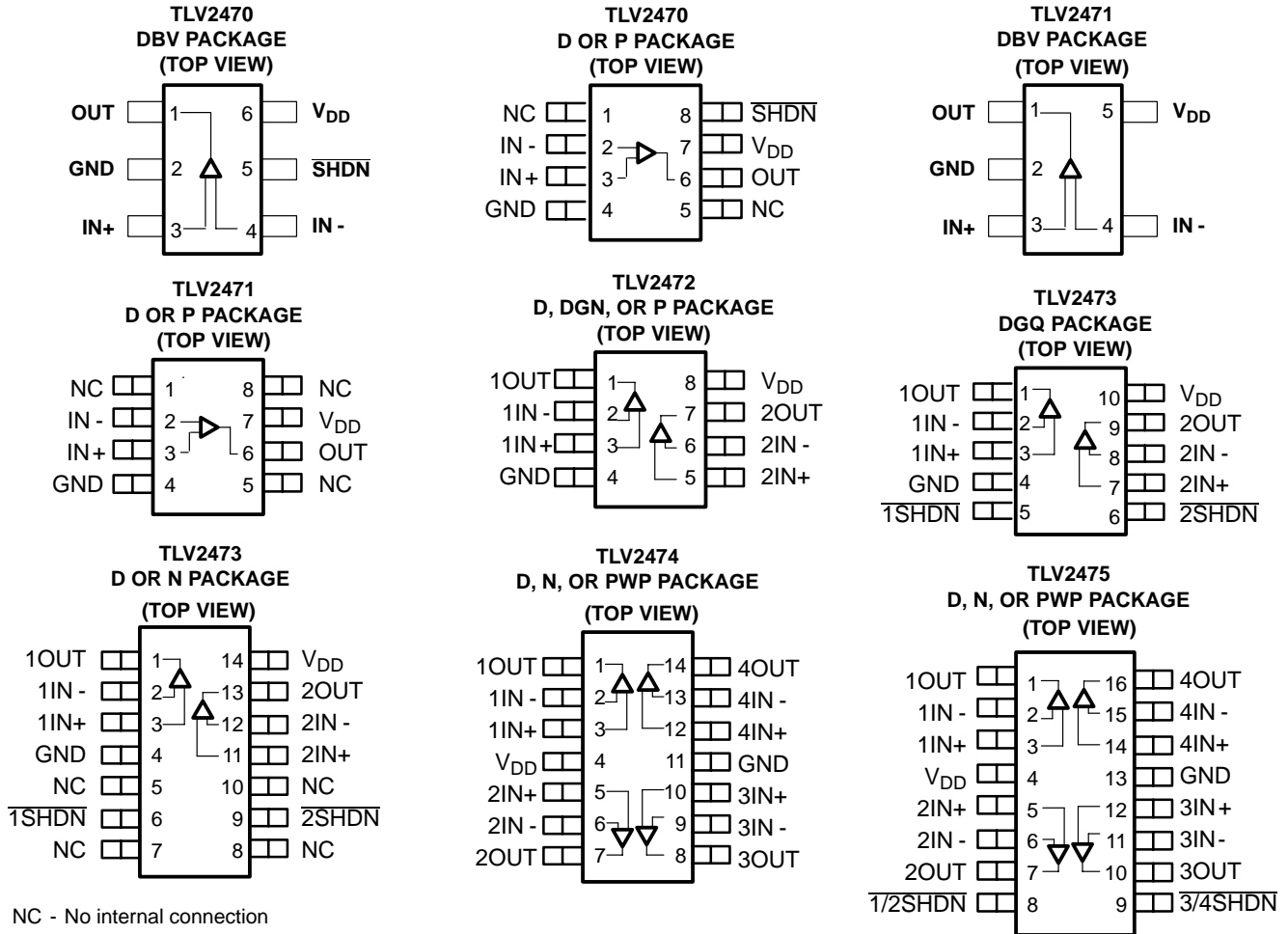

## TYPICAL PIN 1 INDICATORS

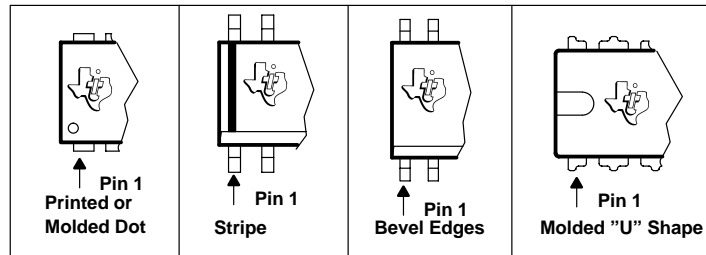

# TLV2470, TLV2471, TLV2472, TLV2473, TLV2474, TLV2475, TLV247xA FAMILY OF 600- $\mu$ A/Ch 2.8-MHz RAIL-TO-RAIL INPUT/OUTPUT HIGH-DRIVE OPERATIONAL AMPLIFIERS WITH SHUTDOWN

SLOS232C - JUNE 1999 - REVISED AUGUST 2003

## description (continued)

Three members of the family (TLV2470/3/5) offer a shutdown terminal for conserving battery life in portable applications. During shutdown, the outputs are placed in a high-impedance state and the amplifier consumes only 350 nA/channel. The family is fully specified at 3 V and 5 V across an expanded industrial temperature range (-40°C to 125°C). The singles and duals are available in the SOT23 and MSOP packages, while the quads are available in TSSOP. The TLV2470 offers an amplifier with shutdown functionality all in a 6-pin SOT23 package, making it perfect for high density power-sensitive circuits.

## absolute maximum ratings over operating free-air temperature range (unless otherwise noted)<sup>†</sup>

Supply voltage, $V_{DD}$ (see Note 1)	7 V
Differential input voltage, $V_{ID}$	$\pm V_{DD}$
Continuous total power dissipation	See Dissipation Rating Table
Operating free-air temperature range, $T_A$ : C suffix	0°C to 70°C
I suffix	-40°C to 125°C
Maximum junction temperature, $T_J$	150°C
Storage temperature range, $T_{stg}$	-65°C to 150°C
Lead temperature 1,6 mm (1/16 inch) from case for 10 seconds	260°C

<sup>†</sup> Stresses beyond those listed under “absolute maximum ratings” may cause permanent damage to the device. These are stress ratings only, and functional operation of the device at these or any other conditions beyond those indicated under “recommended operating conditions” is not implied. Exposure to absolute-maximum-rated conditions for extended periods may affect device reliability.

NOTE: All voltage values, except differential voltages, are with respect to GND.

DISSIPATION RATING TABLE

PACKAGE	$\theta_{JC}$ (°C/W)	$\theta_{JA}$ (°C/W)	$T_A \leq 25^\circ\text{C}$ POWER RATING
D (8)	38.3	176	710 mW
D (14)	26.9	122.3	1022 mW
D (16)	25.7	114.7	1090 mW
DBV (5)	55	324.1	385 mW
DBV (6)	55	294.3	425 mW
DGN (8)	4.7	52.7	2.37 W
DGQ (10)	4.7	52.3	2.39 W
N (14, 16)	32	78	1600 mW
P (8)	41	104	1200 mW
PWP (14)	2.07	30.7	4.07 W
PWP (16)	2.07	29.7	4.21 W

## recommended operating conditions

		MIN	MAX	UNIT
Supply voltage, $V_{DD}$	Single supply	2.7	6	V
	Split supply	$\pm 1.35$	$\pm 3$	
Common-mode input voltage range, $V_{ICR}$		0	$V_{DD}$	V
Operating free-air temperature, $T_A$	C-suffix	0	70	°C
	I-suffix	-40	125	
Shutdown on/off voltage level <sup>‡</sup>	$V_{IH}$	2		V
	$V_{IL}$		0.8	

<sup>‡</sup> Relative to GND



**TLV2470, TLV2471, TLV2472, TLV2473, TLV2474, TLV2475, TLV247xA**  
**FAMILY OF 600- $\mu$ A/Ch 2.8-MHz RAIL-TO-RAIL INPUT/OUTPUT**  
**HIGH-DRIVE OPERATIONAL AMPLIFIERS WITH SHUTDOWN**

SLOS232C - JUNE 1999 - REVISED AUGUST 2003

**electrical characteristics at specified free-air temperature,  $V_{DD} = 3\text{ V}$  (unless otherwise noted)**

PARAMETER	TEST CONDITIONS	$T_A^\dagger$	MIN	TYP	MAX	UNIT
$V_{IO}$ Input offset voltage		TLV247x	25°C	250	2200	$\mu\text{V}$
			Full range		2400	
		TLV247xA	25°C	250	1600	
			Full range		1800	
$\alpha_{VIO}$ Temperature coefficient of input offset voltage	$V_{IC} = V_{DD}/2$ , $V_O = V_{DD}/2$ , $R_S = 50\ \Omega$			0.4		$\mu\text{V}/^\circ\text{C}$
		25°C	1.5	50		
$I_{IO}$ Input offset current		TLV247xC	Full range		100	$\text{pA}$
		TLV247xl	Full range		300	
$I_{IB}$ Input bias current			25°C	2	50	
		TLV247xC	Full range		100	
		TLV247xl	Full range		300	
$V_{OH}$ High-level output voltage	$V_{IC} = V_{DD}/2$	$I_{OH} = -2.5\text{ mA}$	25°C	2.85	2.94	$\text{V}$
			Full range		2.8	
		$I_{OH} = -10\text{ mA}$	25°C	2.6	2.74	
			Full range		2.5	
$V_{OL}$ Low-level output voltage	$V_{IC} = V_{DD}/2$	$I_{OL} = 2.5\text{ mA}$	25°C	0.07	0.15	$\text{V}$
			Full range		0.2	
		$I_{OL} = 10\text{ mA}$	25°C	0.2	0.35	
			Full range		0.5	
$I_{OS}$ Short-circuit output current	Sourcing		25°C	30	$\text{mA}$	
			Full range	20		
	Sourcing, Outside of rails $\ddagger$	TLV247xC	Full range	60		
		TLV247xl	Full range	59		
	Sinking		25°C	30		
			Full range	20		
	Sinking, Outside of rails $\ddagger$		25°C	62		
		TLV247xC	Full range	60		
		TLV247xl	Full range	59		
$I_O$ Output current	$V_O = 0.5\text{ V}$ from rail		25°C	$\pm 22$	$\text{mA}$	
$A_{VD}$ Large-signal differential voltage amplification	$V_{O(PP)} = 1\text{ V}$ , $R_L = 10\text{ k}\Omega$		25°C	90	116	$\text{dB}$
			Full range	88		
$r_{i(d)}$ Differential input resistance			25°C	$10^{12}$	$\Omega$	
$C_{IC}$ Common-mode input capacitance	$f = 10\text{ kHz}$		25°C	19.3	$\text{pF}$	
$z_o$ Closed-loop output impedance	$f = 10\text{ kHz}$ , $A_V = 10$		25°C	2	$\Omega$	

$\dagger$  Full range is 0°C to 70°C for C suffix and -40°C to 125°C for l suffix. If not specified, full range is -40°C to 125°C.

$\ddagger$  Depending on package dissipation rating



**TLV2470, TLV2471, TLV2472, TLV2473, TLV2474, TLV2475, TLV247xA**  
**FAMILY OF 600- $\mu$ A/Ch 2.8-MHz RAIL-TO-RAIL INPUT/OUTPUT**  
**HIGH-DRIVE OPERATIONAL AMPLIFIERS WITH SHUTDOWN**

SLOS232C - JUNE 1999 - REVISED AUGUST 2003

**electrical characteristics at specified free-air temperature,  $V_{DD} = 3$  V (unless otherwise noted) (continued)**

PARAMETER		TEST CONDITIONS		$T_A^\dagger$	MIN	TYP	MAX	UNIT
CMRR	Common-mode rejection ratio	$V_{IC} = 0$ to 3 V, $R_S = 50 \Omega$		25°C	61	78		dB
				TLV247xC	Full range	59		
				TLV247xI	Full range	58		
$k_{SVR}$	Supply voltage rejection ratio ( $\Delta V_{DD} / \Delta V_{IO}$ )	$V_{DD} = 2.7$ V to 6 V, No load	$V_{IC} = V_{DD}/2$ ,	25°C	74	90		dB
				Full range	66			
				25°C	77	92		
				Full range	68			
$I_{DD}$	Supply current (per channel)	$V_O = 1.5$ V,	No load	25°C		550	750	$\mu$ A
				Full range			800	
$I_{DD(SHDN)}$	Supply current in shutdown mode (TLV2470, TLV2473, TLV2475) (per channel)	SHDN = 0 V		25°C		350	1500	nA
				TLV247xC	Full range		2000	
				TLV247xI	Full range		4000	

$^\dagger$  Full range is 0°C to 70°C for C suffix and -40°C to 125°C for I suffix. If not specified, full range is -40°C to 125°C.

**operating characteristics at specified free-air temperature,  $V_{DD} = 3$  V (unless otherwise noted)**

PARAMETER		TEST CONDITIONS		$T_A^\dagger$	MIN	TYP	MAX	UNIT
SR	Slew rate at unity gain	$V_{O(PP)} = 0.8$ V, $R_L = 10$ k $\Omega$	$C_L = 150$ pF,	25°C	1.1	1.4		V/ $\mu$ s
				Full range	0.6			
$V_n$	Equivalent input noise voltage			25°C		28		nV/ $\sqrt{Hz}$
				25°C		15		
$I_n$	Equivalent input noise current			25°C		0.405		pA/ $\sqrt{Hz}$
THD + N	Total harmonic distortion plus noise	$V_{O(PP)} = 2$ V, $R_L = 10$ k $\Omega$ , f = 1 kHz		25°C		$A_V = 1$	0.02%	
						$A_V = 10$	0.1%	
						$A_V = 100$	0.5%	
$t_{(on)}$	Amplifier turnon time	$R_L = OPEN^\ddagger$		25°C		5		$\mu$ s
$t_{(off)}$	Amplifier turnoff time			25°C		250		ns
	Gain-bandwidth product	f = 10 kHz,	$R_L = 600 \Omega$	25°C		2.8		MHz
$t_s$	Settling time	$V_{(STEP)PP} = 2$ V, $A_V = -1$ , $C_L = 10$ pF, $R_L = 10$ k $\Omega$		25°C		0.1%	1.5	$\mu$ s
						0.01%	3.9	
						0.1%	1.6	
						0.01%	4	
$\phi_m$	Phase margin	$R_L = 10$ k $\Omega$ ,	$C_L = 1000$ pF	25°C		61°		
	Gain margin	$R_L = 10$ k $\Omega$ ,	$C_L = 1000$ pF	25°C		15		dB

$^\dagger$  Full range is 0°C to 70°C for C suffix and -40°C to 125°C for I suffix. If not specified, full range is -40°C to 125°C.

$^\ddagger$  Depending on package dissipation rating



**TLV2470, TLV2471, TLV2472, TLV2473, TLV2474, TLV2475, TLV247xA**  
**FAMILY OF 600- $\mu$ A/Ch 2.8-MHz RAIL-TO-RAIL INPUT/OUTPUT**  
**HIGH-DRIVE OPERATIONAL AMPLIFIERS WITH SHUTDOWN**

SLOS232C - JUNE 1999 - REVISED AUGUST 2003

**electrical characteristics at specified free-air temperature,  $V_{DD} = 5$  V (unless otherwise noted)**

PARAMETER	TEST CONDITIONS	$T_A^\dagger$	MIN	TYP	MAX	UNIT	
$V_{IO}$ Input offset voltage		TLV247x	25°C	250	2200	$\mu$ V	
			Full range		2400		
		TLV247xA	25°C	250	1600		
			Full range		2000		
$\alpha_{VIO}$ Temperature coefficient of input offset voltage	$V_{IC} = V_{DD}/2$ , $V_O = V_{DD}/2$ , $R_S = 50 \Omega$			0.4		$\mu$ V/°C	
		25°C		1.7	50		
$I_{IO}$ Input offset current		TLV247xC	Full range		100	$\rho$ A	
		TLV247xl	Full range		300		
$I_{IB}$ Input bias current			25°C		2.5		50
		TLV247xC	Full range				100
		TLV247xl	Full range			300	
$V_{OH}$ High-level output voltage	$V_{IC} = V_{DD}/2$	$I_{OH} = -2.5$ mA	25°C	4.85	4.96	V	
			Full range		4.8		
		$I_{OH} = -10$ mA	25°C	4.72	4.82		
			Full range		4.65		
$V_{OL}$ Low-level output voltage	$V_{IC} = V_{DD}/2$	$I_{OL} = 2.5$ mA	25°C		0.07	0.15	V
			Full range			0.2	
		$I_{OL} = 10$ mA	25°C		0.178	0.28	
			Full range			0.35	
$I_{OS}$ Short-circuit output current	Sourcing		25°C		110	mA	
			Full range		60		
	Sourcing, Outside of rails‡	TLV247xC	Full range		61		
		TLV247xl	Full range		58		
	Sinking		25°C		90		
			Full range		60		
	Sinking, Outside of rails‡		25°C		63		
		TLV247xC	Full range		61		
		TLV247xl	Full range		58		
$I_O$ Output current	$V_O = 0.5$ V from rail		25°C		$\pm 35$	mA	
$A_{VD}$ Large-signal differential voltage amplification	$V_{O(PP)} = 3$ V, $R_L = 10$ k $\Omega$		25°C		92	120	dB
			Full range		91		
$r_{i(d)}$ Differential input resistance			25°C		$10^{12}$	$\Omega$	
$C_{IC}$ Common-mode input capacitance	$f = 10$ kHz		25°C		18.9	pF	
$z_o$ Closed-loop output impedance	$f = 10$ kHz, $A_V = 10$		25°C		1.8	$\Omega$	

† Full range is 0°C to 70°C for C suffix and -40°C to 125°C for l suffix. If not specified, full range is -40°C to 125°C.

‡ Depending on package dissipation rating



**TLV2470, TLV2471, TLV2472, TLV2473, TLV2474, TLV2475, TLV247xA**  
**FAMILY OF 600- $\mu$ A/Ch 2.8-MHz RAIL-TO-RAIL INPUT/OUTPUT**  
**HIGH-DRIVE OPERATIONAL AMPLIFIERS WITH SHUTDOWN**

SLOS232C - JUNE 1999 - REVISED AUGUST 2003

**electrical characteristics at specified free-air temperature,  $V_{DD} = 5$  V (unless otherwise noted) (continued)**

PARAMETER		TEST CONDITIONS		$T_A^\dagger$	MIN	TYP	MAX	UNIT
CMRR	Common-mode rejection ratio	$V_{IC} = 0$ to 5 V, $R_S = 50 \Omega$		25°C	64	84		dB
				Full range	63			
				Full range	58			
$k_{SVR}$	Supply voltage rejection ratio ( $\Delta V_{DD} / \Delta V_{IO}$ )	No load	$V_{IC} = V_{DD}/2$	25°C	74	90		dB
				Full range	66			
				25°C	77	92		
				Full range	66			
$I_{DD}$	Supply current (per channel)	$V_O = 2.5$ V,	No load	25°C		600	900	$\mu$ A
				Full range			1000	
$I_{DD(SHDN)}$	Supply current in shutdown mode (TLV2470, TLV2473, TLV2475) (per channel)	SHDN = 0 V		25°C		1000	2500	nA
				Full range			3000	
				Full range			6000	nA

$\dagger$  Full range is 0°C to 70°C for C suffix and -40°C to 125°C for I suffix. If not specified, full range is -40°C to 125°C.

**operating characteristics at specified free-air temperature,  $V_{DD} = 5$  V (unless otherwise noted)**

PARAMETER		TEST CONDITIONS		$T_A^\dagger$	MIN	TYP	MAX	UNIT
SR	Slew rate at unity gain	$V_{O(PP)} = 2$ V, $R_L = 10$ k $\Omega$	$C_L = 150$ pF,	25°C	1.1	1.5		V/ $\mu$ s
				Full range	0.7			
$V_n$	Equivalent input noise voltage			25°C		28		nV/ $\sqrt{Hz}$
				25°C		15		
$I_n$	Equivalent input noise current			25°C		0.39		pA/ $\sqrt{Hz}$
THD + N	Total harmonic distortion plus noise	$V_{O(PP)} = 4$ V, $R_L = 10$ k $\Omega$ , $f = 1$ kHz		25°C		$A_V = 1$	0.01%	
						$A_V = 10$	0.05%	
						$A_V = 100$	0.3%	
$t_{(on)}$	Amplifier turnon time	$R_L = OPEN^\ddagger$		25°C		5		$\mu$ s
$t_{(off)}$	Amplifier turnoff time			25°C		250		ns
	Gain-bandwidth product	$f = 10$ kHz,	$R_L = 600 \Omega$	25°C		2.8		MHz
$t_s$	Settling time	$V_{(STEP)PP} = 2$ V, $A_V = -1$ , $C_L = 10$ pF, $R_L = 10$ k $\Omega$		25°C	0.1%	1.8		$\mu$ s
					0.01%	3.3		
		$V_{(STEP)PP} = 2$ V, $A_V = -1$ , $C_L = 56$ pF, $R_L = 10$ k $\Omega$			0.1%	1.7		
					0.01%	3		
$\phi_m$	Phase margin	$R_L = 10$ k $\Omega$ ,	$C_L = 1000$ pF	25°C		68°		
	Gain margin	$R_L = 10$ k $\Omega$ ,	$C_L = 1000$ pF	25°C		23		dB

$\dagger$  Full range is 0°C to 70°C for C suffix and -40°C to 125°C for I suffix. If not specified, full range is -40°C to 125°C.

$\ddagger$  Disable and enable time are defined as the interval between application of logic signal to SHDN and the point at which the supply current has reached half its final value.





**TLV2470, TLV2471, TLV2472, TLV2473, TLV2474, TLV2475, TLV247xA**  
**FAMILY OF 600- $\mu$ A/Ch 2.8-MHz RAIL-TO-RAIL INPUT/OUTPUT**  
**HIGH-DRIVE OPERATIONAL AMPLIFIERS WITH SHUTDOWN**

SLOS232C - JUNE 1999 - REVISED AUGUST 2003

**TYPICAL CHARACTERISTICS**

**Table of Graphs**

			<b>FIGURE</b>
$V_{IO}$	Input offset voltage	vs Common-mode input voltage	1, 2
$I_{IB}$	Input bias current	vs Free-air temperature	3, 4
$I_{IO}$	Input offset current		
$V_{OH}$	High-level output voltage	vs High-level output current	5, 7
$V_{OL}$	Low-level output voltage	vs Low-level output current	6, 8
$Z_o$	Output impedance	vs Frequency	9
$I_{DD}$	Supply current	vs Supply voltage	10
PSRR	Power supply rejection ratio	vs Frequency	11
CMRR	Common-mode rejection ratio	vs Frequency	12
$V_n$	Equivalent input noise voltage	vs Frequency	13
$V_{O(PP)}$	Maximum peak-to-peak output voltage	vs Frequency	14, 15
$A_{VD}$	Differential voltage gain and phase	vs Frequency	16, 17
$\phi_m$	Phase margin	vs Load capacitance	18, 19
	Gain margin	vs Load capacitance	20, 21
SR	Slew rate	vs Supply voltage	22
		vs Free-air temperature	23
	Crosstalk	vs Frequency	24, 25
THD+N	Total harmonic distortion + noise	vs Frequency	26
$V_O$	Large and small signal follower	vs Frequency	27, 28
	Shutdown pulse response	vs Time	29 - 32
	Shutdown forward and reverse isolation	vs Time	33, 34
$I_{DD(SHDN)}$	Shutdown supply current	vs Frequency	35, 36
		vs Supply voltage	37
$I_{DD(SHDN)}$	Shutdown supply current	vs Free-air temperature	38
$I_{DD(SHDN)}$	Shutdown pulse current	vs Time	39, 40



# TLV2470, TLV2471, TLV2472, TLV2473, TLV2474, TLV2475, TLV247xA FAMILY OF 600- $\mu$ A/Ch 2.8-MHz RAIL-TO-RAIL INPUT/OUTPUT HIGH-DRIVE OPERATIONAL AMPLIFIERS WITH SHUTDOWN

SLOS232C - JUNE 1999 - REVISED AUGUST 2003

## TYPICAL CHARACTERISTICS

**INPUT OFFSET VOLTAGE  
vs  
COMMON-MODE INPUT VOLTAGE**

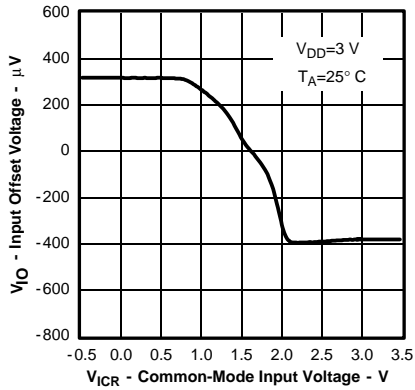

Figure 1

**INPUT OFFSET VOLTAGE  
vs  
COMMON-MODE INPUT VOLTAGE**

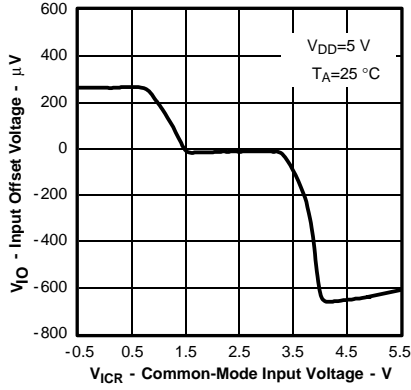

Figure 2

**INPUT BIAS AND INPUT OFFSET  
CURRENTS  
vs  
FREE-AIR TEMPERATURE**

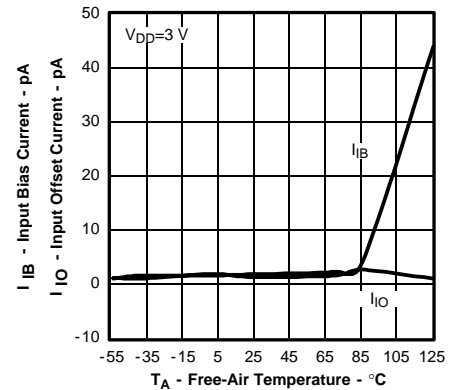

Figure 3

**INPUT BIAS AND INPUT OFFSET  
CURRENTS  
vs  
FREE-AIR TEMPERATURE**

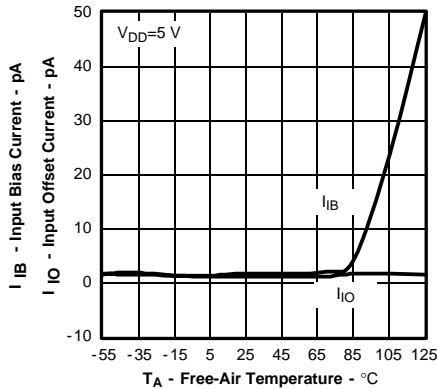

Figure 4

**HIGH-LEVEL OUTPUT VOLTAGE  
vs  
HIGH-LEVEL OUTPUT CURRENT**

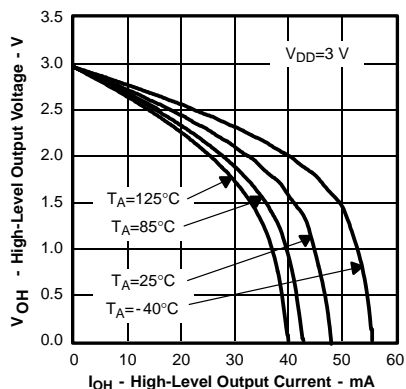

Figure 5

**LOW-LEVEL OUTPUT VOLTAGE  
vs  
LOW-LEVEL OUTPUT CURRENT**

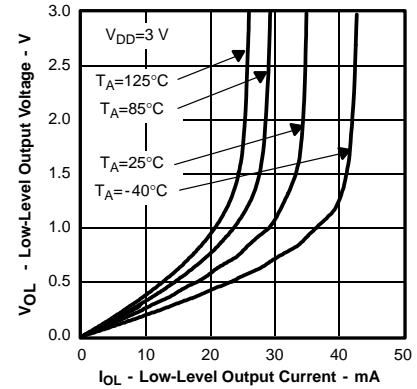

Figure 6

**HIGH-LEVEL OUTPUT VOLTAGE  
vs  
HIGH-LEVEL OUTPUT CURRENT**

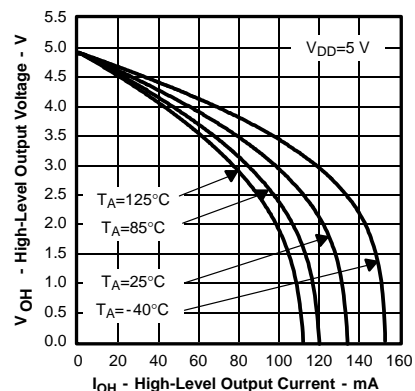

Figure 7

**LOW-LEVEL OUTPUT VOLTAGE  
vs  
LOW-LEVEL OUTPUT CURRENT**

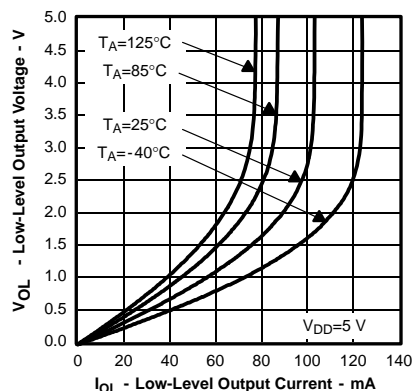

Figure 8

**OUTPUT IMPEDANCE  
vs  
FREQUENCY**

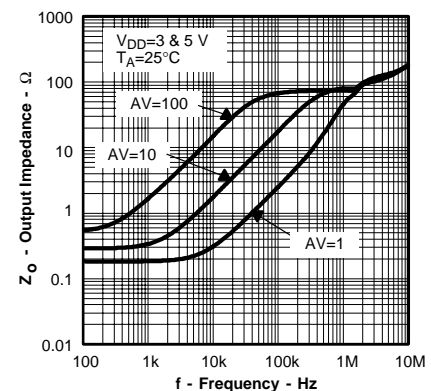

Figure 9



# TLV2470, TLV2471, TLV2472, TLV2473, TLV2474, TLV2475, TLV247xA FAMILY OF 600- $\mu$ A/Ch 2.8-MHz RAIL-TO-RAIL INPUT/OUTPUT HIGH-DRIVE OPERATIONAL AMPLIFIERS WITH SHUTDOWN

SLOS232C - JUNE 1999 - REVISED AUGUST 2003

## TYPICAL CHARACTERISTICS

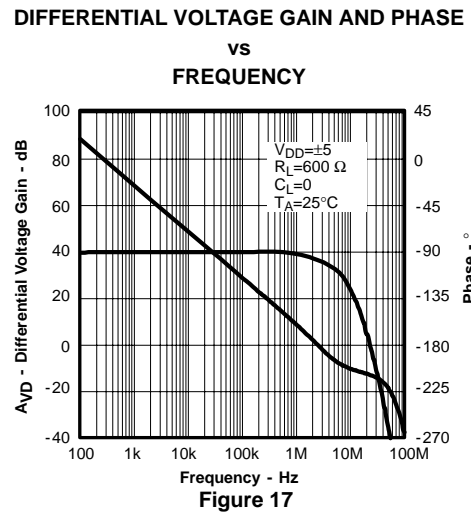
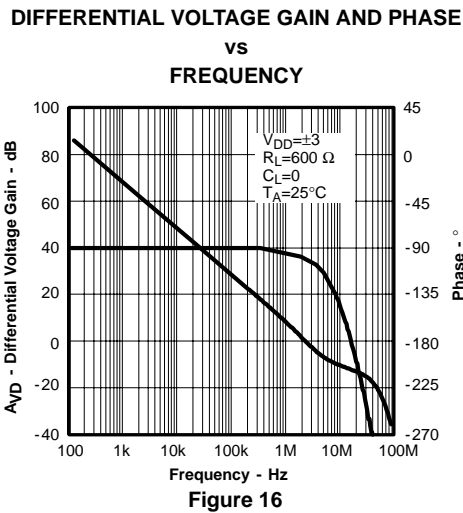
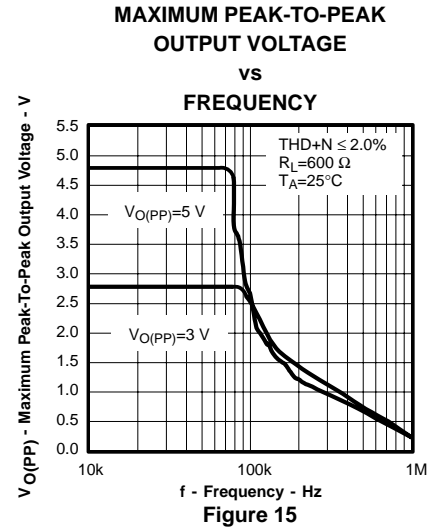
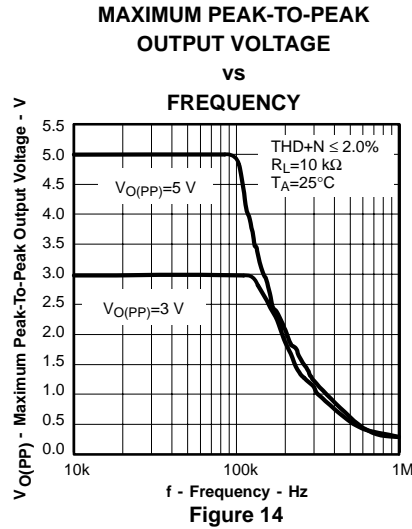
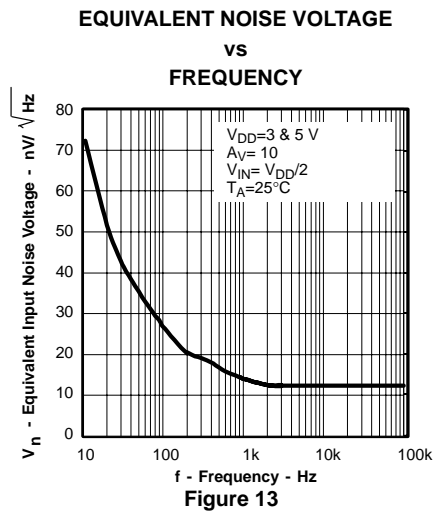
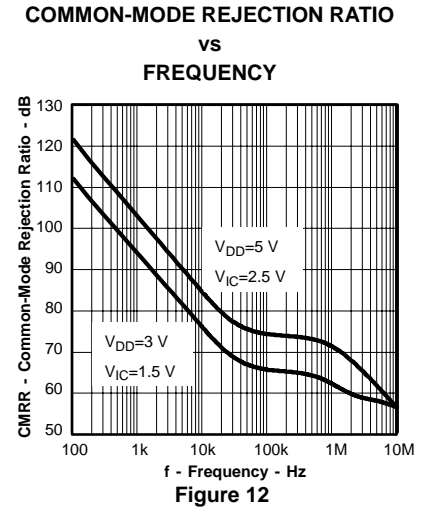
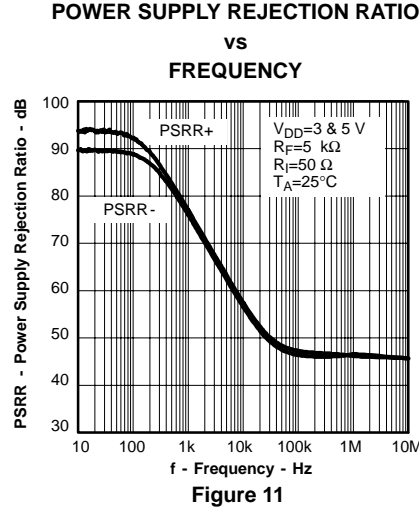
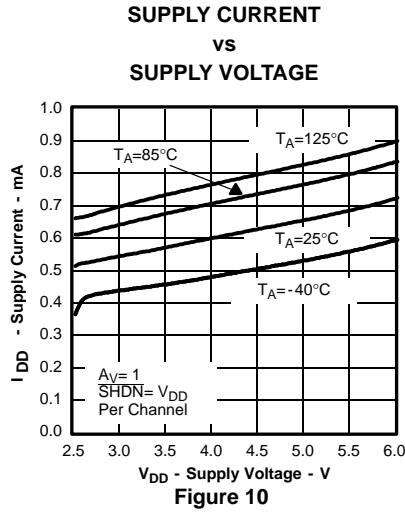

# TLV2470, TLV2471, TLV2472, TLV2473, TLV2474, TLV2475, TLV247xA

## FAMILY OF 600- $\mu$ A/Ch 2.8-MHz RAIL-TO-RAIL INPUT/OUTPUT

### HIGH-DRIVE OPERATIONAL AMPLIFIERS WITH SHUTDOWN

SLOS232C - JUNE 1999 - REVISED AUGUST 2003

#### TYPICAL CHARACTERISTICS

**PHASE MARGIN**  
vs  
**LOAD CAPACITANCE**

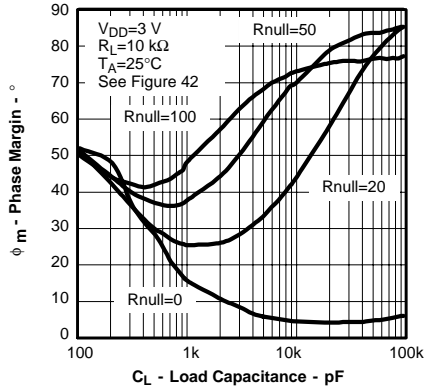

Figure 18

**PHASE MARGIN**  
vs  
**LOAD CAPACITANCE**

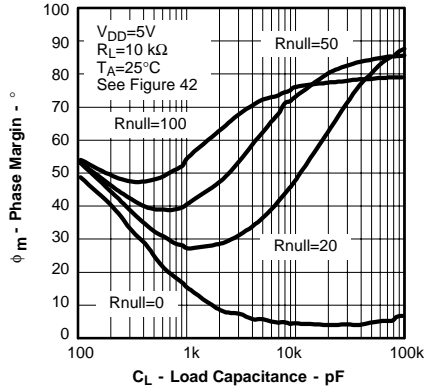

Figure 19

**GAIN MARGIN**  
vs  
**LOAD CAPACITANCE**

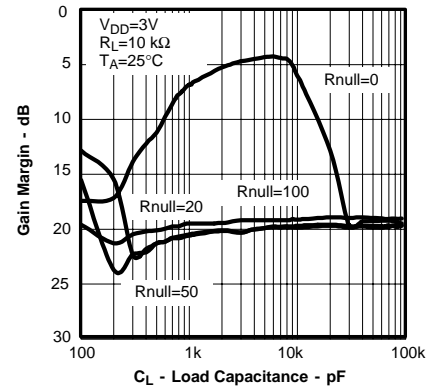

Figure 20

**GAIN MARGIN**  
vs  
**LOAD CAPACITANCE**

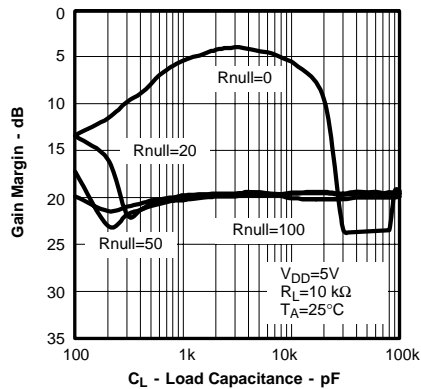

Figure 21

**GAIN-BANDWIDTH PRODUCT**  
vs  
**SUPPLY VOLTAGE**

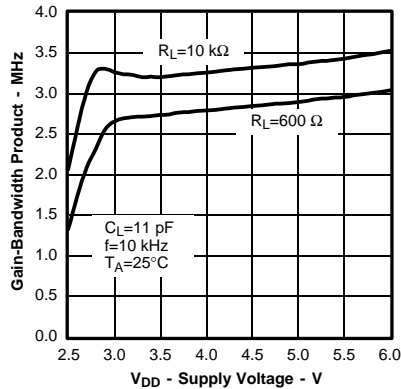

Figure 22

**SLEW RATE**  
vs  
**SUPPLY VOLTAGE**

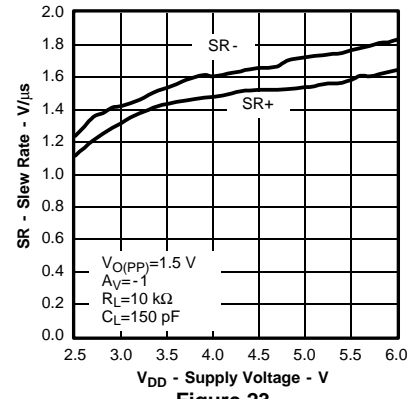

Figure 23

**SLEW RATE**  
vs  
**FREE-AIR TEMPERATURE**

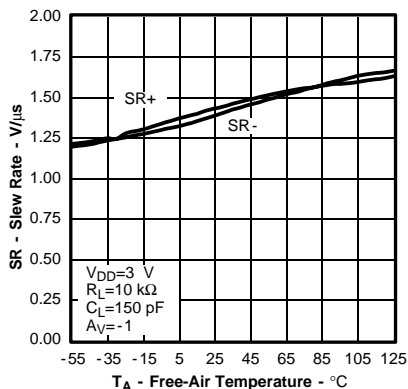

Figure 24

**SLEW RATE**  
vs  
**FREE-AIR TEMPERATURE**

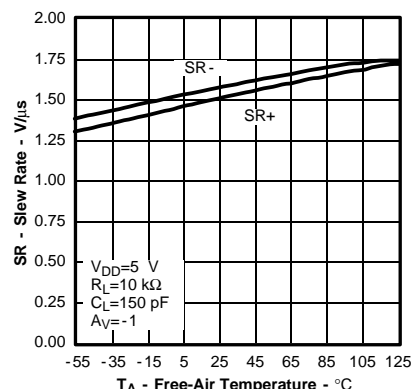

Figure 25



# TLV2470, TLV2471, TLV2472, TLV2473, TLV2474, TLV2475, TLV247xA FAMILY OF 600- $\mu$ A/Ch 2.8-MHz RAIL-TO-RAIL INPUT/OUTPUT HIGH-DRIVE OPERATIONAL AMPLIFIERS WITH SHUTDOWN

SLOS232C - JUNE 1999 - REVISED AUGUST 2003

## TYPICAL CHARACTERISTICS

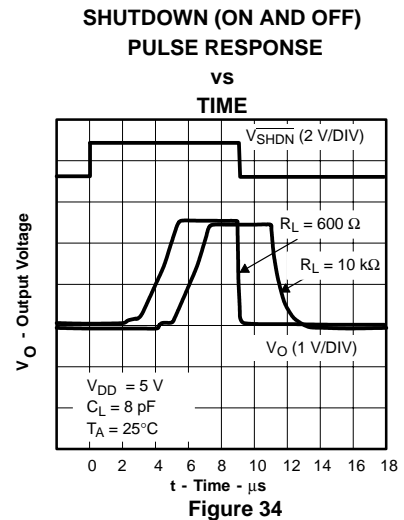
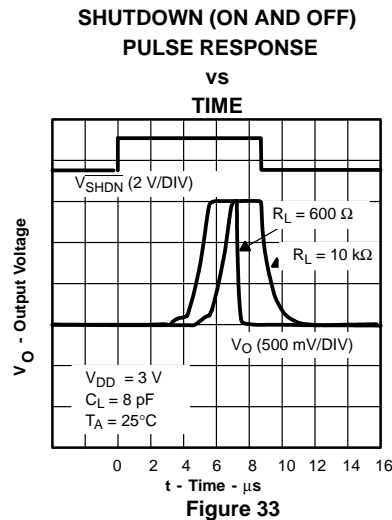
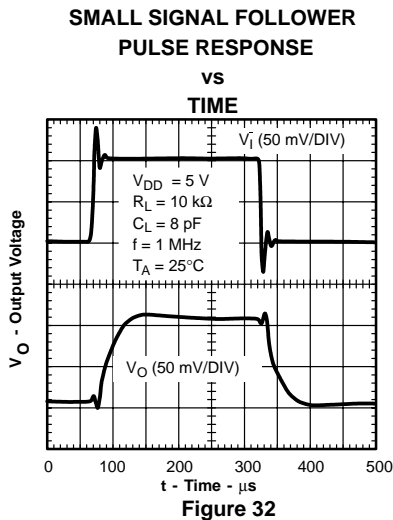
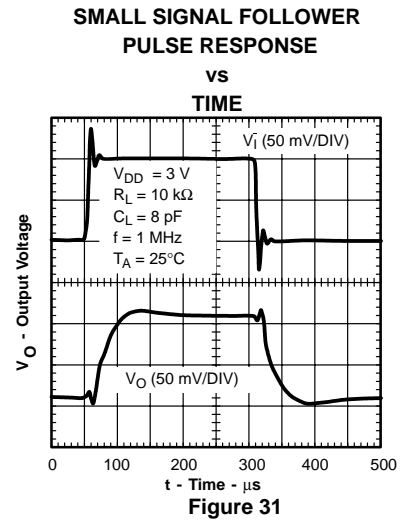
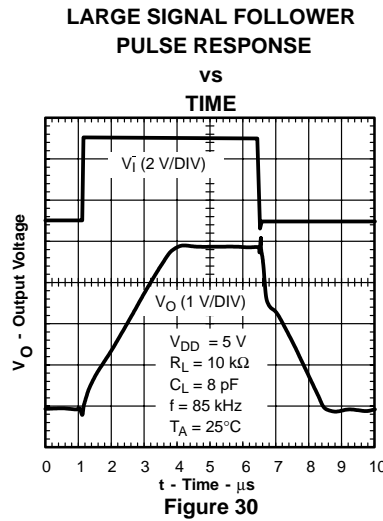
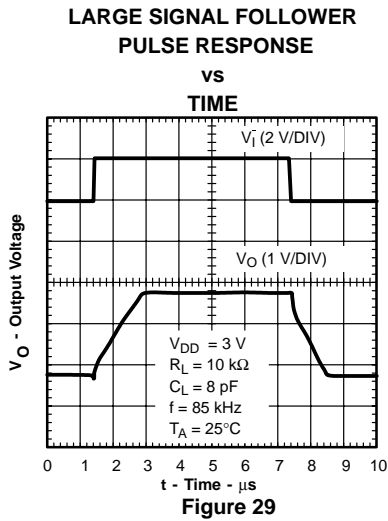
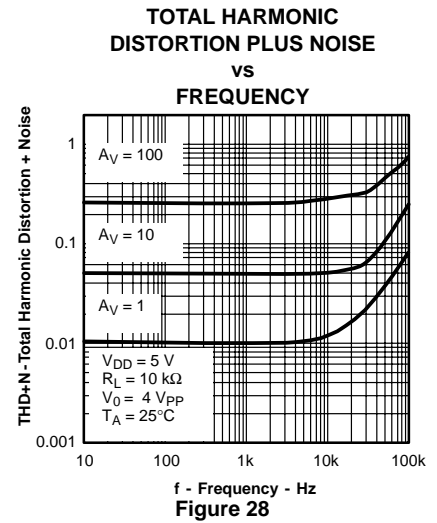
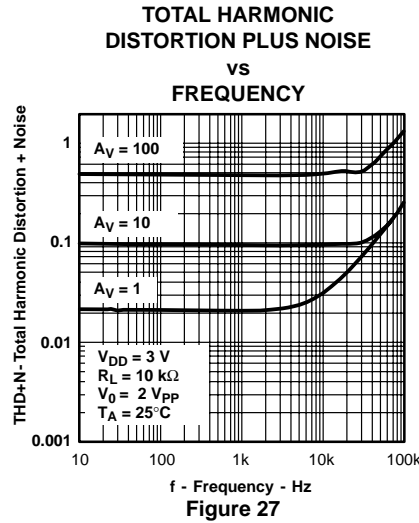
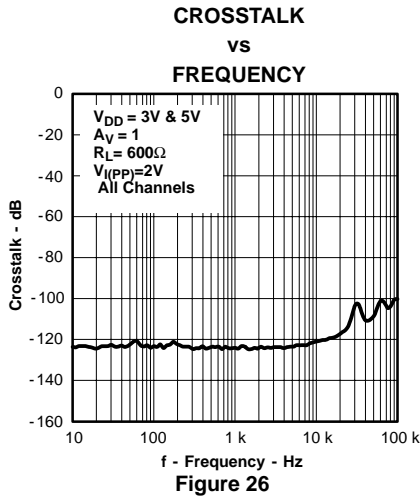

# TLV2470, TLV2471, TLV2472, TLV2473, TLV2474, TLV2475, TLV247xA FAMILY OF 600- $\mu$ A/Ch 2.8-MHz RAIL-TO-RAIL INPUT/OUTPUT HIGH-DRIVE OPERATIONAL AMPLIFIERS WITH SHUTDOWN

SLOS232C - JUNE 1999 - REVISED AUGUST 2003

## TYPICAL CHARACTERISTICS

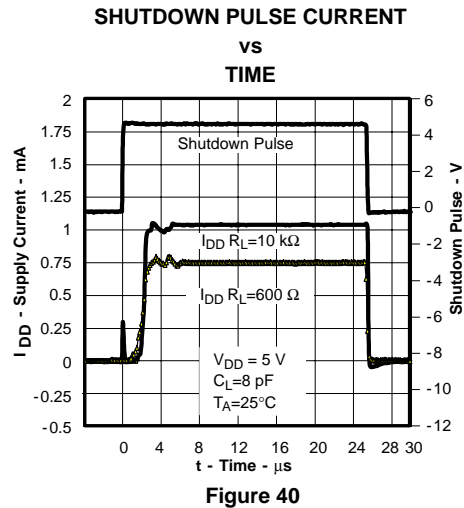
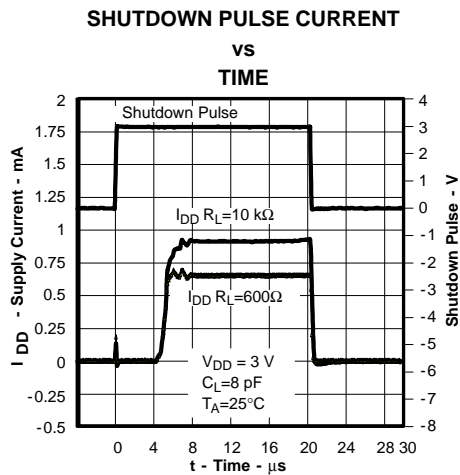
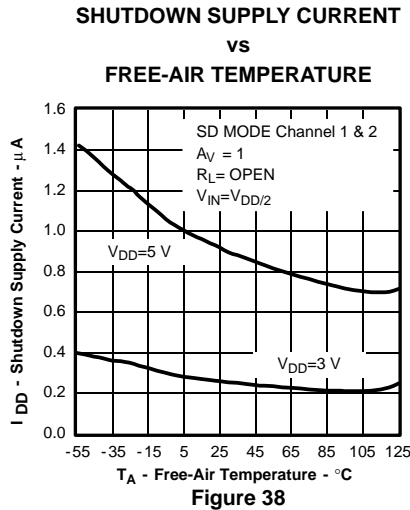
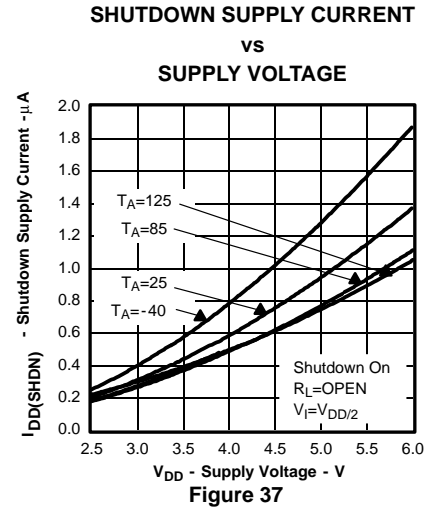
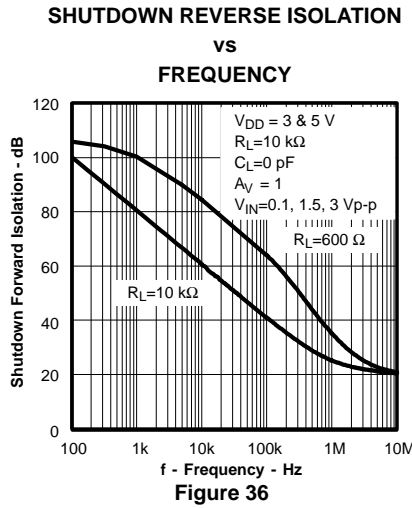
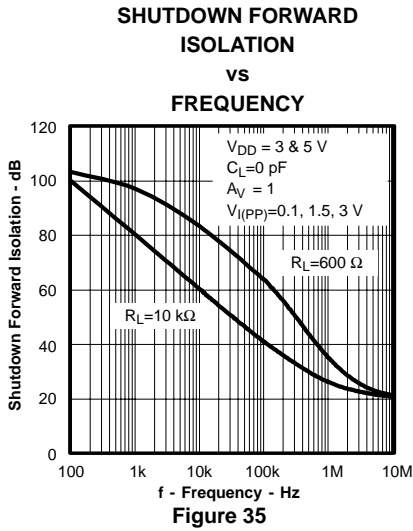

PARAMETER MEASUREMENT INFORMATION

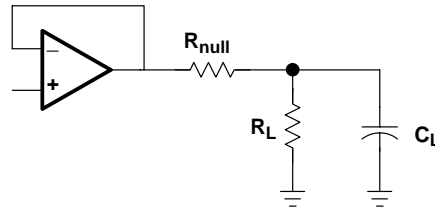

Figure 41

APPLICATION INFORMATION

driving a capacitive load

When the amplifier is configured in this manner, capacitive loading directly on the output will decrease the device's phase margin leading to high frequency ringing or oscillations. Therefore, for capacitive loads of greater than 10 pF, it is recommended that a resistor be placed in series ( $R_{NULL}$ ) with the output of the amplifier, as shown in Figure 42. A minimum value of 20  $\Omega$  should work well for most applications.

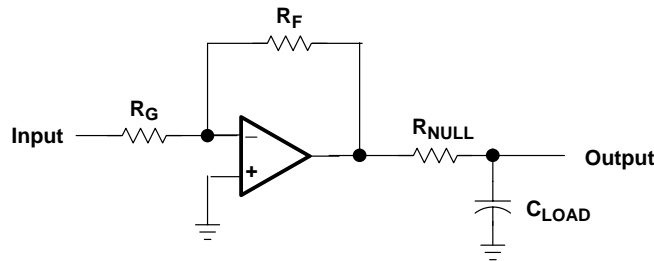

Figure 42. Driving a Capacitive Load

offset voltage

The output offset voltage, ( $V_{OO}$ ) is the sum of the input offset voltage ( $V_{IO}$ ) and both input bias currents ( $I_{IB}$ ) times the corresponding gains. The following schematic and formula can be used to calculate the output offset voltage:

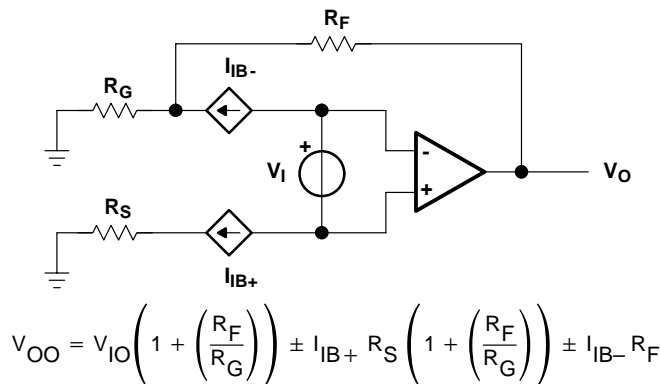
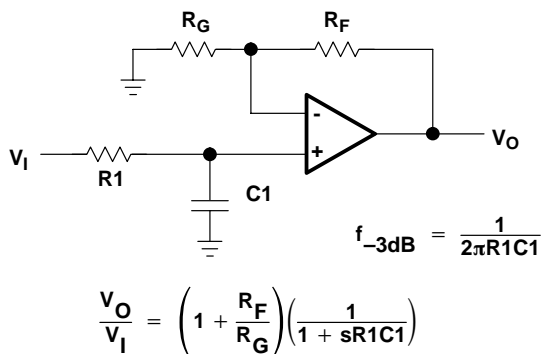

Figure 43. Output Offset Voltage Model

**APPLICATION INFORMATION**

**general configurations**

When receiving low-level signals, limiting the bandwidth of the incoming signals into the system is often required. The simplest way to accomplish this is to place an RC filter at the noninverting terminal of the amplifier (see Figure 44).



**Figure 44. Single-Pole Low-Pass Filter**

If even more attenuation is needed, a multiple pole filter is required. The Sallen-Key filter can be used for this task. For best results, the amplifier should have a bandwidth that is 8 to 10 times the filter frequency bandwidth. Failure to do this can result in phase shift of the amplifier.

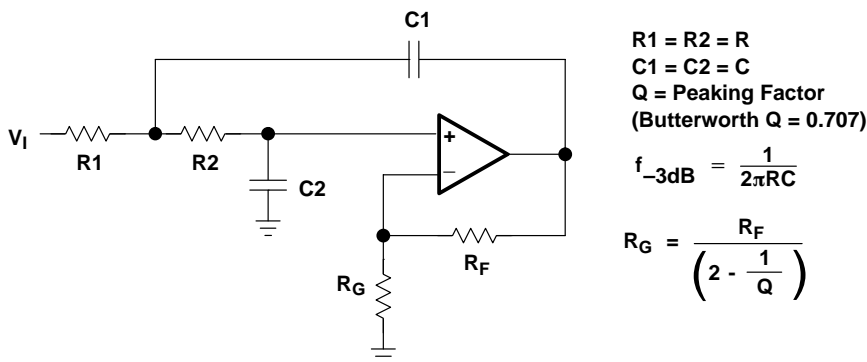

**Figure 45. 2-Pole Low-Pass Sallen-Key Filter**

**shutdown function**

Three members of the TLV247x family (TLV2470/3/5) have a shutdown terminal for conserving battery life in portable applications. When the shutdown terminal is tied low, the supply current is reduced to 350 nA/channel, the amplifier is disabled, and the outputs are placed in a high impedance mode. To enable the amplifier, the shutdown terminal can either be left floating or pulled high. When the shutdown terminal is left floating, care should be taken to ensure that parasitic leakage current at the shutdown terminal does not inadvertently place the operational amplifier into shutdown. The shutdown terminal threshold is always referenced to  $V_{DD}/2$ . Therefore, when operating the device with split supply voltages (e.g.  $\pm 2.5$  V), the shutdown terminal needs to be pulled to  $V_{DD-}$  (not GND) to disable the operational amplifier.



## APPLICATION INFORMATION

### shutdown function (continued)

The amplifier's output with a shutdown pulse is shown in Figures 33 and 34. The amplifier is powered with a single 5-V supply and configured as a noninverting configuration with a gain of 5. The amplifier turnon and turnoff times are measured from the 50% point of the shutdown pulse to the 50% point of the output waveform. The times for the single, dual, and quad are listed in the data tables.

Figures 35 and 36 show the amplifier's forward and reverse isolation in shutdown. The operational amplifier is powered by  $\pm 1.35$ -V supplies and configured as a voltage follower ( $A_V = 1$ ). The isolation performance is plotted across frequency using 0.1- $V_{PP}$ , 1.5- $V_{PP}$ , and 2.5- $V_{PP}$  input signals. During normal operation, the amplifier would not be able to handle a 2.5- $V_{PP}$  input signal with a supply voltage of  $\pm 1.35$  V since it exceeds the common-mode input voltage range ( $V_{ICR}$ ). However, this curve illustrates that the amplifier remains in shutdown even under a worst case scenario.

### circuit layout considerations

To achieve the levels of high performance of the TLV247x, follow proper printed-circuit board design techniques. A general set of guidelines is given in the following.

- Ground planes - It is highly recommended that a ground plane be used on the board to provide all components with a low inductive ground connection. However, in the areas of the amplifier inputs and output, the ground plane can be removed to minimize the stray capacitance.
- Proper power supply decoupling - Use a 6.8- $\mu$ F tantalum capacitor in parallel with a 0.1- $\mu$ F ceramic capacitor on each supply terminal. It may be possible to share the tantalum among several amplifiers depending on the application, but a 0.1- $\mu$ F ceramic capacitor should always be used on the supply terminal of every amplifier. In addition, the 0.1- $\mu$ F capacitor should be placed as close as possible to the supply terminal. As this distance increases, the inductance in the connecting trace makes the capacitor less effective. The designer should strive for distances of less than 0.1 inches between the device power terminals and the ceramic capacitors.
- Sockets - Sockets can be used but are not recommended. The additional lead inductance in the socket pins will often lead to stability problems. Surface-mount packages soldered directly to the printed-circuit board is the best implementation.
- Short trace runs/compact part placements - Optimum high performance is achieved when stray series inductance has been minimized. To realize this, the circuit layout should be made as compact as possible, thereby minimizing the length of all trace runs. Particular attention should be paid to the inverting input of the amplifier. Its length should be kept as short as possible. This will help to minimize stray capacitance at the input of the amplifier.
- Surface-mount passive components - Using surface-mount passive components is recommended for high performance amplifier circuits for several reasons. First, because of the extremely low lead inductance of surface-mount components, the problem with stray series inductance is greatly reduced. Second, the small size of surface-mount components naturally leads to a more compact layout thereby minimizing both stray inductance and capacitance. If leaded components are used, it is recommended that the lead lengths be kept as short as possible.

# TLV2470, TLV2471, TLV2472, TLV2473, TLV2474, TLV2475, TLV247xA FAMILY OF 600- $\mu$ A/Ch 2.8-MHz RAIL-TO-RAIL INPUT/OUTPUT HIGH-DRIVE OPERATIONAL AMPLIFIERS WITH SHUTDOWN

SLOS232C - JUNE 1999 - REVISED AUGUST 2003

## APPLICATION INFORMATION

### general PowerPAD™ design considerations

The TLV247x is available in a thermally-enhanced PowerPAD family of packages. These packages are constructed using a downset leadframe upon which the die is mounted [see Figure 46(a) and Figure 46(b)]. This arrangement results in the lead frame being exposed as a thermal pad on the underside of the package [see Figure 46(c)]. Because this thermal pad has direct thermal contact with the die, excellent thermal performance can be achieved by providing a good thermal path away from the thermal pad.

The PowerPAD package allows for both assembly and thermal management in one manufacturing operation. During the surface-mount solder operation (when the leads are being soldered), the thermal pad can also be soldered to a copper area underneath the package. Through the use of thermal paths within this copper area, heat can be conducted away from the package into either a ground plane or other heat dissipating device.

The PowerPAD package represents a breakthrough in combining the small area and ease of assembly of surface mount with the, heretofore, awkward mechanical methods of heatsinking.

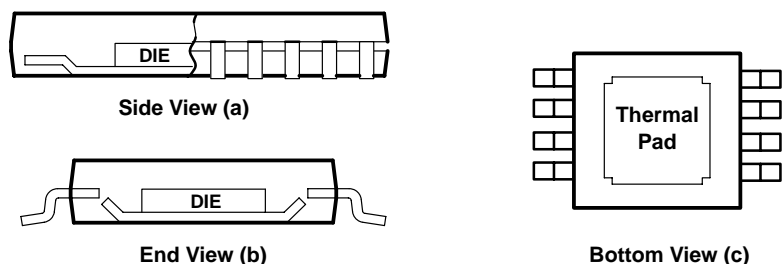

NOTE A: The thermal pad is electrically isolated from all terminals in the package.

**Figure 46. Views of Thermally Enhanced DGN Package**

Although there are many ways to properly heatsink the PowerPAD package, the following steps illustrate the recommended approach.

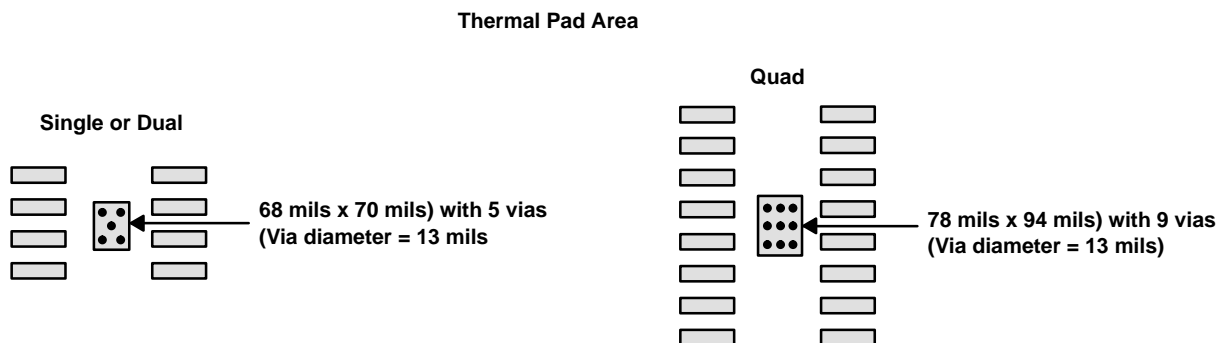

**Figure 47. PowerPAD PCB Etch and Via Pattern**

PowerPAD is a trademark of Texas Instruments Incorporated.



POST OFFICE BOX 655303 • DALLAS, TEXAS 75265

## APPLICATION INFORMATION

### general PowerPAD design considerations (continued)

1. Prepare the PCB with a top side etch pattern as shown in Figure 47. There should be etch for the leads as well as etch for the thermal pad.
2. Place five holes (dual) or nine holes (quad) in the area of the thermal pad. These holes should be 13 mils in diameter. Keep them small so that solder wicking through the holes is not a problem during reflow.
3. Additional vias may be placed anywhere along the thermal plane outside of the thermal pad area. This helps dissipate the heat generated by the TLV247x IC. These additional vias may be larger than the 13-mil diameter vias directly under the thermal pad. They can be larger because they are not in the thermal pad area to be soldered so that wicking is not a problem.
4. Connect all holes to the internal ground plane.
5. When connecting these holes to the ground plane, **do not** use the typical web or spoke via connection methodology. Web connections have a high thermal resistance connection that is useful for slowing the heat transfer during soldering operations. This makes the soldering of vias that have plane connections easier. In this application, however, low thermal resistance is desired for the most efficient heat transfer. Therefore, the holes under the TLV247x PowerPAD package should make their connection to the internal ground plane with a complete connection around the entire circumference of the plated-through hole.
6. The top-side solder mask should leave the terminals of the package and the thermal pad area with its five holes (dual) or nine holes (quad) exposed. The bottom-side solder mask should cover the five or nine holes of the thermal pad area. This prevents solder from being pulled away from the thermal pad area during the reflow process.
7. Apply solder paste to the exposed thermal pad area and all of the IC terminals.
8. With these preparatory steps in place, the TLV247x IC is simply placed in position and run through the solder reflow operation as any standard surface-mount component. This results in a part that is properly installed.

For a given  $\theta_{JA}$ , the maximum power dissipation is shown in Figure 48 and is calculated by the following formula:

$$P_D = \left( \frac{T_{MAX} - T_A}{\theta_{JA}} \right)$$

Where:

$P_D$  = Maximum power dissipation of TLV247x IC (watts)

$T_{MAX}$  = Absolute maximum junction temperature (150°C)

$T_A$  = Free-ambient air temperature (°C)

$\theta_{JA}$  =  $\theta_{JC} + \theta_{CA}$

$\theta_{JC}$  = Thermal coefficient from junction to case

$\theta_{CA}$  = Thermal coefficient from case to ambient air (°C/W)

**TLV2470, TLV2471, TLV2472, TLV2473, TLV2474, TLV2475, TLV247xA**  
**FAMILY OF 600- $\mu$ A/Ch 2.8-MHz RAIL-TO-RAIL INPUT/OUTPUT**  
**HIGH-DRIVE OPERATIONAL AMPLIFIERS WITH SHUTDOWN**

SLOS232C - JUNE 1999 - REVISED AUGUST 2003

**APPLICATION INFORMATION**

**general PowerPAD design considerations (continued)**

**MAXIMUM POWER DISSIPATION  
 VS  
 FREE-AIR TEMPERATURE**

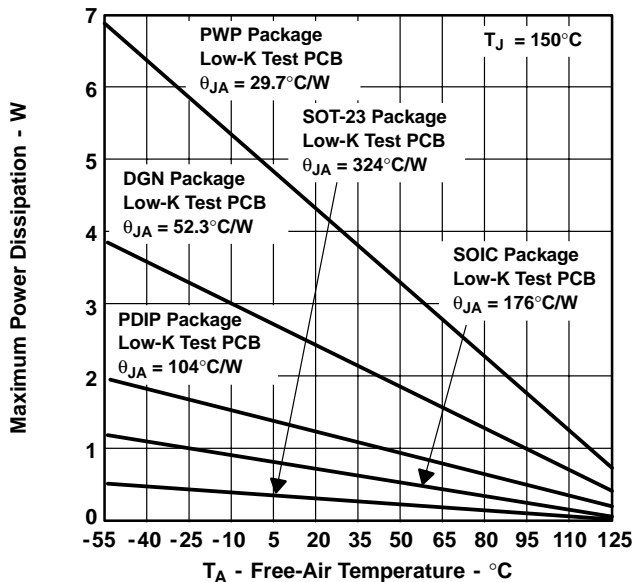

NOTE A: Results are with no air flow and using JEDEC Standard Low-K test PCB.

**Figure 48. Maximum Power Dissipation vs Free-Air Temperature**

The next consideration is the package constraints. The two sources of heat within an amplifier are quiescent power and output power. The designer should never forget about the quiescent heat generated within the device, especially multi-amplifier devices. Because these devices have linear output stages (Class A-B), most of the heat dissipation is at low output voltages with high output currents. Figure 49 to Figure 54 show this effect, along with the quiescent heat, with an ambient air temperature of 70°C and 125°C. When using  $V_{DD} = 3$  V, there is generally not a heat problem with an ambient air temperature of 70°C. But, when using  $V_{DD} = 5$  V, the packages are severely limited in the amount of heat it can dissipate. The other key factor when looking at these graphs is how the devices are mounted on the PCB. The PowerPAD devices are extremely useful for heat dissipation. But, the device should always be soldered to a copper plane to fully use the heat dissipation properties of the PowerPAD. The SOIC package, on the other hand, is highly dependent on how it is mounted on the PCB. As more trace and copper area is placed around the device,  $\theta_{JA}$  decreases and the heat dissipation capability increases. The currents and voltages shown in these graphs are for the total package. For the dual or quad amplifier packages, the sum of the RMS output currents and voltages should be used to choose the proper package.



# TLV2470, TLV2471, TLV2472, TLV2473, TLV2474, TLV2475, TLV247xA FAMILY OF 600- $\mu$ A/Ch 2.8-MHz RAIL-TO-RAIL INPUT/OUTPUT HIGH-DRIVE OPERATIONAL AMPLIFIERS WITH SHUTDOWN

SLOS232C - JUNE 1999 - REVISED AUGUST 2003

## APPLICATION INFORMATION

### general PowerPAD design considerations (continued)

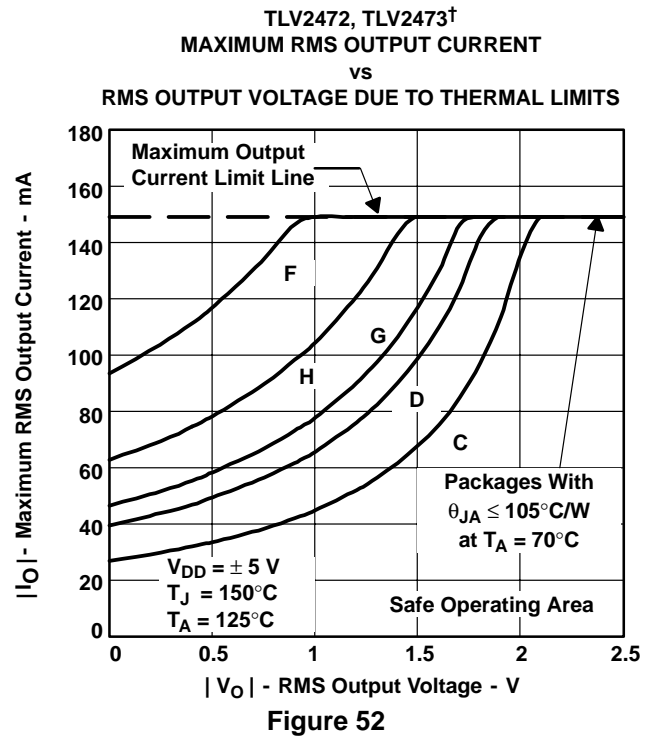
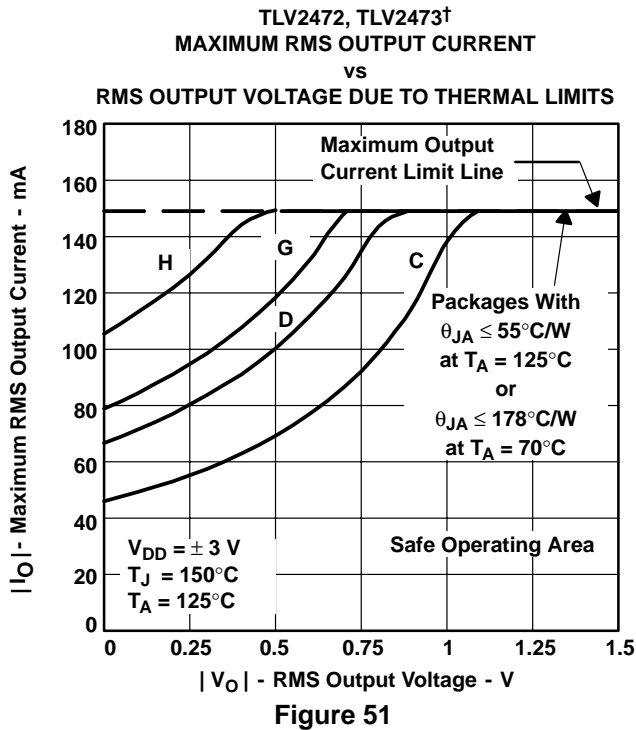
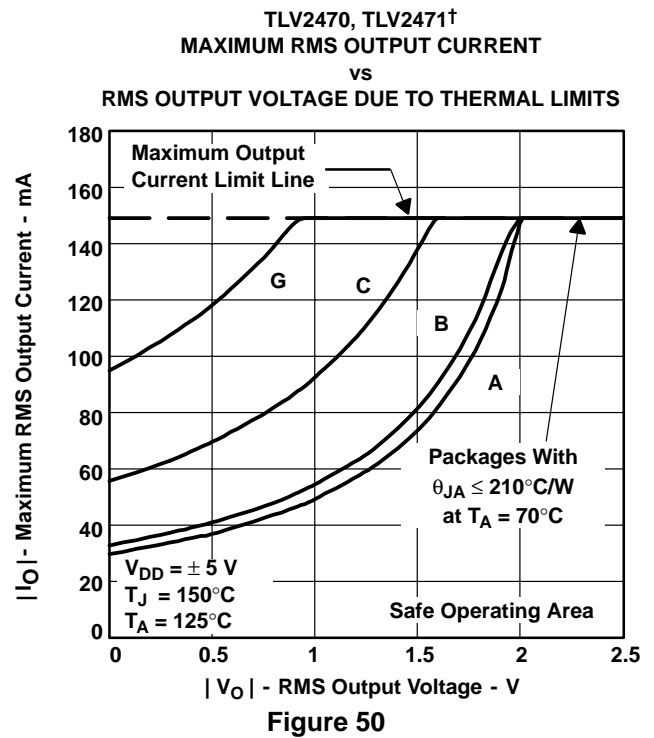
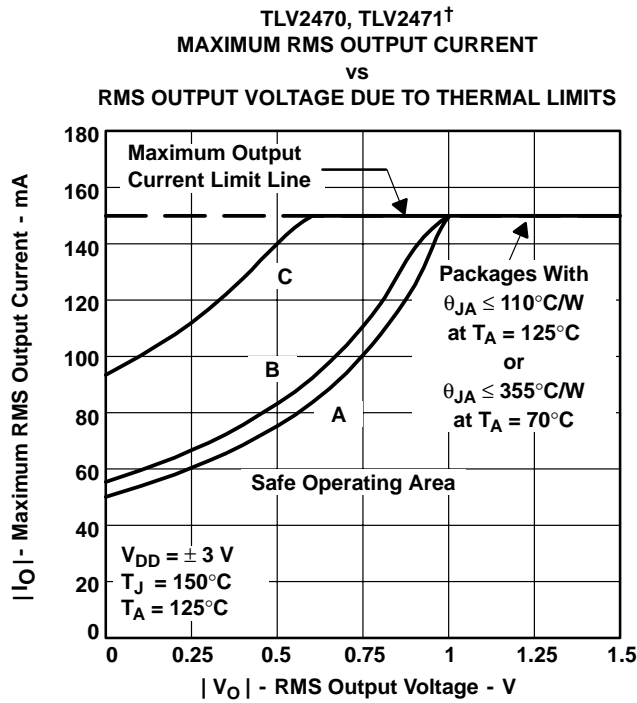

<sup>†</sup> A - SOT23(5); B - SOT23 (6); C - SOIC (8); D - SOIC (14); E - SOIC (16); F - MSOP PP (8); G - PDIP (8); H - PDIP (14); I - PDIP (16); J - TSSOP PP (14/16)

**TLV2470, TLV2471, TLV2472, TLV2473, TLV2474, TLV2475, TLV247xA**  
**FAMILY OF 600- $\mu$ A/Ch 2.8-MHz RAIL-TO-RAIL INPUT/OUTPUT**  
**HIGH-DRIVE OPERATIONAL AMPLIFIERS WITH SHUTDOWN**

SLOS232C - JUNE 1999 - REVISED AUGUST 2003

**APPLICATION INFORMATION**

**general PowerPAD design considerations (continued)**

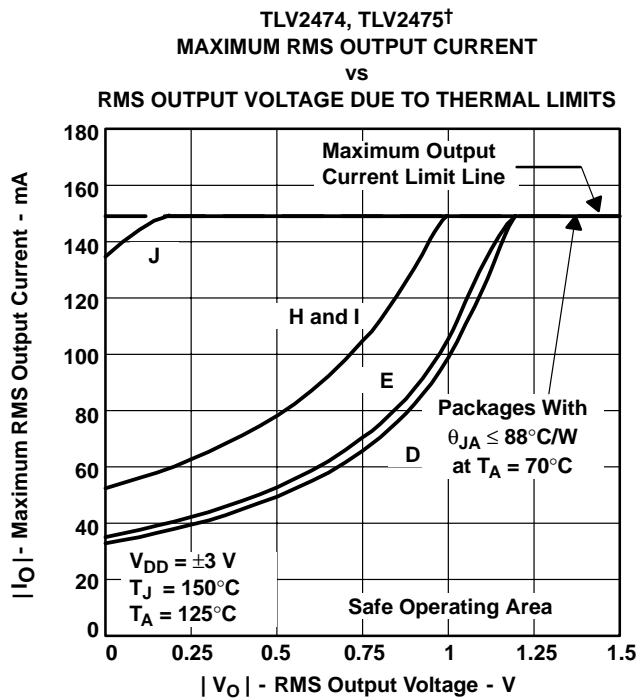

**Figure 53**

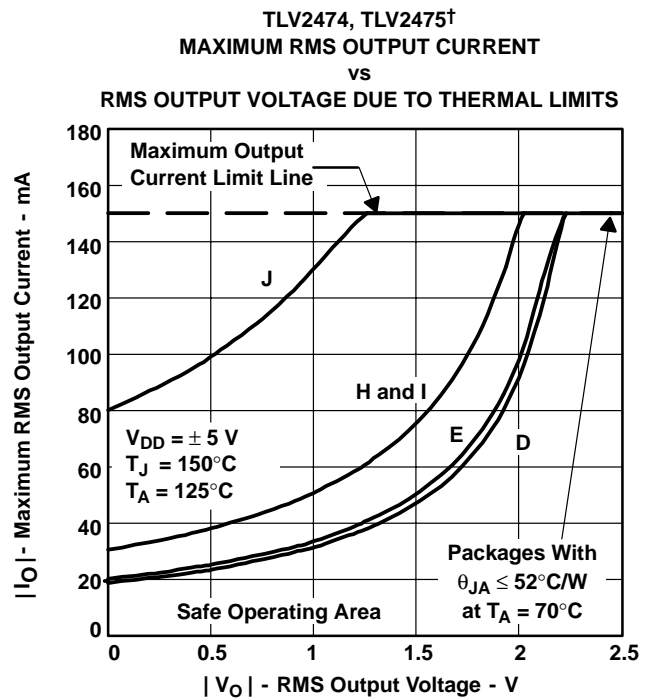

**Figure 54**

† A - SOT23(5); B - SOT23 (6); C - SOIC (8); D - SOIC (14); E - SOIC (16); F - MSOP PP (8); G - PDIP (8); H - PDIP (14); I - PDIP (16); J - TSSOP PP (14/16)

# TLV2470, TLV2471, TLV2472, TLV2473, TLV2474, TLV2475, TLV247xA FAMILY OF 600- $\mu$ A/Ch 2.8-MHz RAIL-TO-RAIL INPUT/OUTPUT HIGH-DRIVE OPERATIONAL AMPLIFIERS WITH SHUTDOWN

SLOS232C - JUNE 1999 - REVISED AUGUST 2003

## APPLICATION INFORMATION

### macromodel information

Macromodel information provided was derived using Microsim *Parts*<sup>™</sup>, the model generation software used with Microsim *PSpice*<sup>™</sup>. The Boyle macromodel (see Note 2) and subcircuit in Figure 55 are generated using the TLV247x typical electrical and operating characteristics at  $T_A = 25^\circ\text{C}$ . Using this information, output simulations of the following key parameters can be generated to a tolerance of 20% (in most cases):

- Maximum positive output voltage swing
- Maximum negative output voltage swing
- Slew rate
- Quiescent power dissipation
- Input bias current
- Open-loop voltage amplification
- Unity-gain frequency
- Common-mode rejection ratio
- Phase margin
- DC output resistance
- AC output resistance
- Short-circuit output current limit

NOTE 1: G. R. Boyle, B. M. Cohn, D. O. Pederson, and J. E. Solomon, "Macromodeling of Integrated Circuit Operational Amplifiers," *IEEE Journal of Solid-State Circuits*, SC-9, 353 (1974).

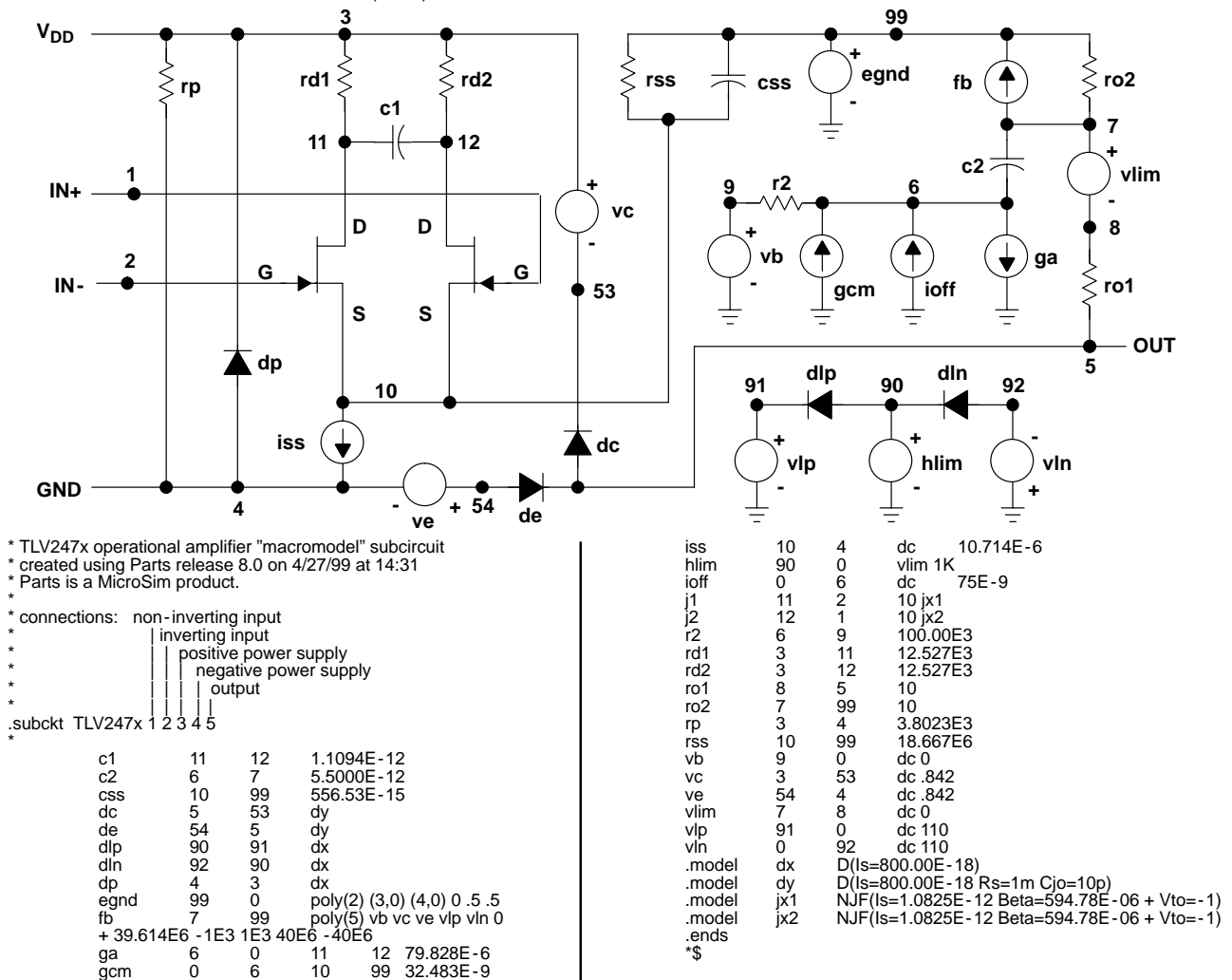

**Figure 55. Boyle Macromodel and Subcircuit**

*PSpice* and *Parts* are trademarks of MicroSim Corporation.



PWP (R-PDSO-G\*\*) 20 PIN SHOWN

PowerPAD™ PLASTIC SMALL-OUTLINE PACKAGE

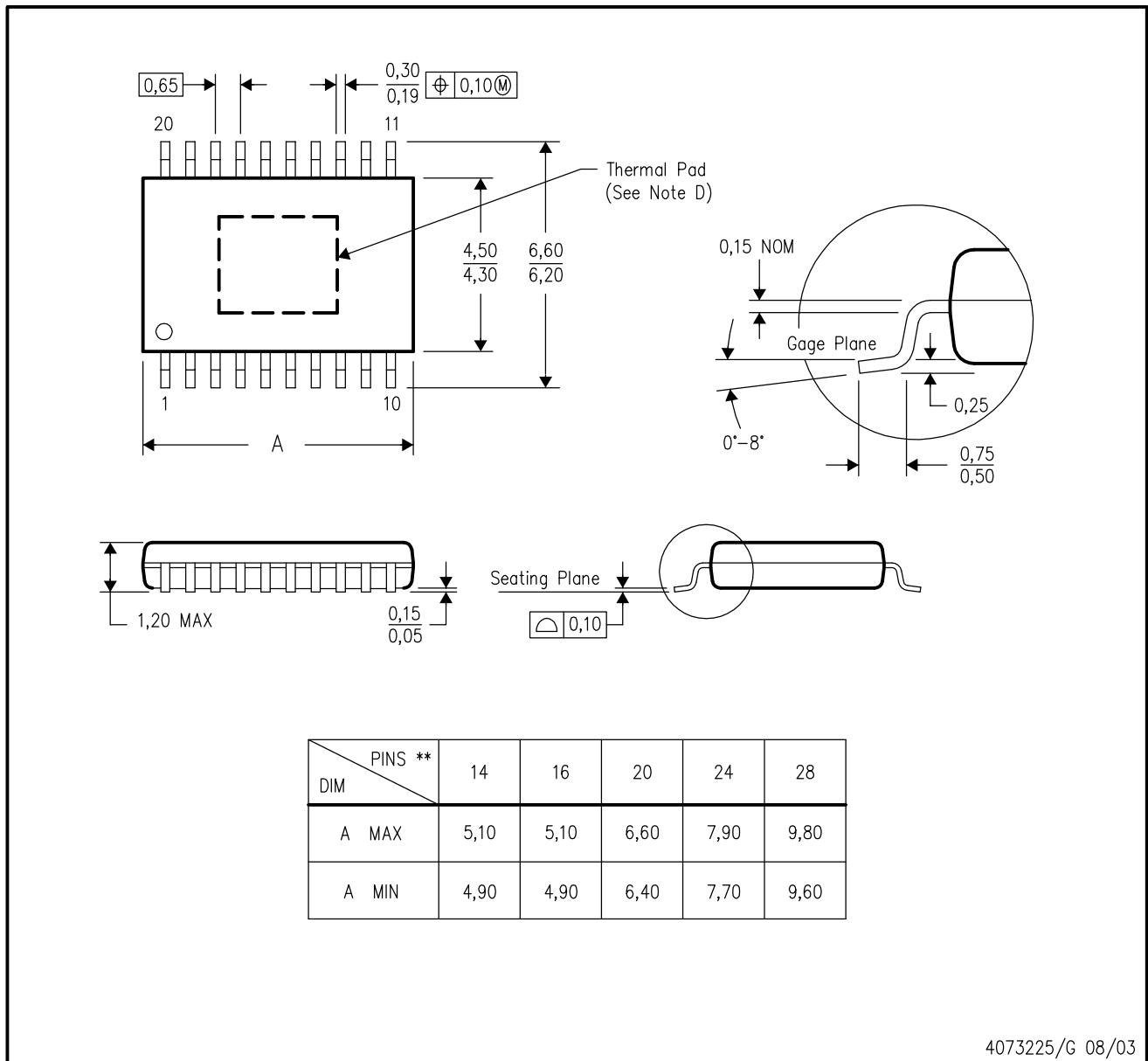

4073225/G 08/03

- NOTES:
- A. All linear dimensions are in millimeters.
  - B. This drawing is subject to change without notice.
  - C. Body dimensions do not include mold flash or protrusions.
  - D. This package is designed to be soldered to a thermal pad on the board. Refer to Technical Brief, PowerPad Thermally Enhanced Package, Texas Instruments Literature No. SLMA002 for information regarding recommended board layout. This document is available at [www.ti.com](http://www.ti.com) <<http://www.ti.com>>.
  - E. Falls within JEDEC MO-153

PowerPAD is a trademark of Texas Instruments.



P (R-PDIP-T8)

PLASTIC DUAL-IN-LINE



4040082/D 05/98

- NOTES: A. All linear dimensions are in inches (millimeters).  
 B. This drawing is subject to change without notice.  
 C. Falls within JEDEC MS-001

For the latest package information, go to [http://www.ti.com/sc/docs/package/pkg\\_info.htm](http://www.ti.com/sc/docs/package/pkg_info.htm)



N (R-PDIP-T\*\*)

PLASTIC DUAL-IN-LINE PACKAGE

16 PINS SHOWN



- NOTES:
- A. All linear dimensions are in inches (millimeters).
  - B. This drawing is subject to change without notice.
  - $\triangle C$  Falls within JEDEC MS-001, except 18 and 20 pin minimum body length (Dim A).
  - $\triangle D$  The 20 pin end lead shoulder width is a vendor option, either half or full width.

4040049/E 12/2002

DBV (R-PDSO-G5)

PLASTIC SMALL-OUTLINE PACKAGE

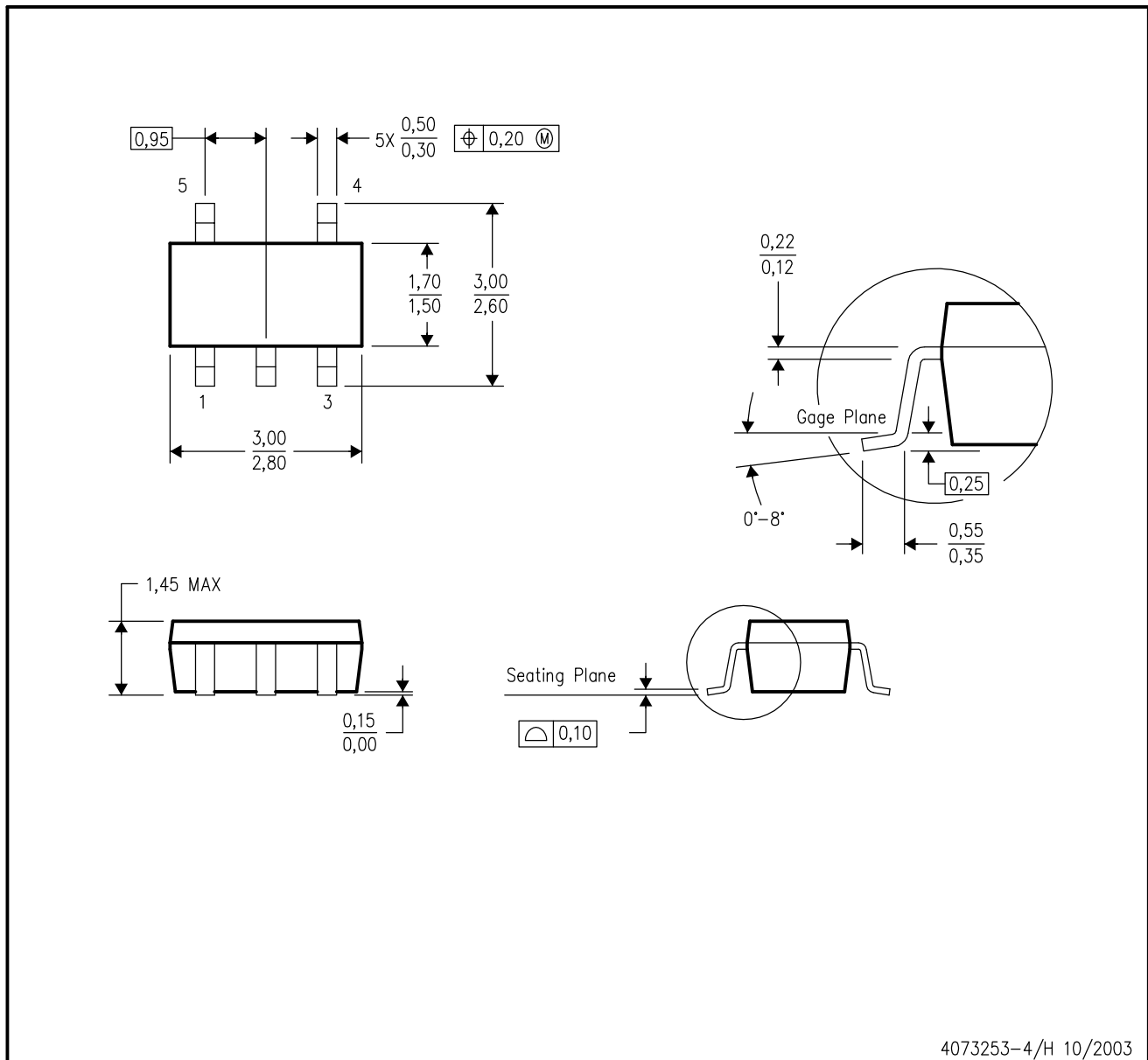

- NOTES:
- A. All linear dimensions are in millimeters.
  - B. This drawing is subject to change without notice.
  - C. Body dimensions do not include mold flash or protrusion.
  - D. Falls within JEDEC MO-178 Variation AA.

DBV (R-PDSO-G6)

PLASTIC SMALL-OUTLINE PACKAGE

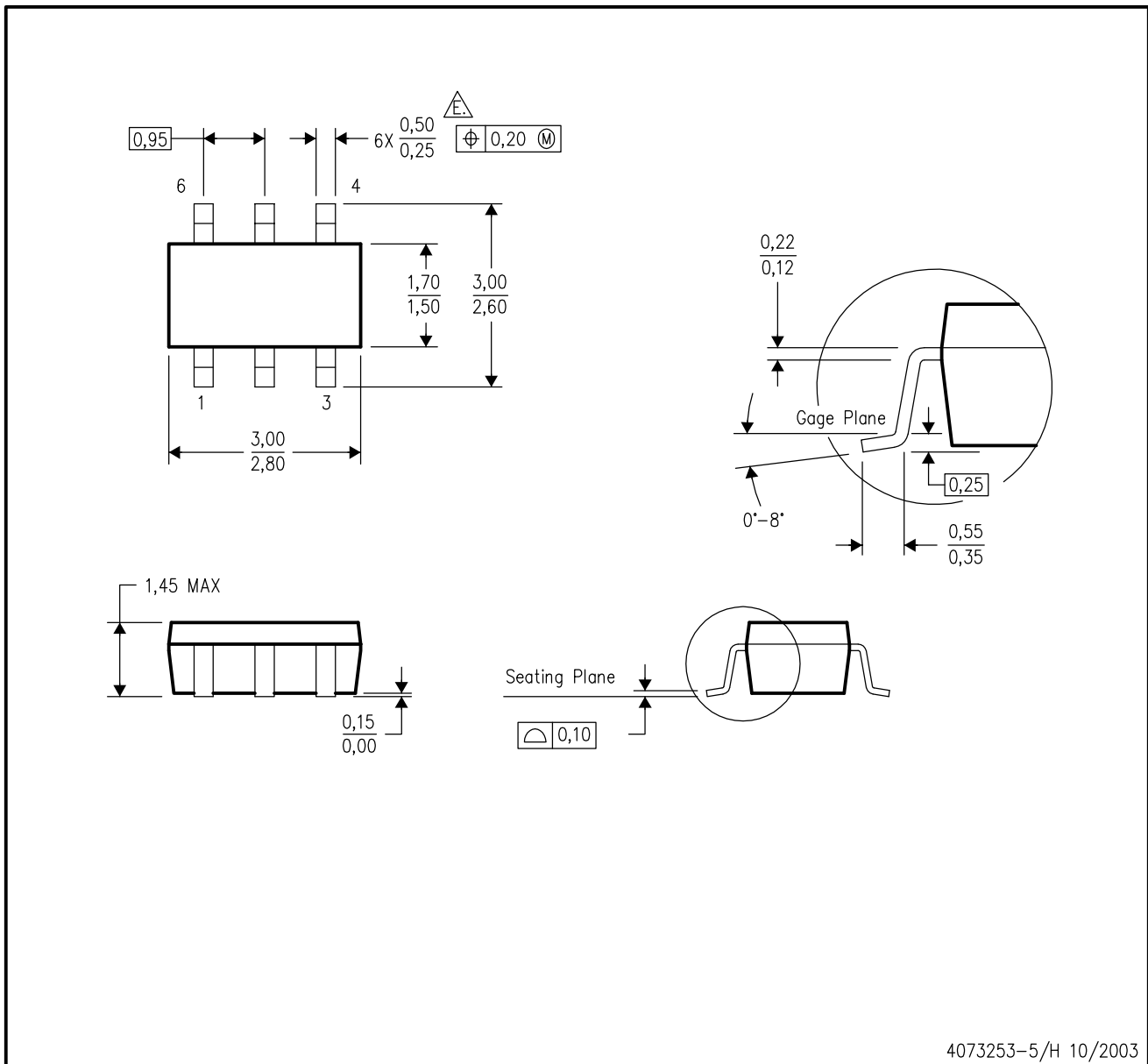

- NOTES:
- A. All linear dimensions are in millimeters.
  - B. This drawing is subject to change without notice.
  - C. Body dimensions do not include mold flash or protrusion.
  - D. Leads 1,2,3 may be wider than leads 4,5,6 for package orientation.
  - $\triangle$  Falls within JEDEC MO-178 Variation AB, except minimum lead width.

DGQ (S-PDSO-G10)

PowerPAD™ PLASTIC SMALL-OUTLINE PACKAGE

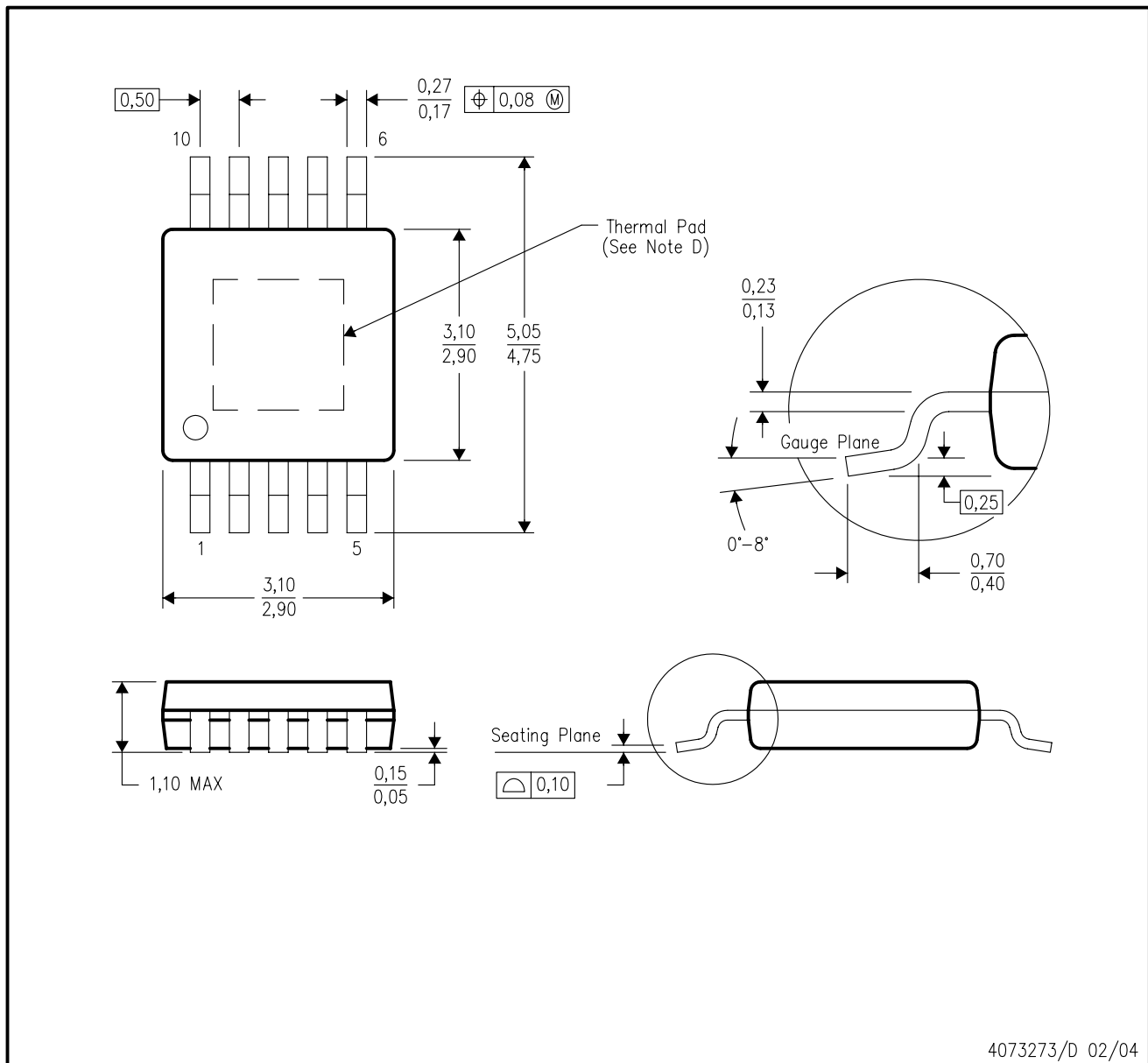

- NOTES:
- All linear dimensions are in millimeters.
  - This drawing is subject to change without notice.
  - Body dimensions do not include mold flash or protrusion.
  - This package is designed to be soldered to a thermal pad on the board. Refer to Technical Brief, PowerPAD Thermally Enhanced Package, Texas Instruments Literature No. SLMA002 for information regarding recommended board layout. This document is available at [www.ti.com](http://www.ti.com) <<http://www.ti.com>>.
  - Falls within JEDEC MO-187 variation BA-T.

PowerPAD is a trademark of Texas Instruments.

DGN (S-PDSO-G8)

PowerPAD™ PLASTIC SMALL-OUTLINE PACKAGE

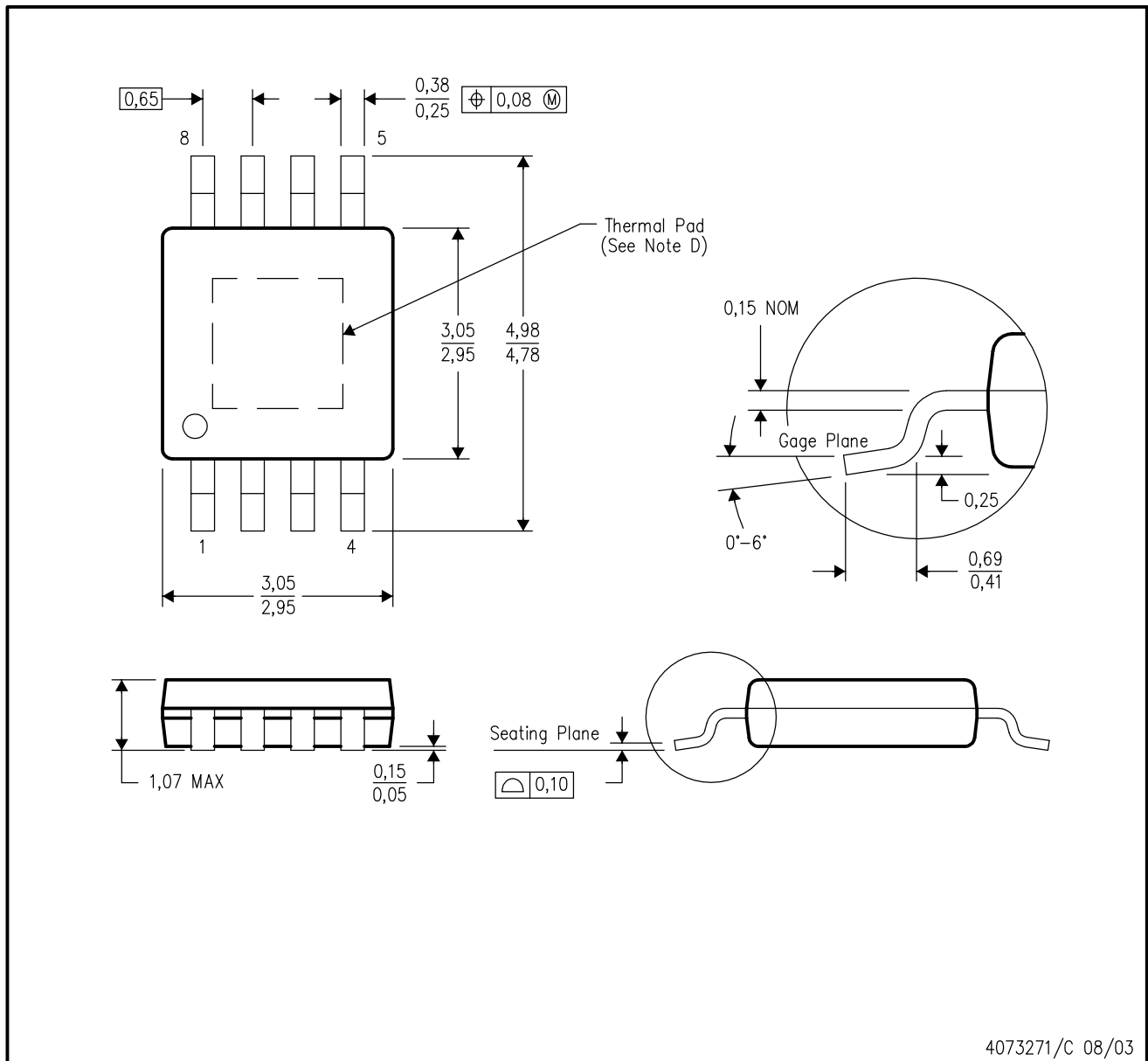

4073271/C 08/03

- NOTES:
- All linear dimensions are in millimeters.
  - This drawing is subject to change without notice.
  - Body dimensions do not include mold flash or protrusion.
  - This package is designed to be soldered to a thermal pad on the board. Refer to Technical Brief, PowerPad Thermally Enhanced Package, Texas Instruments Literature No. SLMA002 for information regarding recommended board layout. This document is available at [www.ti.com](http://www.ti.com) <<http://www.ti.com>>.
  - Falls within JEDEC MO-187

PowerPAD is a trademark of Texas Instruments.

D (R-PDSO-G\*\*)

PLASTIC SMALL-OUTLINE PACKAGE

8 PINS SHOWN



- NOTES: A. All linear dimensions are in inches (millimeters).  
 B. This drawing is subject to change without notice.  
 C. Body dimensions do not include mold flash or protrusion, not to exceed 0.006 (0,15).  
 D. Falls within JEDEC MS-012

PW (R-PDSO-G\*\*)

PLASTIC SMALL-OUTLINE PACKAGE

14 PINS SHOWN



4040064/F 01/97

- NOTES: A. All linear dimensions are in millimeters.  
 B. This drawing is subject to change without notice.  
 C. Body dimensions do not include mold flash or protrusion not to exceed 0,15.  
 D. Falls within JEDEC MO-153



## IMPORTANT NOTICE

Texas Instruments Incorporated and its subsidiaries (TI) reserve the right to make corrections, modifications, enhancements, improvements, and other changes to its products and services at any time and to discontinue any product or service without notice. Customers should obtain the latest relevant information before placing orders and should verify that such information is current and complete. All products are sold subject to TI's terms and conditions of sale supplied at the time of order acknowledgment.

TI warrants performance of its hardware products to the specifications applicable at the time of sale in accordance with TI's standard warranty. Testing and other quality control techniques are used to the extent TI deems necessary to support this warranty. Except where mandated by government requirements, testing of all parameters of each product is not necessarily performed.

TI assumes no liability for applications assistance or customer product design. Customers are responsible for their products and applications using TI components. To minimize the risks associated with customer products and applications, customers should provide adequate design and operating safeguards.

TI does not warrant or represent that any license, either express or implied, is granted under any TI patent right, copyright, mask work right, or other TI intellectual property right relating to any combination, machine, or process in which TI products or services are used. Information published by TI regarding third-party products or services does not constitute a license from TI to use such products or services or a warranty or endorsement thereof. Use of such information may require a license from a third party under the patents or other intellectual property of the third party, or a license from TI under the patents or other intellectual property of TI.

Reproduction of information in TI data books or data sheets is permissible only if reproduction is without alteration and is accompanied by all associated warranties, conditions, limitations, and notices. Reproduction of this information with alteration is an unfair and deceptive business practice. TI is not responsible or liable for such altered documentation.

Resale of TI products or services with statements different from or beyond the parameters stated by TI for that product or service voids all express and any implied warranties for the associated TI product or service and is an unfair and deceptive business practice. TI is not responsible or liable for any such statements.

Following are URLs where you can obtain information on other Texas Instruments products and application solutions:

<b>Products</b>		<b>Applications</b>	
Amplifiers	<a href="http://amplifier.ti.com">amplifier.ti.com</a>	Audio	<a href="http://www.ti.com/audio">www.ti.com/audio</a>
Data Converters	<a href="http://dataconverter.ti.com">dataconverter.ti.com</a>	Automotive	<a href="http://www.ti.com/automotive">www.ti.com/automotive</a>
DSP	<a href="http://dsp.ti.com">dsp.ti.com</a>	Broadband	<a href="http://www.ti.com/broadband">www.ti.com/broadband</a>
Interface	<a href="http://interface.ti.com">interface.ti.com</a>	Digital Control	<a href="http://www.ti.com/digitalcontrol">www.ti.com/digitalcontrol</a>
Logic	<a href="http://logic.ti.com">logic.ti.com</a>	Military	<a href="http://www.ti.com/military">www.ti.com/military</a>
Power Mgmt	<a href="http://power.ti.com">power.ti.com</a>	Optical Networking	<a href="http://www.ti.com/opticalnetwork">www.ti.com/opticalnetwork</a>
Microcontrollers	<a href="http://microcontroller.ti.com">microcontroller.ti.com</a>	Security	<a href="http://www.ti.com/security">www.ti.com/security</a>
		Telephony	<a href="http://www.ti.com/telephony">www.ti.com/telephony</a>
		Video & Imaging	<a href="http://www.ti.com/video">www.ti.com/video</a>
		Wireless	<a href="http://www.ti.com/wireless">www.ti.com/wireless</a>

Mailing Address: Texas Instruments  
Post Office Box 655303 Dallas, Texas 75265

Copyright © 2004, Texas Instruments Incorporated