

MC74HC245A

Octal 3-State Noninverting Bus Transceiver

High-Performance Silicon-Gate CMOS

The MC74HC245A is identical in pinout to the LS245. The device inputs are compatible with standard CMOS outputs; with pull-up resistors, they are compatible with LSTTL outputs.

The HC245A is a 3-state noninverting transceiver that is used for 2-way asynchronous communication between data buses. The device has an active-low Output Enable pin, which is used to place the I/O ports into high-impedance states. The Direction control determines whether data flows from A to B or from B to A.

Features

- Output Drive Capability: 15 LSTTL Loads
- Outputs Directly Interface to CMOS, NMOS, and TTL
- Operating Voltage Range: 2.0 to 6.0 V
- Low Input Current: 1 μ A
- High Noise Immunity Characteristic of CMOS Devices
- In Compliance with the Requirements Defined by JEDEC Standard No. 7A
- Moisture Sensitivity: MSL1 for All Packages
- Chip Complexity: 308 FETs or 77 Equivalent Gates
- Pb-Free Packages are Available*



ON Semiconductor®

<http://onsemi.com>

MARKING DIAGRAMS

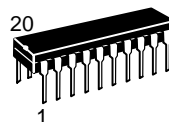

PDIP-20
N SUFFIX
CASE 738

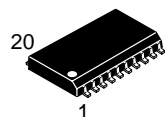
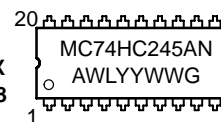

SOIC-20
DW SUFFIX
CASE 751D

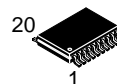
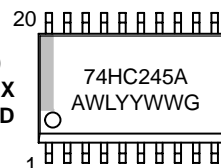

TSSOP-20
DT SUFFIX
CASE 948E

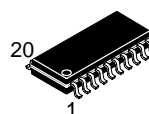
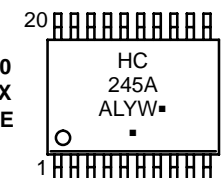

SOEIAJ-20
F SUFFIX
CASE 967

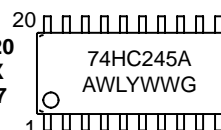

A = Assembly Location
WL, L = Wafer Lot
YY, Y = Year
WW, W = Work Week
G = Pb-Free Package
▪ = Pb-Free Package
(Note: Microdot may be in either location)

ORDERING INFORMATION

See detailed ordering and shipping information in the package dimensions section on page 2 of this data sheet.

*For additional information on our Pb-Free strategy and soldering details, please download the ON Semiconductor Soldering and Mounting Techniques Reference Manual, SOLDERRM/D.

MC74HC245A

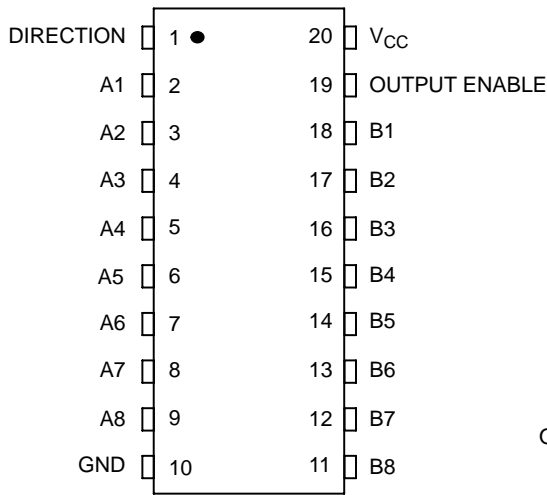

Figure 1. Pin Assignment

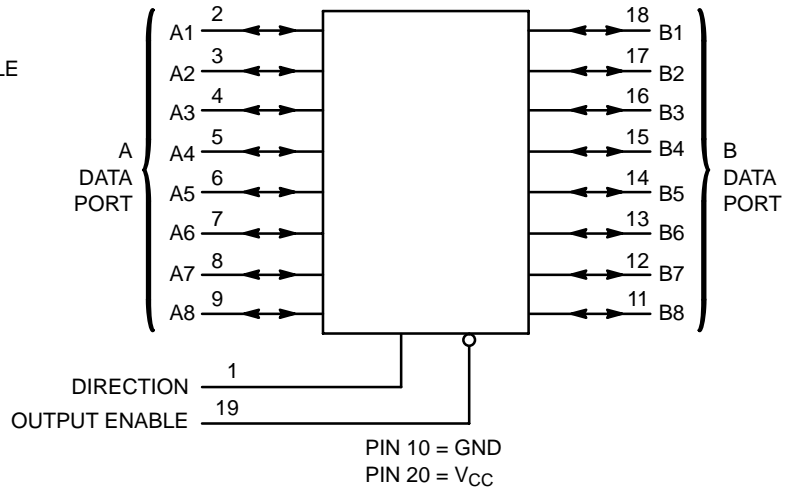

Figure 2. Logic Diagram

FUNCTION TABLE

Control Inputs		Operation
Output Enable	Direction	
L	L	Data Transmitted from Bus B to Bus A
L	H	Data Transmitted from Bus A to Bus B
H	X	Buses Isolated (High-Impedance State)

X = don't care

ORDERING INFORMATION

Device	Package	Shipping†
MC74HC245AN	PDIP-20	18 Units / Rail
MC74HC245ANG	PDIP-20 (Pb-Free)	18 Units / Rail
MC74HC245ADW	SOIC-20 WIDE	38 Units / Rail
MC74HC245ADWG	SOIC-20 WIDE (Pb-Free)	38 Units / Rail
MC74HC245ADWR2	SOIC-20 WIDE	1000 Tape & Reel
MC74HC245ADWR2G	SOIC-20 WIDE (Pb-Free)	1000 Tape & Reel
MC74HC245ADT	TSSOP-20*	75 Units / Rail
MC74HC245ADTG	TSSOP-20*	75 Units / Rail
MC74HC245ADTR2	TSSOP-20*	2500 Tape & Reel
MC74HC245ADTR2G	TSSOP-20*	2500 Tape & Reel
MC74HC245AF	SOEIAJ-20	40 Units / Rail
MC74HC245AFG	SOEIAJ-20 (Pb-Free)	40 Units / Rail
MC74HC245AFEL	SOEIAJ-20	2000 Tape & Reel
MC74HC245AFELG	SOEIAJ-20 (Pb-Free)	2000 Tape & Reel

†For information on tape and reel specifications, including part orientation and tape sizes, please refer to our Tape and Reel Packaging Specifications Brochure, BRD8011/D.

*This package is inherently Pb-Free.

MC74HC245A

MAXIMUM RATINGS (Note 1)

Symbol	Parameter	Value	Unit	
V _{CC}	DC Supply Voltage	-0.5 to +7.0	V	
V _{IN}	DC Input Voltage	-0.5 to V _{CC} +0.5	V	
V _{OUT}	DC Output Voltage (Note 2)	-0.5 to V _{CC} +0.5	V	
I _{IK}	DC Input Diode Current	±20	mA	
I _{OK}	DC Output Diode Current	±35	mA	
I _{OUT}	DC Output Sink Current	±35	mA	
I _{CC}	DC Supply Current per Supply Pin	±75	mA	
I _{GND}	DC Ground Current per Ground Pin	±75	mA	
T _{STG}	Storage Temperature Range	-65 to +150	°C	
T _L	Lead Temperature, 1 mm from Case for 10 Seconds	260	°C	
T _J	Junction Temperature Under Bias	+150	°C	
θ _{JA}	Thermal Resistance	PDIP SOIC TSSOP	67 96 128	°C/W
P _D	Power Dissipation in Still Air at 85°C	PDIP SOIC TSSOP	750 500 450	mW
MSL	Moisture Sensitivity	Level 1		
F _R	Flammability Rating	Oxygen Index: 30% to 35%	UL 94 V-0 @ 0.125 in	
V _{ESD}	ESD Withstand Voltage	Human Body Model (Note 3) Machine Model (Note 4) Charged Device Model (Note 5)	>2000 >200 >1000	V
I _{LATCHUP}	Latchup Performance	Above V _{CC} and Below GND at 85°C (Note 6)	±300	mA

Maximum ratings are those values beyond which device damage can occur. Maximum ratings applied to the device are individual stress limit values (not normal operating conditions) and are not valid simultaneously. If these limits are exceeded, device functional operation is not implied, damage may occur and reliability may be affected.

1. Measured with minimum pad spacing on an FR4 board, using 10 mm-by-1 inch, 20 ounce copper trace with no air flow.
2. I_O absolute maximum rating must be observed.
3. Tested to EIA/JESD22-A114-A.
4. Tested to EIA/JESD22-A115-A.
5. Tested to JESD22-C101-A.
6. Tested to EIA/JESD78.

RECOMMENDED OPERATING CONDITIONS

Symbol	Parameter	Min	Max	Unit
V _{CC}	DC Supply Voltage (Referenced to GND)	2.0	6.0	V
V _{in} , V _{out}	DC Input Voltage, Output Voltage (Referenced to GND)	0	V _{CC}	V
T _A	Operating Temperature, All Package Types	-55	+125	°C
t _r , t _f	Input Rise and Fall Time (Figure 3)			ns
		V _{CC} = 2.0 V	0	1000
		V _{CC} = 4.5 V	0	500
		V _{CC} = 6.0 V	0	400

MC74HC245A

DC ELECTRICAL CHARACTERISTICS (Voltages Referenced to GND)

Symbol	Parameter	Test Conditions	V _{CC} V	Guaranteed Limit			Unit				
				-55 to 25°C	≤ 85°C	≤ 125°C					
V _{IH}	Minimum High-Level Input Voltage	V _{out} = V _{CC} - 0.1 V I _{out} ≤ 20 μA	2.0	1.5	1.5	1.5	V				
			3.0	2.1	2.1	2.1					
			4.5	3.15	3.15	3.15					
			6.0	4.2	4.2	4.2					
V _{IL}	Maximum Low-Level Input Voltage	V _{out} = 0.1 V I _{out} ≤ 20 μA	2.0	0.5	0.5	0.5	V				
			3.0	0.9	0.9	0.9					
			4.5	1.35	1.35	1.35					
			6.0	1.8	1.8	1.8					
V _{OH}	Minimum High-Level Output Voltage	V _{in} = V _{IH} I _{out} ≤ 20 μA	2.0	1.9	1.9	1.9	V				
			4.5	4.4	4.4	4.4					
			6.0	5.9	5.9	5.9					
		V _{in} = V _{IH} I _{out} ≤ 2.4 mA	3.0	2.48	2.34	2.2					
			4.5	3.98	3.84	3.7					
V _{OL}	Maximum Low-Level Output Voltage	V _{in} = V _{IL} I _{out} ≤ 20 μA	2.0	0.1	0.1	0.1	V				
			4.5	0.1	0.1	0.1					
			6.0	0.1	0.1	0.1					
		V _{in} = V _{IL} I _{out} ≤ 2.4 mA	3.0	0.26	0.33	0.4					
			4.5	0.26	0.33	0.4					
I _{in}	Maximum Input Leakage Current	V _{in} = V _{CC} or GND	6.0	± 0.1	± 1.0	± 1.0	μA				
			I _{oZ}	Maximum Three-State Leakage Current	Output in High-Impedance State V _{in} = V _{IL} or V _{IH} V _{out} = V _{CC} or GND	6.0		± 0.5	± 5.0	± 10	μA
						I _{CC}		Maximum Quiescent Supply Current (per Package)	V _{in} = V _{CC} or GND I _{out} = 0 μA	6.0	

7. Information on typical parametric values and high frequency or heavy load considerations can be found in the ON Semiconductor High-Speed CMOS Data Book (DL129/D).

AC ELECTRICAL CHARACTERISTICS (C_L = 50 pF, Input t_r = t_f = 6 ns)

Symbol	Parameter	V _{CC} V	Guaranteed Limit			Unit
			-55 to 25°C	≤ 85°C	≤ 125°C	
t _{PLH} , t _{PHL}	Maximum Propagation Delay, A to B, B to A (Figures 1 and 3)	2.0	75	95	110	ns
		3.0	55	70	80	
		4.5	15	19	22	
		6.0	13	16	19	
t _{PLZ} , t _{PHZ}	Maximum Propagation Delay, Direction or Output Enable to A or B (Figures 2 and 4)	2.0	110	140	165	ns
		3.0	90	110	130	
		4.5	22	28	33	
		6.0	19	24	28	
t _{PZL} , t _{PZH}	Maximum Propagation Delay, Output Enable to A or B (Figures 2 and 4)	2.0	110	140	165	ns
		3.0	90	110	130	
		4.5	22	28	33	
		6.0	19	24	28	
t _{TLH} , t _{THL}	Maximum Output Transition Time, Any Output (Figures 1 and 3)	2.0	60	75	90	ns
		3.0	23	27	32	
		4.5	12	15	18	
		6.0	10	13	15	
C _{in}	Maximum Input Capacitance (Pin 1 or Pin 19)	-	10	10	10	pF
C _{out}	Maximum Three-State I/O Capacitance (I/O in High-Impedance State)	-	15	15	15	pF

8. For propagation delays with loads other than 50 pF, and information on typical parametric values, see the ON Semiconductor High-Speed CMOS Data Book (DL129/D).

C _{PD}	Power Dissipation Capacitance (Per Transceiver Channel) (Note 9)	Typical @ 25°C, V _{CC} = 5.0 V	
		40	pF

9. Used to determine the no-load dynamic power consumption: P_D = C_{PD} V_{CC}²f + I_{CC} V_{CC}. For load considerations, see the ON Semiconductor High-Speed CMOS Data Book (DL129/D).

MC74HC245A

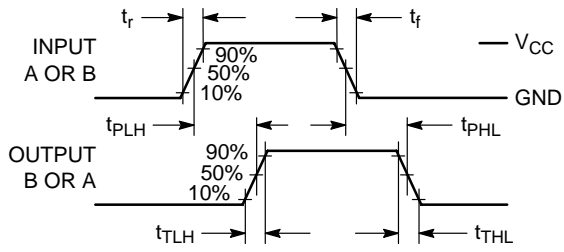

Figure 3. Switching Waveform

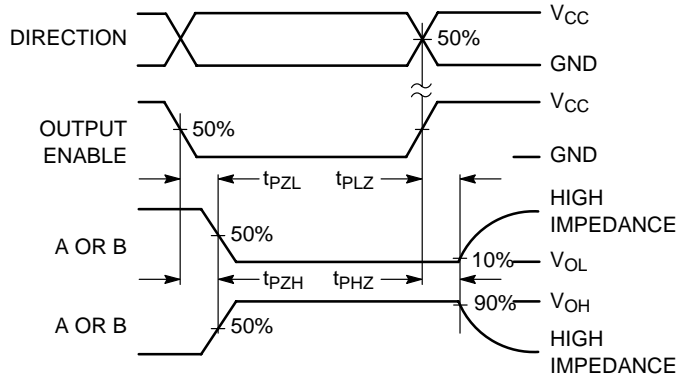
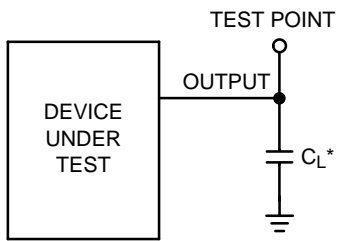
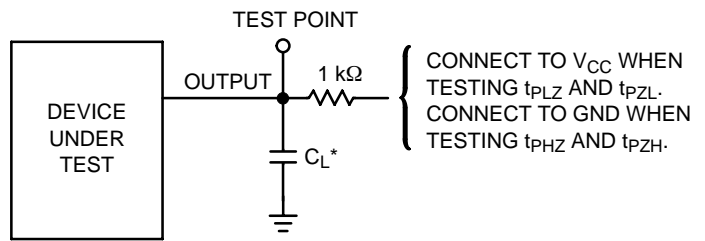

Figure 4. Switching Waveform



*Includes all probe and jig capacitance

Figure 5. Test Circuit



*Includes all probe and jig capacitance

Figure 6. Test Circuit

MC74HC245A

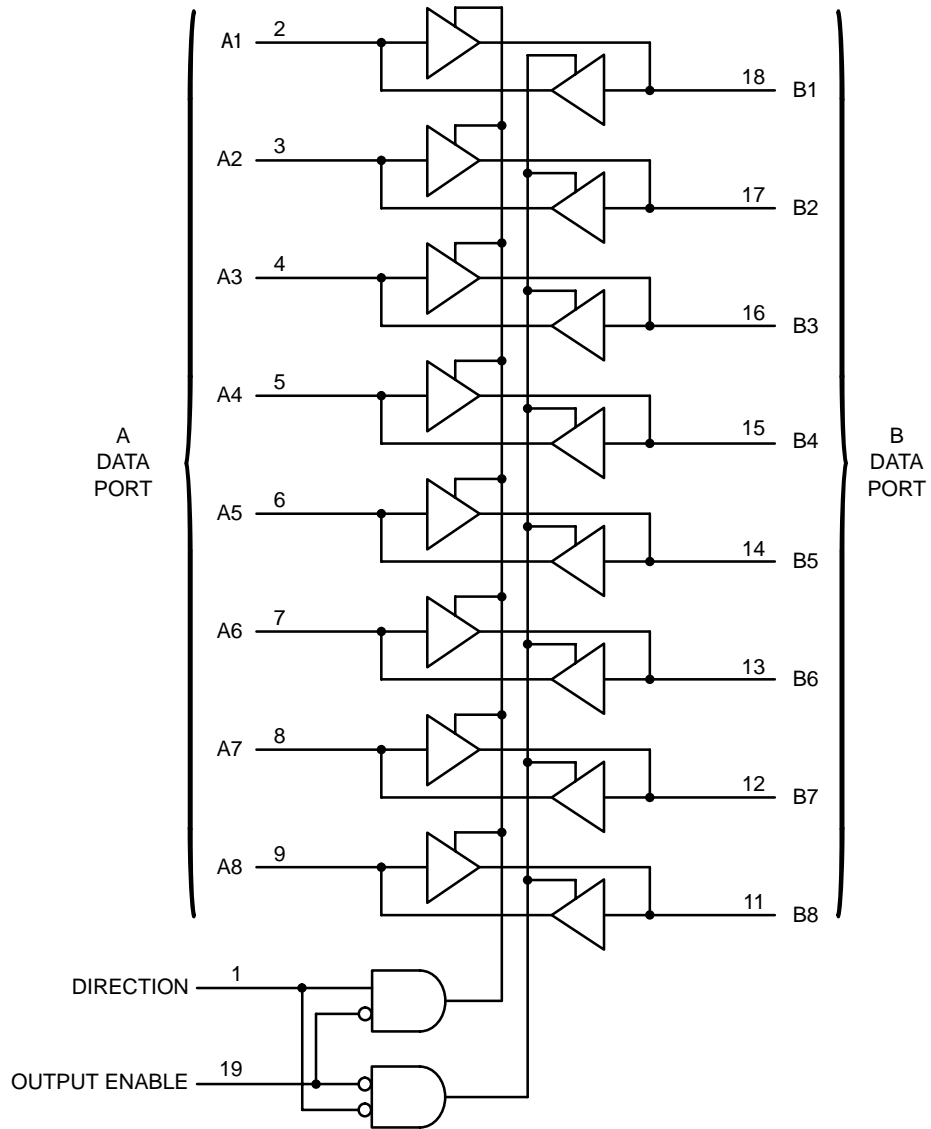
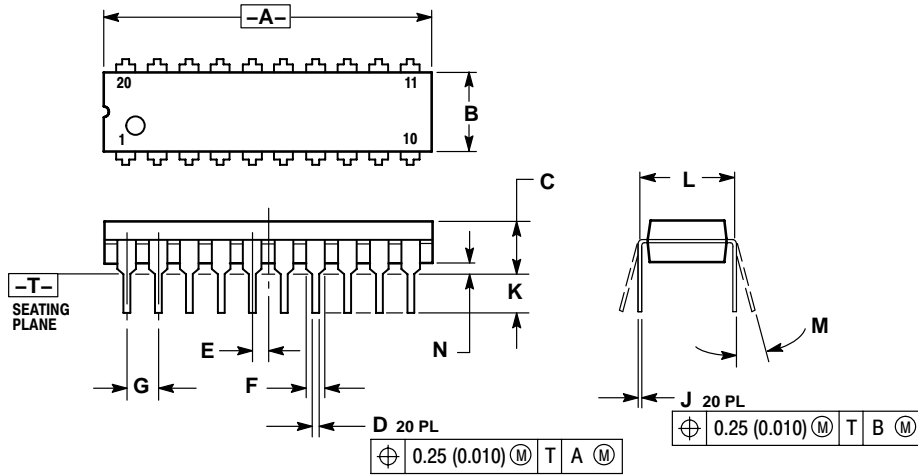

Figure 7. Expanded Logic Diagram

MC74HC245A

PACKAGE DIMENSIONS

PDIP-20
N SUFFIX
PLASTIC DIP PACKAGE
CASE 738-03
ISSUE E



- NOTES:
1. DIMENSIONING AND TOLERANCING PER ANSI Y14.5M, 1982.
 2. CONTROLLING DIMENSION: INCH.
 3. DIMENSION L TO CENTER OF LEAD WHEN FORMED PARALLEL.
 4. DIMENSION B DOES NOT INCLUDE MOLD FLASH.

DIM	INCHES		MILLIMETERS	
	MIN	MAX	MIN	MAX
A	1.010	1.070	25.66	27.17
B	0.240	0.260	6.10	6.60
C	0.150	0.180	3.81	4.57
D	0.015	0.022	0.39	0.55
E	0.050 BSC		1.27 BSC	
F	0.050		1.27	
G	0.100 BSC		2.54 BSC	
J	0.008	0.015	0.21	0.38
K	0.110	0.140	2.80	3.55
L	0.300 BSC		7.62 BSC	
M	0° 15°		0° 15°	
N	0.020	0.040	0.51	1.01

SOIC-20
DW SUFFIX
CASE 751D-05
ISSUE G

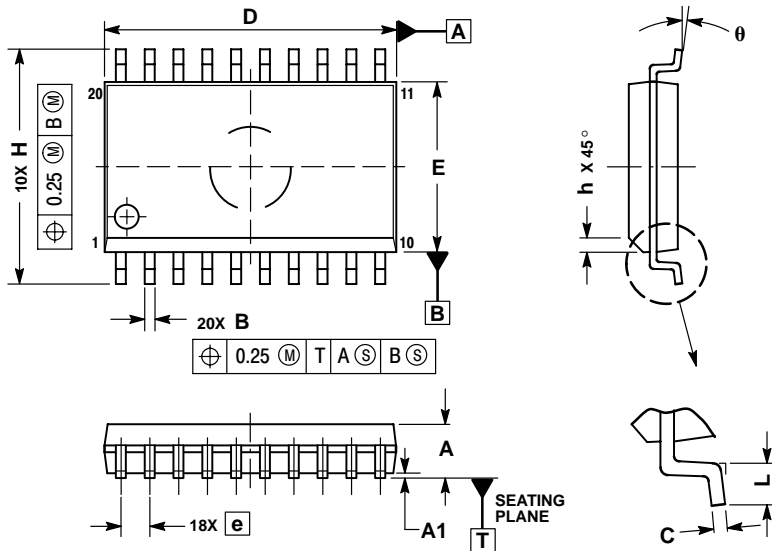

- NOTES:
1. DIMENSIONS ARE IN MILLIMETERS.
 2. INTERPRET DIMENSIONS AND TOLERANCES PER ASME Y14.5M, 1994.
 3. DIMENSIONS D AND E DO NOT INCLUDE MOLD PROTRUSION.
 4. MAXIMUM MOLD PROTRUSION 0.15 PER SIDE.
 5. DIMENSION B DOES NOT INCLUDE DAMBAR PROTRUSION. ALLOWABLE PROTRUSION SHALL BE 0.13 TOTAL IN EXCESS OF B DIMENSION AT MAXIMUM MATERIAL CONDITION.

DIM	MILLIMETERS	
	MIN	MAX
A	2.35	2.65
A1	0.10	0.25
B	0.35	0.49
C	0.23	0.32
D	12.65	12.95
E	7.40	7.60
e	1.27 BSC	
H	10.05	10.55
h	0.25	0.75
L	0.50	0.90
theta	0° 7°	

MC74HC245A

PACKAGE DIMENSIONS

TSSOP-20
DT SUFFIX
CASE 948E-02
ISSUE B

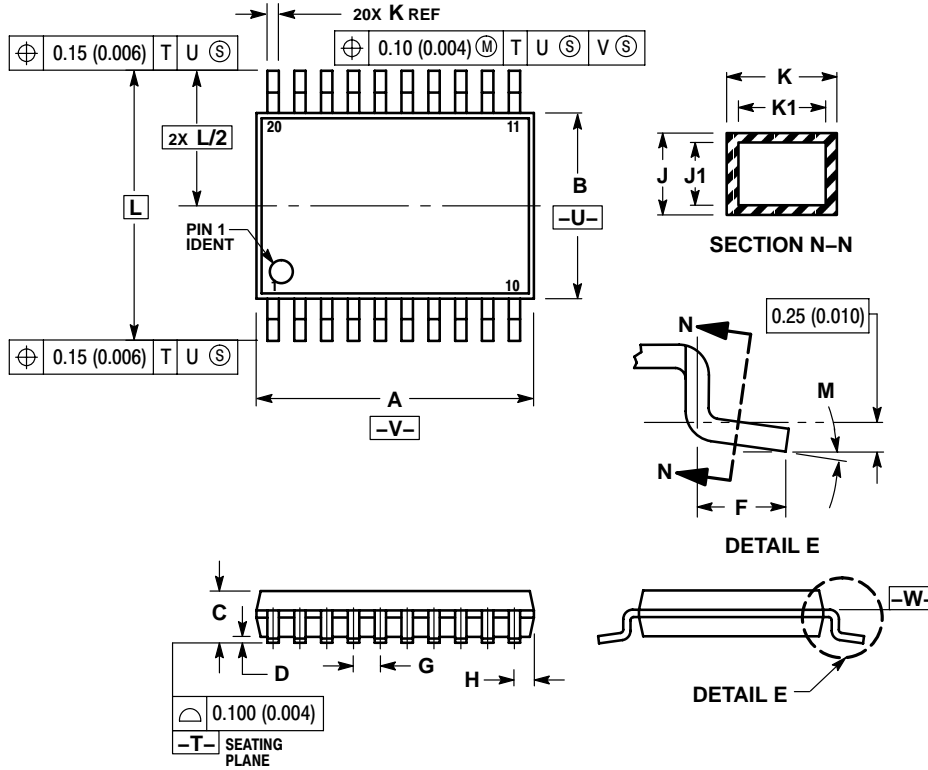

NOTES:

1. DIMENSIONING AND TOLERANCING PER ANSI Y14.5M, 1982.
2. CONTROLLING DIMENSION: MILLIMETER.
3. DIMENSION A DOES NOT INCLUDE MOLD FLASH, PROTRUSIONS OR GATE BURRS. MOLD FLASH OR GATE BURRS SHALL NOT EXCEED 0.15 (0.006) PER SIDE.
4. DIMENSION B DOES NOT INCLUDE INTERLEAD FLASH OR PROTRUSION. INTERLEAD FLASH OR PROTRUSION SHALL NOT EXCEED 0.25 (0.010) PER SIDE.
5. DIMENSION K DOES NOT INCLUDE DAMBAR PROTRUSION. ALLOWABLE DAMBAR PROTRUSION SHALL BE 0.08 (0.003) TOTAL IN EXCESS OF THE K DIMENSION AT MAXIMUM MATERIAL CONDITION.
6. TERMINAL NUMBERS ARE SHOWN FOR REFERENCE ONLY.
7. DIMENSION A AND B ARE TO BE DETERMINED AT DATUM PLANE -W-.

DIM	MILLIMETERS		INCHES	
	MIN	MAX	MIN	MAX
A	6.40	6.60	0.252	0.260
B	4.30	4.50	0.169	0.177
C	---	1.20	---	0.047
D	0.05	0.15	0.002	0.006
F	0.50	0.75	0.020	0.030
G	0.65 BSC		0.026 BSC	
H	0.27	0.37	0.011	0.015
J	0.09	0.20	0.004	0.008
J1	0.09	0.16	0.004	0.006
K	0.19	0.30	0.007	0.012
K1	0.19	0.25	0.007	0.010
L	6.40 BSC		0.252 BSC	
M	0°	8°	0°	8°

MC74HC245A

PACKAGE DIMENSIONS

SOEIAJ-20
F SUFFIX
CASE 967-01
ISSUE O

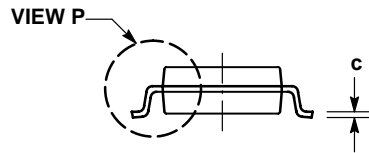
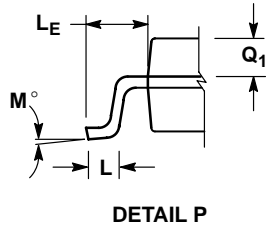
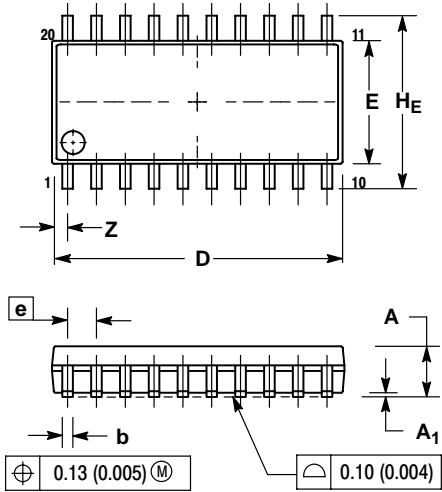

NOTES:

1. DIMENSIONING AND TOLERANCING PER ANSI Y14.5M, 1982.
2. CONTROLLING DIMENSION: MILLIMETER.
3. DIMENSIONS D AND E DO NOT INCLUDE MOLD FLASH OR PROTRUSIONS AND ARE MEASURED AT THE PARTING LINE. MOLD FLASH OR PROTRUSIONS SHALL NOT EXCEED 0.15 (0.006) PER SIDE.
4. TERMINAL NUMBERS ARE SHOWN FOR REFERENCE ONLY.
5. THE LEAD WIDTH DIMENSION (b) DOES NOT INCLUDE DAMBAR PROTRUSION. ALLOWABLE DAMBAR PROTRUSION SHALL BE 0.08 (0.003) TOTAL IN EXCESS OF THE LEAD WIDTH DIMENSION AT MAXIMUM MATERIAL CONDITION. DAMBAR CANNOT BE LOCATED ON THE LOWER RADIUS OR THE FOOT. MINIMUM SPACE BETWEEN PROTRUSIONS AND ADJACENT LEAD TO BE 0.46 (0.018).

DIM	MILLIMETERS		INCHES	
	MIN	MAX	MIN	MAX
A	---	2.05	---	0.081
A ₁	0.05	0.20	0.002	0.008
b	0.35	0.50	0.014	0.020
c	0.18	0.27	0.007	0.011
D	12.35	12.80	0.486	0.504
E	5.10	5.45	0.201	0.215
e	1.27 BSC		0.050 BSC	
HE	7.40	8.20	0.291	0.323
L	0.50	0.85	0.020	0.033
LE	1.10	1.50	0.043	0.059
M	0°	10°	0°	10°
Q ₁	0.70	0.90	0.028	0.035
Z	---	0.81	---	0.032

MC74HC245A

ON Semiconductor and  are registered trademarks of Semiconductor Components Industries, LLC (SCILLC). SCILLC reserves the right to make changes without further notice to any products herein. SCILLC makes no warranty, representation or guarantee regarding the suitability of its products for any particular purpose, nor does SCILLC assume any liability arising out of the application or use of any product or circuit, and specifically disclaims any and all liability, including without limitation special, consequential or incidental damages. "Typical" parameters which may be provided in SCILLC data sheets and/or specifications can and do vary in different applications and actual performance may vary over time. All operating parameters, including "Typicals" must be validated for each customer application by customer's technical experts. SCILLC does not convey any license under its patent rights nor the rights of others. SCILLC products are not designed, intended, or authorized for use as components in systems intended for surgical implant into the body, or other applications intended to support or sustain life, or for any other application in which the failure of the SCILLC product could create a situation where personal injury or death may occur. Should Buyer purchase or use SCILLC products for any such unintended or unauthorized application, Buyer shall indemnify and hold SCILLC and its officers, employees, subsidiaries, affiliates, and distributors harmless against all claims, costs, damages, and expenses, and reasonable attorney fees arising out of, directly or indirectly, any claim of personal injury or death associated with such unintended or unauthorized use, even if such claim alleges that SCILLC was negligent regarding the design or manufacture of the part. SCILLC is an Equal Opportunity/Affirmative Action Employer. This literature is subject to all applicable copyright laws and is not for resale in any manner.

PUBLICATION ORDERING INFORMATION

LITERATURE FULFILLMENT:

Literature Distribution Center for ON Semiconductor
P.O. Box 61312, Phoenix, Arizona 85082-1312 USA

Phone: 480-829-7710 or 800-344-3860 Toll Free USA/Canada

Fax: 480-829-7709 or 800-344-3867 Toll Free USA/Canada

Email: orderlit@onsemi.com

N. American Technical Support: 800-282-9855 Toll Free
USA/Canada

Japan: ON Semiconductor, Japan Customer Focus Center
2-9-1 Kamimeguro, Meguro-ku, Tokyo, Japan 153-0051
Phone: 81-3-5773-3850

ON Semiconductor Website: <http://onsemi.com>

Order Literature: <http://www.onsemi.com/litorder>

For additional information, please contact your
local Sales Representative.