

MMBZ5V6ALT1 Series

Preferred Device

24 and 40 Watt Peak Power Zener Transient Voltage Suppressors

SOT-23 Dual Common Anode Zeners for ESD Protection

These dual monolithic silicon Zener diodes are designed for applications requiring transient overvoltage protection capability. They are intended for use in voltage and ESD sensitive equipment such as computers, printers, business machines, communication systems, medical equipment and other applications. Their dual junction common anode design protects two separate lines using only one package. These devices are ideal for situations where board space is at a premium.

Features

- Pb-Free Packages are Available
- SOT-23 Package Allows Either Two Separate Unidirectional Configurations or a Single Bidirectional Configuration
- Working Peak Reverse Voltage Range – 3 V to 26 V
- Standard Zener Breakdown Voltage Range – 5.6 V to 33 V
- Peak Power – 24 or 40 Watts @ 1.0 ms (Unidirectional), per Figure 5 Waveform
- ESD Rating of Class N (exceeding 16 kV) per the Human Body Model
- Maximum Clamping Voltage @ Peak Pulse Current
- Low Leakage < 5.0 μ A
- Flammability Rating UL 94 V-O

Mechanical Characteristics

CASE: Void-free, transfer-molded, thermosetting plastic case

FINISH: Corrosion resistant finish, easily solderable

MAXIMUM CASE TEMPERATURE FOR SOLDERING PURPOSES:

260°C for 10 Seconds

Package designed for optimal automated board assembly

Small package size for high density applications

Available in 8 mm Tape and Reel

Use the Device Number to order the 7 inch/3,000 unit reel.

Replace the “T1” with “T3” in the Device Number to order the

13 inch/10,000 unit reel.



ON Semiconductor®

<http://onsemi.com>

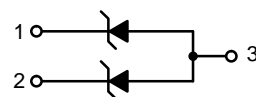

MARKING DIAGRAM

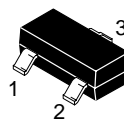

SOT-23
CASE 318
STYLE 12

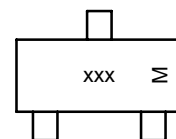

xxx = Device Code

M = Date Code

ORDERING INFORMATION

See detailed ordering and shipping information in the package dimensions section on page 2 of this data sheet.

DEVICE MARKING INFORMATION

See specific marking information in the device marking column of the table on page 3 of this data sheet.

Preferred devices are recommended choices for future use and best overall value.

MMBZ5V6ALT1 Series

MAXIMUM RATINGS

| Rating | Symbol | Value | Unit |
|---|-----------------|--------------|----------------------------|
| Peak Power Dissipation @ 1.0 ms (Note 1) MMBZ5V6ALT1 thru MMBZ10VALT1 @ $T_L \leq 25^\circ\text{C}$ MMBZ12VALT1 thru MMBZ33VALT1 | P_{pk} | 24 40 | Watts |
| Total Power Dissipation on FR-5 Board (Note 2) @ $T_A = 25^\circ\text{C}$ Derate above 25°C | P_D | 225 1.8 | mW mW/ $^\circ\text{C}$ |
| Thermal Resistance Junction-to-Ambient | $R_{\theta JA}$ | 556 | $^\circ\text{C}/\text{W}$ |
| Total Power Dissipation on Alumina Substrate (Note 3) @ $T_A = 25^\circ\text{C}$ Derate above 25°C | P_D | 300 2.4 | mW mW/ $^\circ\text{C}$ |
| Thermal Resistance Junction-to-Ambient | $R_{\theta JA}$ | 417 | $^\circ\text{C}/\text{W}$ |
| Junction and Storage Temperature Range | T_J, T_{stg} | - 55 to +150 | $^\circ\text{C}$ |
| Lead Solder Temperature – Maximum (10 Second Duration) | T_L | 260 | $^\circ\text{C}$ |

Maximum ratings are those values beyond which device damage can occur. Maximum ratings applied to the device are individual stress limit values (not normal operating conditions) and are not valid simultaneously. If these limits are exceeded, device functional operation is not implied, damage may occur and reliability may be affected.

1. Non-repetitive current pulse per Figure 5 and derate above $T_A = 25^\circ\text{C}$ per Figure 6.

2. FR-5 = 1.0 x 0.75 x 0.62 in.

3. Alumina = 0.4 x 0.3 x 0.024 in, 99.5% alumina.

*Other voltages may be available upon request.

ORDERING INFORMATION

| Device | Package | Shipping† |
|---------------|---------------------|--------------------|
| MMBZ5V6ALT1 | SOT-23 | 3000 Tape & Reel |
| MMBZ5V6ALT1G | SOT-23 (Pb-Free) | 3000 Tape & Reel |
| MMBZ5V6ALT3 | SOT-23 | 10,000 Tape & Reel |
| MMBZ5V6ALT3G | SOT-23 (Pb-Free) | 10,000 Tape & Reel |
| MMBZ6VxALT1 | SOT-23 | 3000 Tape & Reel |
| MMBZ6VxALT1G | SOT-23 (Pb-Free) | 3000 Tape & Reel |
| MMBZ6VxALT3 | SOT-23 | 10,000 Tape & Reel |
| MMBZ6VxALT3G | SOT-23 (Pb-Free) | 10,000 Tape & Reel |
| MMBZ9V1ALT1 | SOT-23 | 3000 Tape & Reel |
| MMBZ9V1ALT1G | SOT-23 (Pb-Free) | 3000 Tape & Reel |
| MMBZ9V1ALT3 | SOT-23 | 10,000 Tape & Reel |
| MMBZ9V1ALT13G | SOT-23 (Pb-Free) | 10,000 Tape & Reel |
| MMBZxxVALT1 | SOT-23 | 3000 Tape & Reel |
| MMBZxxVALT1G | SOT-23 (Pb-Free) | 3000 Tape & Reel |
| MMBZxxVALT3 | SOT-23 | 10,000 Tape & Reel |
| MMBZxxVALT3G | SOT-23 (Pb-Free) | 10,000 Tape & Reel |

†For information on tape and reel specifications, including part orientation and tape sizes, please refer to our Tape and Reel Packaging Specifications Brochure, BRD8011/D.

MMBZ5V6ALT1 Series

ELECTRICAL CHARACTERISTICS

($T_A = 25^\circ\text{C}$ unless otherwise noted)

UNIDIRECTIONAL (Circuit tied to Pins 1 and 3 or 2 and 3)

| Symbol | Parameter |
|-----------------|---|
| I_{PP} | Maximum Reverse Peak Pulse Current |
| V_C | Clamping Voltage @ I_{PP} |
| V_{RWM} | Working Peak Reverse Voltage |
| I_R | Maximum Reverse Leakage Current @ V_{RWM} |
| V_{BR} | Breakdown Voltage @ I_T |
| I_T | Test Current |
| ΘV_{BR} | Maximum Temperature Coefficient of V_{BR} |
| I_F | Forward Current |
| V_F | Forward Voltage @ I_F |
| Z_{ZT} | Maximum Zener Impedance @ I_{ZT} |
| I_{ZK} | Reverse Current |
| Z_{ZK} | Maximum Zener Impedance @ I_{ZK} |

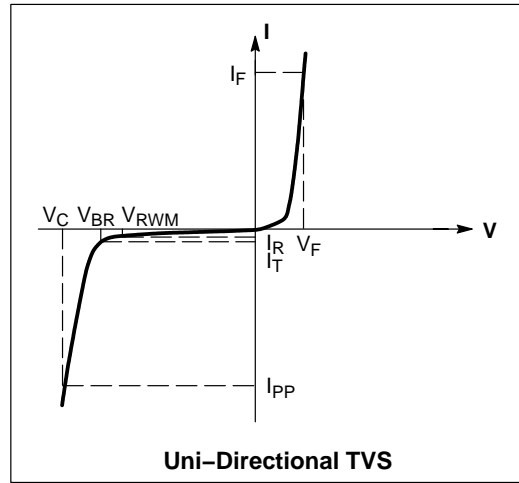

ELECTRICAL CHARACTERISTICS ($T_A = 25^\circ\text{C}$ unless otherwise noted)

UNIDIRECTIONAL (Circuit tied to Pins 1 and 3 or Pins 2 and 3)

($V_F = 0.9\text{ V Max @ } I_F = 10\text{ mA}$)

24 WATTS

| Device | Device Marking | V_{RWM} Volts | $I_R @$ V_{RWM} μA | Breakdown Voltage | | | | Max Zener Impedance (Note 5) | | | $V_C @ I_{PP}$ (Note 6) | | ΘV_{BR} $\text{mV}/^\circ\text{C}$ |
|-----------|----------------|--------------------|---------------------------------------|-----------------------|-----|------|---------------|------------------------------------|------------------------------------|------------|----------------------------|------|---|
| | | | | V_{BR} (Note 4) (V) | | | @ I_T mA | Z_{ZT} @ I_{ZT} Ω | Z_{ZK} @ I_{ZK} Ω | V_C V | I_{PP} A | | |
| | | | | Min | Nom | Max | | | | | | | |
| MMBZ5V6AL | 5A6 | 3.0 | 5.0 | 5.32 | 5.6 | 5.88 | 20 | 11 | 1600 | 0.25 | 8.0 | 3.0 | 1.26 |
| MMBZ6V2AL | 6A2 | 3.0 | 0.5 | 5.89 | 6.2 | 6.51 | 1.0 | - | - | - | 8.7 | 2.76 | 2.80 |
| MMBZ6V8AL | 6A8 | 4.5 | 0.5 | 6.46 | 6.8 | 7.14 | 1.0 | - | - | - | 9.6 | 2.5 | 3.4 |
| MMBZ9V1AL | 9A1 | 6.0 | 0.3 | 8.65 | 9.1 | 9.56 | 1.0 | - | - | - | 14 | 1.7 | 7.5 |
| MMBZ10VAL | 10A | 6.5 | 0.3 | 9.50 | 10 | 10.5 | 1.0 | - | - | - | 14.2 | 1.7 | 7.5 |

($V_F = 0.9\text{ V Max @ } I_F = 10\text{ mA}$)

40 WATTS

| Device | Device Marking | V_{RWM} Volts | $I_R @$ V_{RWM} nA | Breakdown Voltage | | | | $V_C @ I_{PP}$ (Note 6) | | ΘV_{BR} $\text{mV}/^\circ\text{C}$ |
|-----------|----------------|--------------------|----------------------------|-----------------------|-----|-------|---------------|-------------------------|---------------|---|
| | | | | V_{BR} (Note 4) (V) | | | @ I_T mA | V_C V | I_{PP} A | |
| | | | | Min | Nom | Max | | | | |
| MMBZ12VAL | 12A | 8.5 | 200 | 11.40 | 12 | 12.60 | 1.0 | 17 | 2.35 | 7.5 |
| MMBZ15VAL | 15A | 12 | 50 | 14.25 | 15 | 15.75 | 1.0 | 21 | 1.9 | 12.3 |
| MMBZ18VAL | 18A | 14.5 | 50 | 17.10 | 18 | 18.90 | 1.0 | 25 | 1.6 | 15.3 |
| MMBZ20VAL | 20A | 17 | 50 | 19.00 | 20 | 21.00 | 1.0 | 28 | 1.4 | 17.2 |
| MMBZ27VAL | 27A | 22 | 50 | 25.65 | 27 | 28.35 | 1.0 | 40 | 1.0 | 24.3 |
| MMBZ33VAL | 33A | 26 | 50 | 31.35 | 33 | 34.65 | 1.0 | 46 | 0.87 | 30.4 |

4. V_{BR} measured at pulse test current I_T at an ambient temperature of 25°C .

5. Z_{ZT} and Z_{ZK} are measured by dividing the AC voltage drop across the device by the AC current applied. The specified limits are for $I_{Z(AC)} = 0.1 I_{Z(DC)}$, with the AC frequency = 1.0 kHz.

6. Surge current waveform per Figure 5 and derate per Figure 6

MMBZ5V6ALT1 Series

TYPICAL CHARACTERISTICS

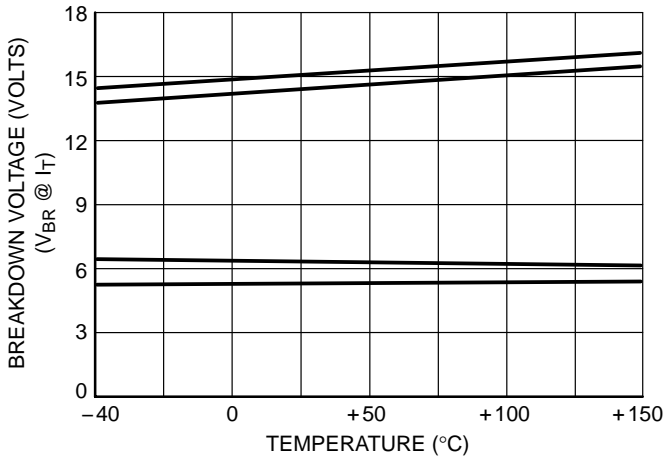

Figure 1. Typical Breakdown Voltage versus Temperature

(Upper curve for each voltage is bidirectional mode, lower curve is unidirectional mode)

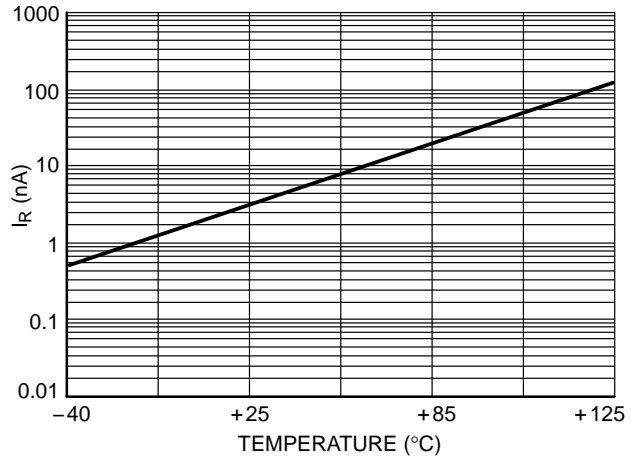

Figure 2. Typical Leakage Current versus Temperature

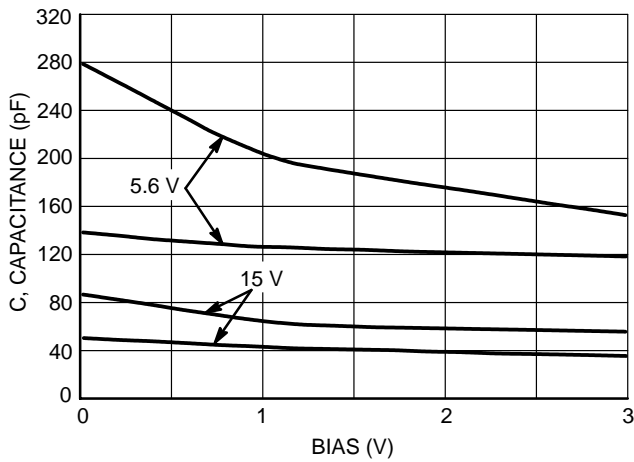

Figure 3. Typical Capacitance versus Bias Voltage

(Upper curve for each voltage is unidirectional mode, lower curve is bidirectional mode)

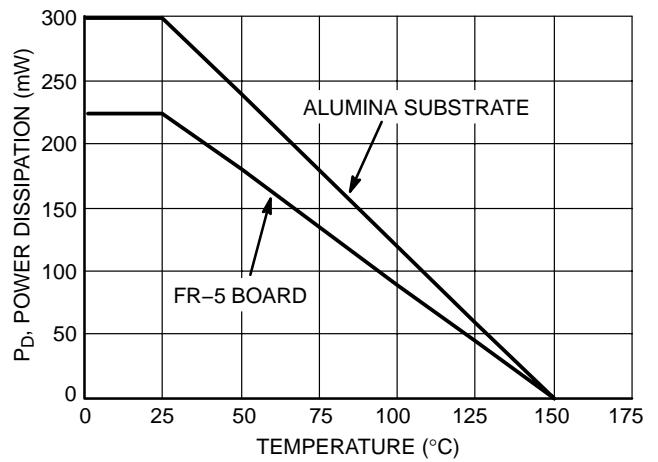

Figure 4. Steady State Power Derating Curve

MMBZ5V6ALT1 Series

TYPICAL CHARACTERISTICS

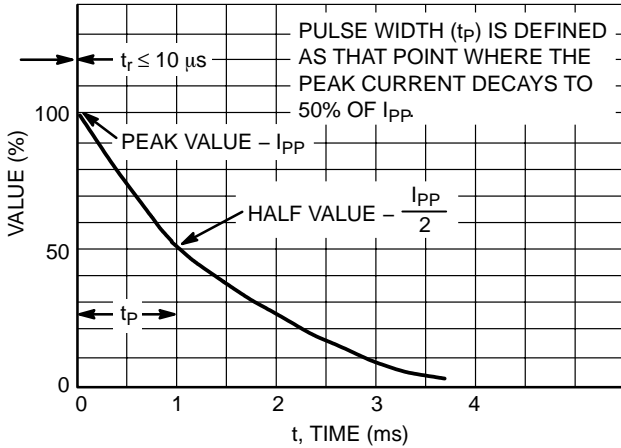

Figure 5. Pulse Waveform

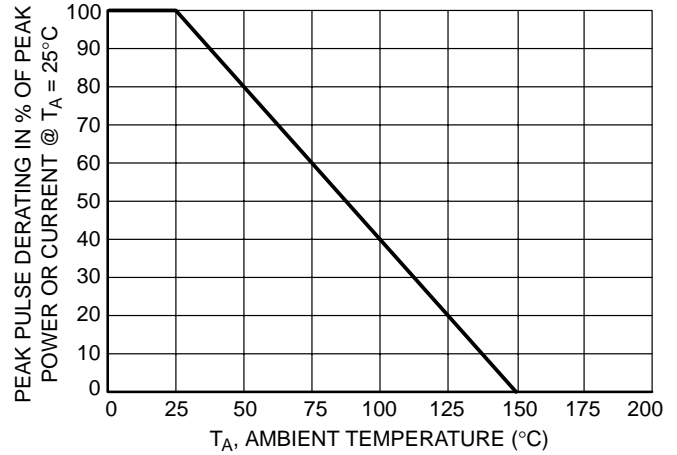

Figure 6. Pulse Derating Curve

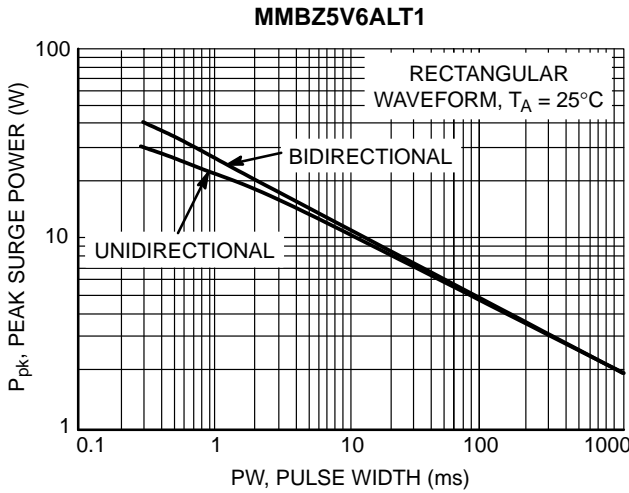

Figure 7. Maximum Non-repetitive Surge Power, P_{pk} versus PW

Power is defined as $V_{RSM} \times I_Z(pk)$ where V_{RSM} is the clamping voltage at $I_Z(pk)$.

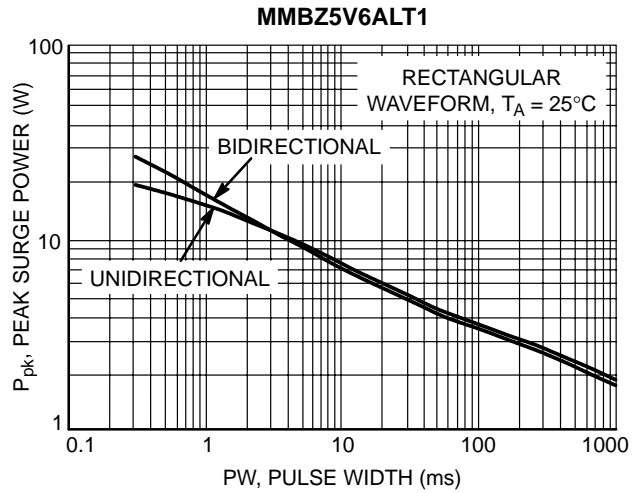

Figure 8. Maximum Non-repetitive Surge Power, $P_{pk(NOM)}$ versus PW

Power is defined as $V_Z(NOM) \times I_Z(pk)$ where $V_Z(NOM)$ is the nominal Zener voltage measured at the low test current used for voltage classification.

MMBZ5V6ALT1 Series

TYPICAL COMMON ANODE APPLICATIONS

A quad junction common anode design in a SOT-23 package protects four separate lines using only one package. This adds flexibility and creativity to PCB design especially

when board space is at a premium. Two simplified examples of TVS applications are illustrated below.

Computer Interface Protection

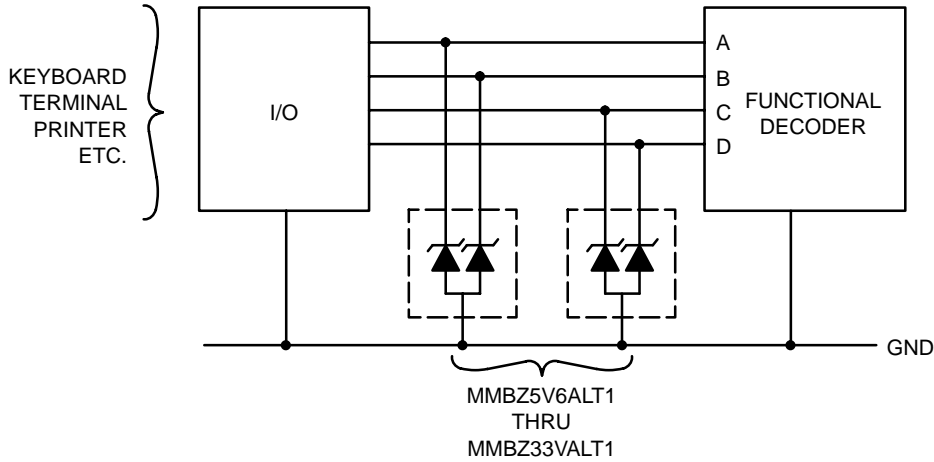

Microprocessor Protection

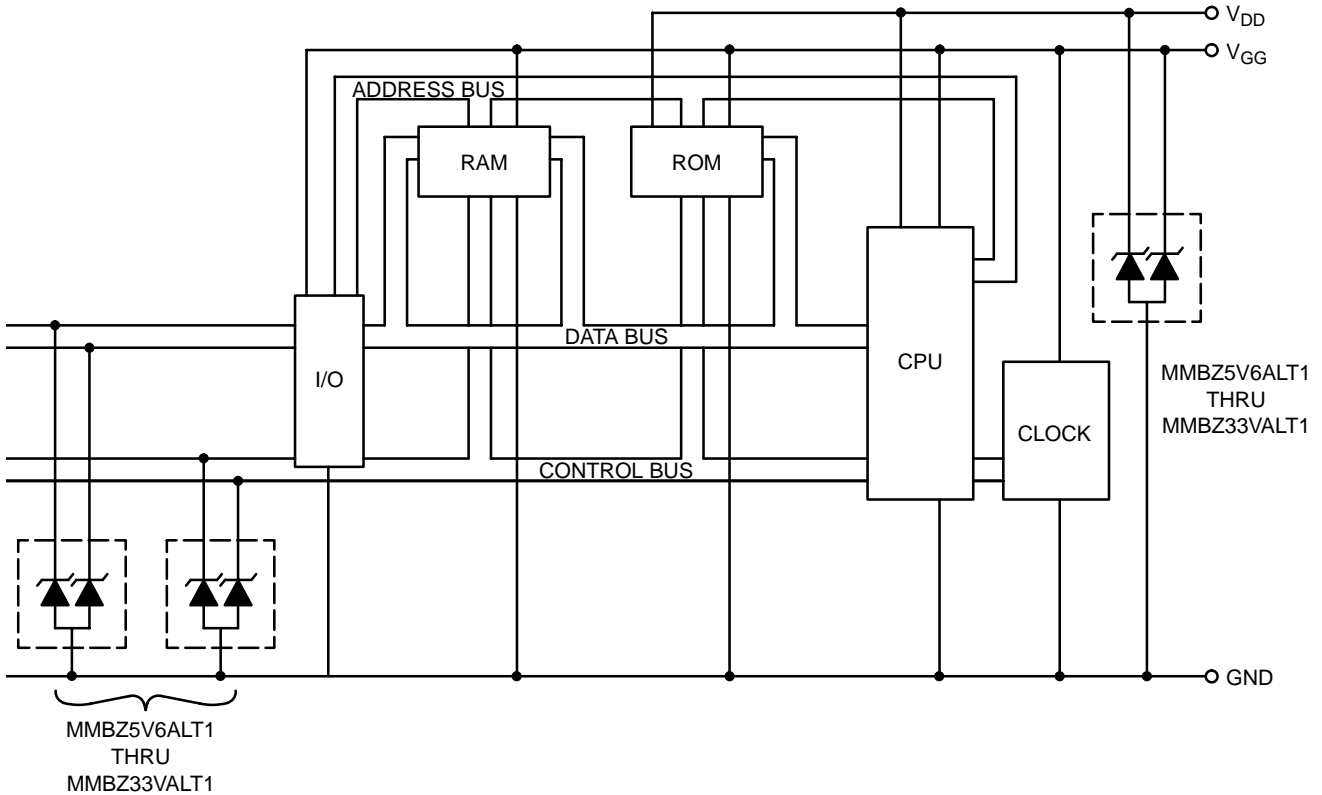

MMBZ5V6ALT1 Series

PACKAGE DIMENSIONS

SOT-23 (TO-236)
CASE 318-09
ISSUE AH

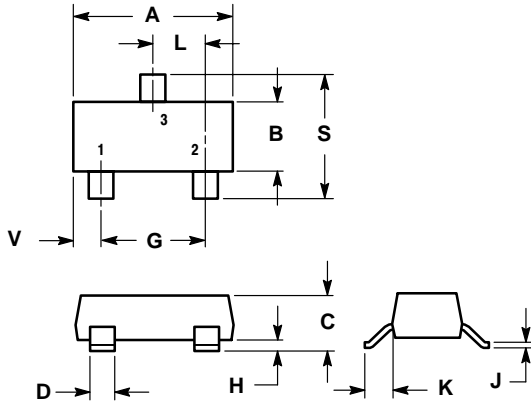

- NOTES:
1. DIMENSIONING AND TOLERANCING PER ANSI Y14.5M, 1982.
 2. CONTROLLING DIMENSION: INCH.
 3. MAXIMUM LEAD THICKNESS INCLUDES LEAD FINISH THICKNESS. MINIMUM LEAD THICKNESS IS THE MINIMUM THICKNESS OF BASE MATERIAL.
 4. 318-01, -02, AND -06 OBSOLETE, NEW STANDARD 318-09.

| DIM | INCHES | | MILLIMETERS | |
|-----|--------|--------|-------------|-------|
| | MIN | MAX | MIN | MAX |
| A | 0.1102 | 0.1197 | 2.80 | 3.04 |
| B | 0.0472 | 0.0551 | 1.20 | 1.40 |
| C | 0.0385 | 0.0498 | 0.99 | 1.26 |
| D | 0.0140 | 0.0200 | 0.36 | 0.50 |
| G | 0.0670 | 0.0826 | 1.70 | 2.10 |
| H | 0.0040 | 0.0098 | 0.10 | 0.25 |
| J | 0.0034 | 0.0070 | 0.085 | 0.177 |
| K | 0.0180 | 0.0236 | 0.45 | 0.60 |
| L | 0.0350 | 0.0401 | 0.89 | 1.02 |
| S | 0.0830 | 0.0984 | 2.10 | 2.50 |
| V | 0.0177 | 0.0236 | 0.45 | 0.60 |

- STYLE 12:
PIN 1. CATHODE
2. CATHODE
3. ANODE

SOLDERING FOOTPRINT*

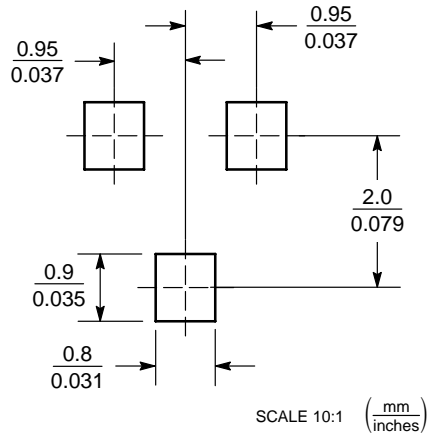

*For additional information on our Pb-Free strategy and soldering details, please download the ON Semiconductor Soldering and Mounting Techniques Reference Manual, SOLDERRM/D.

MMBZ5V6ALT1 Series

ON Semiconductor and  are registered trademarks of Semiconductor Components Industries, LLC (SCILLC). SCILLC reserves the right to make changes without further notice to any products herein. SCILLC makes no warranty, representation or guarantee regarding the suitability of its products for any particular purpose, nor does SCILLC assume any liability arising out of the application or use of any product or circuit, and specifically disclaims any and all liability, including without limitation special, consequential or incidental damages. "Typical" parameters which may be provided in SCILLC data sheets and/or specifications can and do vary in different applications and actual performance may vary over time. All operating parameters, including "Typicals" must be validated for each customer application by customer's technical experts. SCILLC does not convey any license under its patent rights nor the rights of others. SCILLC products are not designed, intended, or authorized for use as components in systems intended for surgical implant into the body, or other applications intended to support or sustain life, or for any other application in which the failure of the SCILLC product could create a situation where personal injury or death may occur. Should Buyer purchase or use SCILLC products for any such unintended or unauthorized application, Buyer shall indemnify and hold SCILLC and its officers, employees, subsidiaries, affiliates, and distributors harmless against all claims, costs, damages, and expenses, and reasonable attorney fees arising out of, directly or indirectly, any claim of personal injury or death associated with such unintended or unauthorized use, even if such claim alleges that SCILLC was negligent regarding the design or manufacture of the part. SCILLC is an Equal Opportunity/Affirmative Action Employer. This literature is subject to all applicable copyright laws and is not for resale in any manner.

PUBLICATION ORDERING INFORMATION

LITERATURE FULFILLMENT:

Literature Distribution Center for ON Semiconductor
P.O. Box 61312, Phoenix, Arizona 85082-1312 USA

Phone: 480-829-7710 or 800-344-3860 Toll Free USA/Canada

Fax: 480-829-7709 or 800-344-3867 Toll Free USA/Canada

Email: orderlit@onsemi.com

N. American Technical Support: 800-282-9855 Toll Free
USA/Canada

Japan: ON Semiconductor, Japan Customer Focus Center
2-9-1 Kamimeguro, Meguro-ku, Tokyo, Japan 153-0051
Phone: 81-3-5773-3850

ON Semiconductor Website: <http://onsemi.com>

Order Literature: <http://www.onsemi.com/litorder>

For additional information, please contact your
local Sales Representative.

MMBZ5V6ALT1/D