

LM140A/LM140/LM340A/LM340/LM7800C Series 3-Terminal Positive Regulators

General Description

The LM140A/LM140/LM340A/LM340/LM7800C monolithic 3-terminal positive voltage regulators employ internal current-limiting, thermal shutdown and safe-area compensation, making them essentially indestructible. If adequate heat sinking is provided, they can deliver over 1.0A output current. They are intended as fixed voltage regulators in a wide range of applications including local (on-card) regulation for elimination of noise and distribution problems associated with single-point regulation. In addition to use as fixed voltage regulators, these devices can be used with external components to obtain adjustable output voltages and currents.

Considerable effort was expended to make the entire series of regulators easy to use and minimize the number of external components. It is not necessary to bypass the output, although this does improve transient response. Input bypassing is needed only if the regulator is located far from the filter capacitor of the power supply.

The 5V, 12V, and 15V regulator options are available in the steel TO-3 power package. The LM340A/LM340/LM7800C series is available in the TO-220 plastic power package, and the LM7805 and LM7812 are also available in the surface-mount TO-263 package.

Features

- Complete specifications at 1A load
- Output voltage tolerances of $\pm 2\%$ at $T_j = 25^\circ\text{C}$ and $\pm 4\%$ over the temperature range (LM140A/LM340A)
- Line regulation of 0.01% of V_{OUT}/V of ΔV_{IN} at 1A load (LM140A/LM340A)
- Load regulation of 0.3% of V_{OUT}/A (LM140A/LM340A)
- Internal thermal overload protection
- Internal short-circuit current limit
- Output transistor safe area protection
- P⁺ Product Enhancement tested

Device	Output Voltages	Packages
LM140A/LM140	5, 12, 15	TO-3 (K)
LM340A/LM340	5, 12, 15	TO-3 (K), TO-220 (T)
LM7800C	5, 6, 8, 12, 15, 18, 24	TO-220 (T), TO-263 (S) (5V and 12V only)

Typical Applications

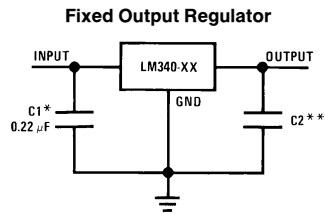

*Required if the regulator is located far from the power supply filter.

**Although no output capacitor is needed for stability, it does help transient response. (If needed, use 0.1 μF , ceramic disc).

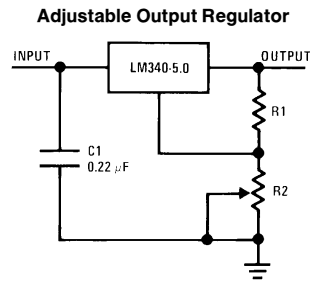

$V_{OUT} = 5V + (5V/R1 + I_Q) R2$ $5V/R1 > 3 I_Q$,
load regulation (L_r) $\approx [(R1 + R2)/R1]$ (L_r of LM340-5).

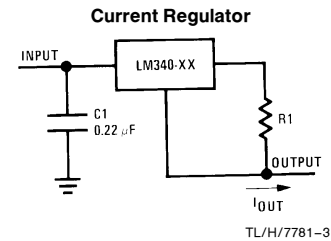

$$I_{OUT} = \frac{V_{2-3}}{R1} + I_Q$$

$$\Delta I_Q = 1.3 \text{ mA over line and load changes.}$$

Absolute Maximum Ratings (Note 1)

If Military/Aerospace specified devices are required, please contact the National Semiconductor Sales Office/Distributors for availability and specifications. (Note 5)

DC Input Voltage	All Devices except LM7824/LM7824C	35V
	LM7824/LM7824C	40V
Internal Power Dissipation (Note 2)	Internally Limited	
Maximum Junction Temperature	150°C	
Storage Temperature Range	-65°C to +150°C	
Lead Temperature (Soldering, 10 sec.)	TO-3 Package (K) 300°C	
	TO-220 Package (T), TO-263 Package (S) 230°C	
ESD Susceptibility (Note 3)	2 kV	

Operating Conditions (Note 1)

Temperature Range (T _A) (Note 2)	LM140A, LM140	-55°C to +125°C
	LM340A, LM340, LM7805C, LM7812C, LM7815C	0°C to +70°C
	LM7806C, LM7808C, LM7818C, LM7824C	0°C to +125°C

LM140A/LM340A

Electrical Characteristics

I_{OUT} = 1A, -55°C ≤ T_J ≤ +150°C (LM140A), or 0°C ≤ T_J ≤ +125°C (LM340A) unless otherwise specified (Note 4)

Symbol	Output Voltage		5V			12V			15V			Units
	Input Voltage (unless otherwise noted)		10V			19V			23V			
	Parameter	Conditions	Min	Typ	Max	Min	Typ	Max	Min	Typ	Max	
V _O	Output Voltage	T _J = 25°C	4.9	5	5.1	11.75	12	12.25	14.7	15	15.3	V
		P _D ≤ 15W, 5 mA ≤ I _O ≤ 1A	4.8		5.2	11.5		12.5	14.4		15.6	V
		V _{MIN} ≤ V _{IN} ≤ V _{MAX}	(7.5 ≤ V _{IN} ≤ 20)			(14.8 ≤ V _{IN} ≤ 27)			(17.9 ≤ V _{IN} ≤ 30)			V
ΔV _O	Line Regulation	I _O = 500 mA	10			18			22			mV
		ΔV _{IN}	(7.5 ≤ V _{IN} ≤ 20)			(14.8 ≤ V _{IN} ≤ 27)			(17.9 ≤ V _{IN} ≤ 30)			V
		T _J = 25°C	3 10			4 18			4 22			mV
		ΔV _{IN}	(7.5 ≤ V _{IN} ≤ 20)			(14.5 ≤ V _{IN} ≤ 27)			(17.5 ≤ V _{IN} ≤ 30)			V
ΔV _O	Load Regulation	T _J = 25°C	5 mA ≤ I _O ≤ 1.5A		10	25	12	32	12	35	mV	
			250 mA ≤ I _O ≤ 750 mA			15		19		21	mV	
		Over Temperature, 5 mA ≤ I _O ≤ 1A			25		60		75		mV	
I _Q	Quiescent Current	T _J = 25°C	6			6			6			mA
		Over Temperature	6.5			6.5			6.5			mA
ΔI _Q	Quiescent Current Change	5 mA ≤ I _O ≤ 1A	0.5			0.5			0.5			mA
		T _J = 25°C, I _O = 1A	0.8			0.8			0.8			mA
		V _{MIN} ≤ V _{IN} ≤ V _{MAX}	(7.5 ≤ V _{IN} ≤ 20)			(14.8 ≤ V _{IN} ≤ 27)			(17.9 ≤ V _{IN} ≤ 30)			V
V _N	Output Noise Voltage	I _O = 500 mA	0.8			0.8			0.8			mA
		V _{MIN} ≤ V _{IN} ≤ V _{MAX}	(8 ≤ V _{IN} ≤ 25)			(15 ≤ V _{IN} ≤ 30)			(17.9 ≤ V _{IN} ≤ 30)			V
ΔV _{IN} ΔV _{OUT}	Ripple Rejection	T _A = 25°C, 10 Hz ≤ f ≤ 100 kHz	40			75			90			μV
		T _J = 25°C, f = 120 Hz, I _O = 1A or f = 120 Hz, I _O = 500 mA, Over Temperature, V _{MIN} ≤ V _{IN} ≤ V _{MAX}	68	80	68	61	72	61	60	70	60	dB
R _O	Dropout Voltage Output Resistance Short-Circuit Current Peak Output Current Average TC of V _O	T _J = 25°C, I _O = 1A	2.0			2.0			2.0			V
		f = 1 kHz	8			18			19			mΩ
		T _J = 25°C	2.1			1.5			1.2			A
		T _J = 25°C	2.4			2.4			2.4			A
		Min, T _J = 0°C, I _O = 5 mA	-0.6			-1.5			-1.8			mV/°C
V _{IN}	Input Voltage Required to Maintain Line Regulation	T _J = 25°C	7.5			14.5			17.5			V

LM140

Electrical Characteristics (Note 4) $-55^{\circ}\text{C} \leq T_J \leq +150^{\circ}\text{C}$ unless otherwise specified

Symbol	Output Voltage		5V			12V			15V			Units	
	Input Voltage (unless otherwise noted)		10V			19V			23V				
	Parameter	Conditions	Min	Typ	Max	Min	Typ	Max	Min	Typ	Max		
V_O	Output Voltage	$T_J = 25^{\circ}\text{C}, 5\text{ mA} \leq I_O \leq 1\text{ A}$	4.8	5	5.2	11.5	12	12.5	14.4	15	15.6	V	
		$P_D \leq 15\text{ W}, 5\text{ mA} \leq I_O \leq 1\text{ A}$ $V_{\text{MIN}} \leq V_{\text{IN}} \leq V_{\text{MAX}}$	4.75		5.25	11.4		12.6	14.25		15.75	V V	
ΔV_O	Line Regulation	$I_O = 500\text{ mA}$	$T_J = 25^{\circ}\text{C}$		3	50		4	120		4	150	mV V
			ΔV_{IN}		($7 \leq V_{\text{IN}} \leq 25$)		($14.5 \leq V_{\text{IN}} \leq 30$)		($17.5 \leq V_{\text{IN}} \leq 30$)				
		$-55^{\circ}\text{C} \leq T_J \leq +150^{\circ}\text{C}$			50			120			150	mV V	
		ΔV_{IN}		($8 \leq V_{\text{IN}} \leq 20$)		($15 \leq V_{\text{IN}} \leq 27$)		($18.5 \leq V_{\text{IN}} \leq 30$)					
ΔV_O	Load Regulation	$T_J = 25^{\circ}\text{C}$	$5\text{ mA} \leq I_O \leq 1.5\text{ A}$ $250\text{ mA} \leq I_P \leq 750\text{ mA}$		10	50		12	120		12	150	mV mV
						25		60		75			
			$-55^{\circ}\text{C} \leq T_J \leq +150^{\circ}\text{C}$ $5\text{ mA} \leq I_O \leq 1\text{ A}$			50			120			150	mV
I_Q	Quiescent Current	$I_O \leq 1\text{ A}$	$T_J = 25^{\circ}\text{C}$		6			6			6	mA mA	
			$-55^{\circ}\text{C} \leq T_J \leq +150^{\circ}\text{C}$			7			7			7	
ΔI_Q	Quiescent Current Change	$5\text{ mA} \leq I_O \leq 1\text{ A}$			0.5			0.5			0.5	mA	
		$T_J = 25^{\circ}\text{C}, I_O \leq 1\text{ A}$ $V_{\text{MIN}} \leq V_{\text{IN}} \leq V_{\text{MAX}}$			0.8		0.8		0.8		0.8	mA V	
			$I_O = 500\text{ mA}, -55^{\circ}\text{C} \leq T_J \leq +150^{\circ}\text{C}$ $V_{\text{MIN}} \leq V_{\text{IN}} \leq V_{\text{MAX}}$			0.8		0.8		0.8		0.8	
V_N	Output Noise Voltage	$T_A = 25^{\circ}\text{C}, 10\text{ Hz} \leq f \leq 100\text{ kHz}$			40			75			90	μV	
$\frac{\Delta V_{\text{IN}}}{\Delta V_{\text{OUT}}}$	Ripple Rejection	$f = 120\text{ Hz}$	$\begin{cases} I_O \leq 1\text{ A}, T_J = 25^{\circ}\text{C} \text{ or} \\ I_O \leq 500\text{ mA}, \\ -55^{\circ}\text{C} \leq T_J \leq +150^{\circ}\text{C} \end{cases}$		68	80		61	72		60	70	dB dB
				$V_{\text{MIN}} \leq V_{\text{IN}} \leq V_{\text{MAX}}$		68		61		60		60	
R_O	Dropout Voltage Output Resistance Short-Circuit Current Peak Output Current Average TC of V_{OUT}	$T_J = 25^{\circ}\text{C}, I_O = 1\text{ A}$			2.0			2.0			2.0	V m Ω A A mV/ $^{\circ}\text{C}$	
		$f = 1\text{ kHz}$			8			18			19		
		$T_J = 25^{\circ}\text{C}$			2.1			1.5			1.2		
		$T_J = 25^{\circ}\text{C}$			2.4			2.4			2.4		
		$0^{\circ}\text{C} \leq T_J \leq +150^{\circ}\text{C}, I_O = 5\text{ mA}$			-0.6			-1.5			-1.8		
V_{IN}	Input Voltage Required to Maintain Line Regulation	$T_J = 25^{\circ}\text{C}, I_O \leq 1\text{ A}$			7.5			14.6			17.7	V	

LM340/LM7800C

Electrical Characteristics (Note 4) $0^{\circ}\text{C} \leq T_J \leq +125^{\circ}\text{C}$ unless otherwise specified

Symbol	Output Voltage		5V			12V			15V			Units
	Input Voltage (unless otherwise noted)		10V			19V			23V			
	Parameter	Conditions	Min	Typ	Max	Min	Typ	Max	Min	Typ	Max	
V_O	Output Voltage	$T_J = 25^{\circ}\text{C}, 5\text{ mA} \leq I_O \leq 1\text{ A}$	4.8	5	5.2	11.5	12	12.5	14.4	15	15.6	V
		$P_D \leq 15\text{ W}, 5\text{ mA} \leq I_O \leq 1\text{ A}$	4.75		5.25	11.4		12.6	14.25		15.75	V
		$V_{\text{MIN}} \leq V_{\text{IN}} \leq V_{\text{MAX}}$	(7.5 $\leq V_{\text{IN}} \leq 20$)				(14.5 $\leq V_{\text{IN}} \leq 27$)			(17.5 $\leq V_{\text{IN}} \leq 30$)		V
ΔV_O	Line Regulation	$I_O = 500\text{ mA}$	$T_J = 25^{\circ}\text{C}$	3	50	4	120	4	150			mV
			ΔV_{IN}	(7 $\leq V_{\text{IN}} \leq 25$)			(14.5 $\leq V_{\text{IN}} \leq 30$)			(17.5 $\leq V_{\text{IN}} \leq 30$)		V
			$0^{\circ}\text{C} \leq T_J \leq +125^{\circ}\text{C}$		50		120		150			mV
		$I_O \leq 1\text{ A}$	ΔV_{IN}	(8 $\leq V_{\text{IN}} \leq 20$)			(15 $\leq V_{\text{IN}} \leq 27$)			(18.5 $\leq V_{\text{IN}} \leq 30$)		V
			$T_J = 25^{\circ}\text{C}$		50		120		150			mV
			$0^{\circ}\text{C} \leq T_J \leq +125^{\circ}\text{C}$		(7.5 $\leq V_{\text{IN}} \leq 20$)		(14.6 $\leq V_{\text{IN}} \leq 27$)		(17.7 $\leq V_{\text{IN}} \leq 30$)			V
ΔV_O	Load Regulation	$T_J = 25^{\circ}\text{C}$	$5\text{ mA} \leq I_O \leq 1.5\text{ A}$	10	50	12	120	12	150			mV
			$250\text{ mA} \leq I_O \leq 750\text{ mA}$		25		60		75			mV
		$5\text{ mA} \leq I_O \leq 1\text{ A}, 0^{\circ}\text{C} \leq T_J \leq +125^{\circ}\text{C}$		50		120		150			mV	
I_Q	Quiescent Current	$I_O \leq 1\text{ A}$	$T_J = 25^{\circ}\text{C}$	8		8		8			mA	
			$0^{\circ}\text{C} \leq T_J \leq +125^{\circ}\text{C}$		8.5		8.5		8.5			mA
ΔI_Q	Quiescent Current Change	$5\text{ mA} \leq I_O \leq 1\text{ A}$	$T_J = 25^{\circ}\text{C}, I_O \leq 1\text{ A}$		0.5		0.5		0.5			mA
			$V_{\text{MIN}} \leq V_{\text{IN}} \leq V_{\text{MAX}}$	(7.5 $\leq V_{\text{IN}} \leq 20$)		1.0		1.0		1.0		mA
		$I_O \leq 500\text{ mA}, 0^{\circ}\text{C} \leq T_J \leq +125^{\circ}\text{C}$	$V_{\text{MIN}} \leq V_{\text{IN}} \leq V_{\text{MAX}}$	(7 $\leq V_{\text{IN}} \leq 25$)		1.0		1.0		1.0		mA
												V
V_N	Output Noise Voltage	$T_A = 25^{\circ}\text{C}, 10\text{ Hz} \leq f \leq 100\text{ kHz}$	40		75		90				μV	
$\frac{\Delta V_{\text{IN}}}{\Delta V_{\text{OUT}}}$	Ripple Rejection	$f = 120\text{ Hz}$	$I_O \leq 1\text{ A}, T_J = 25^{\circ}\text{C}$	62	80	55	72	54	70			dB
			or $I_O \leq 500\text{ mA},$	62		55		54				dB
			$0^{\circ}\text{C} \leq T_J \leq +125^{\circ}\text{C}$	(8 $\leq V_{\text{IN}} \leq 18$)			(15 $\leq V_{\text{IN}} \leq 25$)			(18.5 $\leq V_{\text{IN}} \leq 28.5$)		V
R_O	Dropout Voltage	$T_J = 25^{\circ}\text{C}, I_O = 1\text{ A}$	2.0		2.0		2.0				V	
	Output Resistance	$f = 1\text{ kHz}$	8		18		19				$\text{m}\Omega$	
	Short-Circuit Current	$T_J = 25^{\circ}\text{C}$	2.1		1.5		1.2				A	
	Peak Output Current	$T_J = 25^{\circ}\text{C}$	2.4		2.4		2.4				A	
	Average TC of V_{OUT}	$0^{\circ}\text{C} \leq T_J \leq +125^{\circ}\text{C}, I_O = 5\text{ mA}$	-0.6		-1.5		-1.8				$\text{mV}/^{\circ}\text{C}$	
V_{IN}	Input Voltage Required to Maintain Line Regulation	$T_J = 25^{\circ}\text{C}, I_O \leq 1\text{ A}$	7.5		14.6		17.7				V	

Note 1: Absolute Maximum Ratings are limits beyond which damage to the device may occur. Operating Conditions are conditions under which the device functions but the specifications might not be guaranteed. For guaranteed specifications and test conditions see the Electrical Characteristics.

Note 2: The maximum allowable power dissipation at any ambient temperature is a function of the maximum junction temperature for operation ($T_{\text{JMAX}} = 125^{\circ}\text{C}$ or 150°C), the junction-to-ambient thermal resistance (θ_{JA}), and the ambient temperature (T_A). $P_{\text{DMAX}} = (T_{\text{JMAX}} - T_A)/\theta_{\text{JA}}$. If this dissipation is exceeded, the die temperature will rise above T_{JMAX} and the electrical specifications do not apply. If the die temperature rises above 150°C , the device will go into thermal shutdown. For the TO-3 package (K, KC), the junction-to-ambient thermal resistance (θ_{JA}) is $39^{\circ}\text{C}/\text{W}$. When using a heatsink, θ_{JA} is the sum of the $4^{\circ}\text{C}/\text{W}$ junction-to-case thermal resistance (θ_{JC}) of the TO-3 package and the case-to-ambient thermal resistance of the heatsink. For the TO-220 package (T), θ_{JA} is $54^{\circ}\text{C}/\text{W}$ and θ_{JC} is $4^{\circ}\text{C}/\text{W}$.

If the TO-263 package is used, the thermal resistance can be reduced by increasing the PC board copper area thermally connected to the package: Using 0.5 square inches of copper area, θ_{JA} is $50^{\circ}\text{C}/\text{W}$; with 1 square inch of copper area, θ_{JA} is $37^{\circ}\text{C}/\text{W}$; and with 1.6 or more inches of copper area, θ_{JA} is $32^{\circ}\text{C}/\text{W}$.

Note 3: ESD rating is based on the human body model, 100 pF discharged through 1.5 k Ω .

Note 4: All characteristics are measured with a 0.22 μF capacitor from input to ground and a 0.1 μF capacitor from output to ground. All characteristics except noise voltage and ripple rejection ratio are measured using pulse techniques ($t_w \leq 10\text{ ms}$, duty cycle $\leq 5\%$). Output voltage changes due to changes in internal temperature must be taken into account separately.

Note 5: A military RETS specification is available on request. At the time of printing, the military RETS specifications for the LM140AK-5.0/883, LM140AK-12/883, and LM140AK-15/883 complied with the min and max limits for the respective versions of the LM140A. At the time of printing, the military RETS specifications for the LM140K-5.0/883, LM140K-12/883, and LM140K-15/883 complied with the min and max limits for the respective versions of the LM140. The LM140H/883, LM140K/883, and LM140AK/883 may also be procured as a Standard Military Drawing.

LM7806C Electrical Characteristics

$0^{\circ}\text{C} \leq T_J \leq +150^{\circ}\text{C}$, $V_I = 11\text{V}$, $I_O = 500\text{ mA}$, $C_I = 0.33\ \mu\text{F}$, $C_O = 0.1\ \mu\text{F}$, unless otherwise specified

Symbol	Parameter	Conditions (Note 4)	LM7806C			Units	
			Min	Typ	Max		
V_O	Output Voltage	$T_J = 25^{\circ}\text{C}$	5.75	6.0	6.25	V	
ΔV_O	Line Regulation	$T_J = 25^{\circ}\text{C}$		$8.0\text{V} \leq V_I \leq 25\text{V}$	5.0	120	mV
				$9.0\text{V} \leq V_I \leq 13\text{V}$	1.5	60	
ΔV_O	Load Regulation	$T_J = 25^{\circ}\text{C}$		$5.0\text{ mA} \leq I_O \leq 1.5\text{A}$	14	120	mV
				$250\text{ mA} \leq I_O \leq 750\text{ mA}$	4.0	60	
V_O	Output Voltage	$8.0\text{V} \leq V_I \leq 21\text{V}$, $5.0\text{ mA} \leq I_O \leq 1.0\text{A}$, $P \leq 15\text{W}$	5.7		6.3	V	
I_Q	Quiescent Current	$T_J = 25^{\circ}\text{C}$		4.3	8.0	mA	
ΔI_Q	Quiescent Current Change			With Line		1.3	mA
				With Load	$5.0\text{ mA} \leq I_O \leq 1.0\text{A}$		
V_N	Noise	$T_A = 25^{\circ}\text{C}$, $10\text{ Hz} \leq f \leq 100\text{ kHz}$		45		μV	
$\Delta V_I/\Delta V_O$	Ripple Rejection	$f = 120\text{ Hz}$, $I_O = 350\text{ mA}$, $T_J = 25^{\circ}\text{C}$	59	75		dB	
V_{DO}	Dropout Voltage	$I_O = 1.0\text{A}$, $T_J = 25^{\circ}\text{C}$		2.0		V	
R_O	Output Resistance	$f = 1.0\text{ kHz}$		9		$\text{m}\Omega$	
I_{OS}	Output Short Circuit Current	$T_J = 25^{\circ}\text{C}$, $V_I = 35\text{V}$		550		mA	
I_{PK}	Peak Output Current	$T_J = 25^{\circ}\text{C}$		2.2		A	
$\Delta V_O/\Delta T$	Average Temperature Coefficient of Output Voltage	$I_O = 5.0\text{ mA}$, $0^{\circ}\text{C} \leq T_A \leq +125^{\circ}\text{C}$		0.8		$\text{mV}/^{\circ}\text{C}$	

LM7808C Electrical Characteristics

$0^{\circ}\text{C} \leq T_J \leq +150^{\circ}\text{C}$, $V_I = 14\text{V}$, $I_O = 500\text{ mA}$, $C_I = 0.33\ \mu\text{F}$, $C_O = 0.1\ \mu\text{F}$, unless otherwise specified

Symbol	Parameter	Conditions (Note 4)	LM7808C			Units	
			Min	Typ	Max		
V_O	Output Voltage	$T_J = 25^{\circ}\text{C}$	7.7	8.0	8.3	V	
ΔV_O	Line Regulation	$T_J = 25^{\circ}\text{C}$		$10.5\text{V} \leq V_I \leq 25\text{V}$	6.0	160	mV
				$11.0\text{V} \leq V_I \leq 17\text{V}$	2.0	80	
ΔV_O	Load Regulation	$T_J = 25^{\circ}\text{C}$		$5.0\text{ mA} \leq I_O \leq 1.5\text{A}$	12	160	mV
				$250\text{ mA} \leq I_O \leq 750\text{ mA}$	4.0	80	
V_O	Output Voltage	$11.5\text{V} \leq V_I \leq 23\text{V}$, $5.0\text{ mA} \leq I_O \leq 1.0\text{A}$, $P \leq 15\text{W}$	7.6		8.4	V	
I_Q	Quiescent Current	$T_J = 25^{\circ}\text{C}$		4.3	8.0	mA	
ΔI_Q	Quiescent Current Change			With Line		1.0	mA
				With Load	$5.0\text{ mA} \leq I_O \leq 1.0\text{A}$		
V_N	Noise	$T_A = 25^{\circ}\text{C}$, $10\text{ Hz} \leq f \leq 100\text{ kHz}$		52		μV	
$\Delta V_I/\Delta V_O$	Ripple Rejection	$f = 120\text{ Hz}$, $I_O = 350\text{ mA}$, $T_J = 25^{\circ}\text{C}$	56	72		dB	
V_{DO}	Dropout Voltage	$I_O = 1.0\text{A}$, $T_J = 25^{\circ}\text{C}$		2.0		V	
R_O	Output Resistance	$f = 1.0\text{ kHz}$		16		$\text{m}\Omega$	
I_{OS}	Output Short Circuit Current	$T_J = 25^{\circ}\text{C}$, $V_I = 35\text{V}$		0.45		A	
I_{PK}	Peak Output Current	$T_J = 25^{\circ}\text{C}$		2.2		A	
$\Delta V_O/\Delta T$	Average Temperature Coefficient of Output Voltage	$I_O = 5.0\text{ mA}$		0.8		$\text{mV}/^{\circ}\text{C}$	

Note 4: All characteristics are measured with a $0.22\ \mu\text{F}$ capacitor from input to ground and a $0.1\ \mu\text{F}$ capacitor from output to ground. All characteristics except noise voltage and ripple rejection ratio are measured using pulse techniques ($t_w \leq 10\text{ ms}$, duty cycle $\leq 5\%$). Output voltage changes due to changes in internal temperature must be taken into account separately.

LM7818C

Electrical Characteristics

0°C ≤ T_J ≤ +150°C, V_I = 27V, I_O = 500 mA, C_I = 0.33 μF, C_O = 0.1 μF, unless otherwise specified

Symbol	Parameter	Conditions (Note 4)		LM7818C			Units
				Min	Typ	Max	
V _O	Output Voltage	T _J = 25°C		17.3	18.0	18.7	V
ΔV _O	Line Regulation	T _J = 25°C	21V ≤ V _I ≤ 33V		15	360	mV
			24V ≤ V _I ≤ 30V		5.0	180	
ΔV _O	Load Regulation	T _J = 25°C	5.0 mA ≤ I _O ≤ 1.5A		12	360	mV
			250 mA ≤ I _O ≤ 750 mA		4.0	180	
V _O	Output Voltage	22V ≤ V _I ≤ 33V, 5.0 mA ≤ I _O ≤ 1.0A, P ≤ 15W		17.1		18.9	V
I _Q	Quiescent Current	T _J = 25°C			4.5	8.0	mA
ΔI _Q	Quiescent Current Change	With Line	22V ≤ V _I ≤ 33V			1.0	mA
		With Load	5.0 mA ≤ I _O ≤ 1.0A			0.5	
V _N	Noise	T _A = 25°C, 10 Hz ≤ f ≤ 100 kHz			110		μV
ΔV _I /ΔV _O	Ripple Rejection	f = 120 Hz, I _O = 350 mA, T _J = 25°C		53	69		dB
V _{DO}	Dropout Voltage	I _O = 1.0A, T _J = 25°C			2.0		V
R _O	Output Resistance	f = 1.0 kHz			22		mΩ
I _{OS}	Output Short Circuit Current	T _J = 25°C, V _I = 35V			0.20		A
I _{PK}	Peak Output Current	T _J = 25°C			2.1		A
ΔV _O /ΔT	Average Temperature Coefficient of Output Voltage	I _O = 5.0 mA			1.0		mV/°C

LM7824C

Electrical Characteristics

0°C ≤ T_J ≤ +150°C, V_I = 33V, I_O = 500 mA, C_I = 0.33 μF, C_O = 0.1 μF, unless otherwise specified

Symbol	Parameter	Conditions (Note 4)		LM7824C			Units
				Min	Typ	Max	
V _O	Output Voltage	T _J = 25°C		23.0	24.0	25.0	V
ΔV _O	Line Regulation	T _J = 25°C	27V ≤ V _I ≤ 38V		18	480	mV
			30V ≤ V _I ≤ 36V		6.0	240	
ΔV _O	Load Regulation	T _J = 25°C	5.0 mA ≤ I _O ≤ 1.5A		12	480	mV
			250 mA ≤ I _O ≤ 750 mA		4.0	240	
V _O	Output Voltage	28V ≤ V _I ≤ 38V, 5.0 mA ≤ I _O ≤ 1.0A, P ≤ 15W		22.8		25.2	V
I _Q	Quiescent Current	T _J = 25°C			4.6	8.0	mA
ΔI _Q	Quiescent Current Change	With Line	28V ≤ V _I ≤ 38V			1.0	mA
		With Load	5.0 mA ≤ I _O ≤ 1.0A			0.5	
V _N	Noise	T _A = 25°C, 10 Hz ≤ f ≤ 100 kHz			170		μV
ΔV _I /ΔV _O	Ripple Rejection	f = 120 Hz, I _O = 350 mA, T _J = 25°C		50	66		dB
V _{DO}	Dropout Voltage	I _O = 1.0A, T _J = 25°C			2.0		V
R _O	Output Resistance	f = 1.0 kHz			28		mΩ
I _{OS}	Output Short Circuit Current	T _J = 25°C, V _I = 35V			0.15		A
I _{PK}	Peak Output Current	T _J = 25°C			2.1		A
ΔV _O /ΔT	Average Temperature Coefficient of Output Voltage	I _O = 5.0 mA			1.5		mV/°C

Note 4: All characteristics are measured with a 0.22 μF capacitor from input to ground and a 0.1 μF capacitor from output to ground. All characteristics except noise voltage and ripple rejection ratio are measured using pulse techniques (t_w ≤ 10 ms, duty cycle ≤ 5%). Output voltage changes due to changes in internal temperature must be taken into account separately.

Typical Performance Characteristics

Maximum Average Power Dissipation

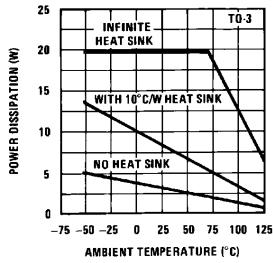

Maximum Average Power Dissipation

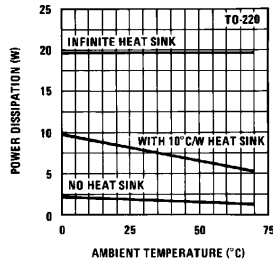

Maximum Power Dissipation (TO-263)
(See Note 2)

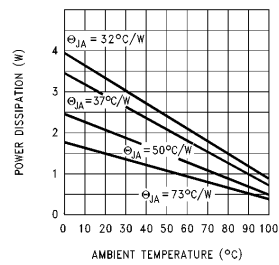

Output Voltage (Normalized to 1V at Tj = 25°C)

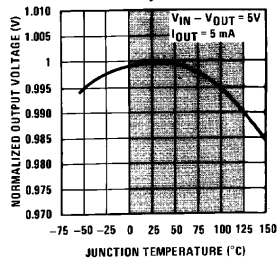

Ripple Rejection

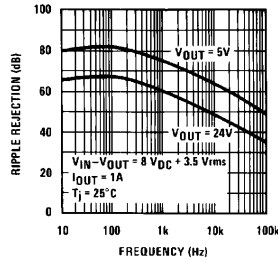

Ripple Rejection

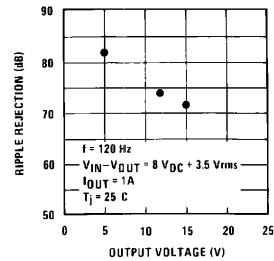

Note: Shaded area refers to LM340A/LM340, LM7805C, LM7812C and LM7815C.

Output Impedance

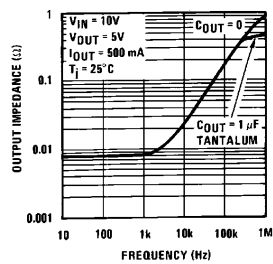

Dropout Characteristics

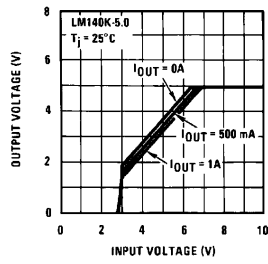

Quiescent Current

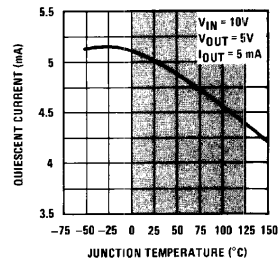

Note: Shaded area refers to LM340A/LM340, LM7805C, LM7812C and LM7815C.

Peak Output Current

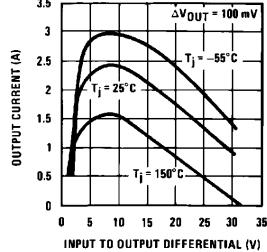

Dropout Voltage

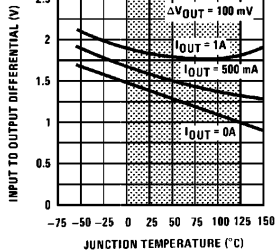

Quiescent Current

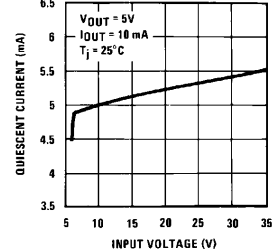

Note: Shaded area refers to LM340A/LM340, LM7805C, LM7812C and LM7815C.

TL/H/7781-4

Typical Performance Characteristics (Continued)

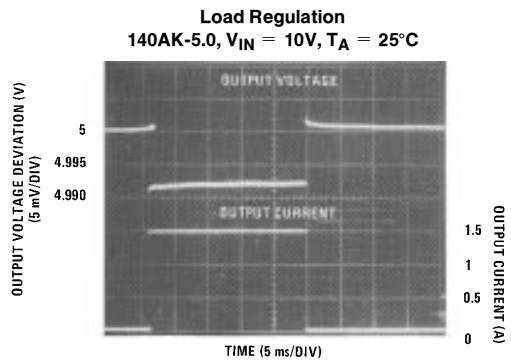

TL/H/7781-5

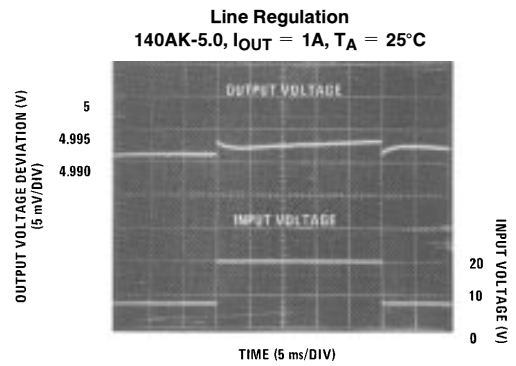

TL/H/7781-6

Equivalent Schematic

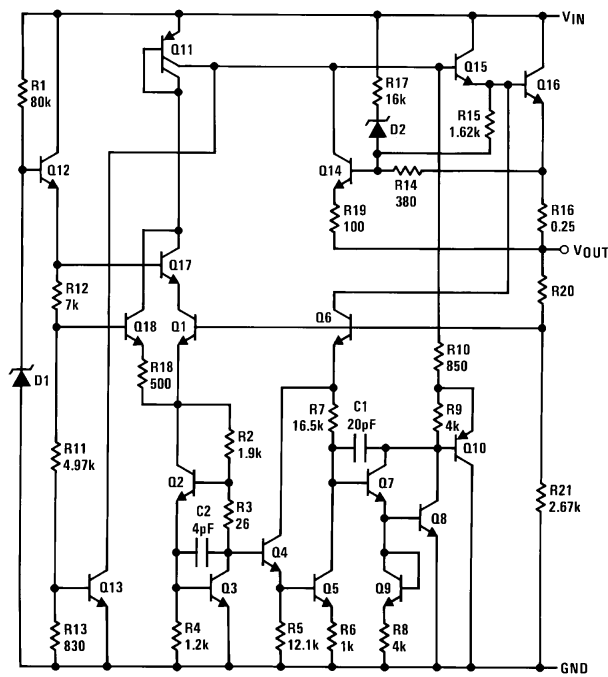

Application Hints

The LM340/LM78XX series is designed with thermal protection, output short-circuit protection and output transistor safe area protection. However, as with *any* IC regulator, it becomes necessary to take precautions to assure that the regulator is not inadvertently damaged. The following describes possible misapplications and methods to prevent damage to the regulator.

Shorting the Regulator Input: When using large capacitors at the output of these regulators, a protection diode connected input to output (*Figure 1*) may be required if the input is shorted to ground. Without the protection diode, an input short will cause the input to rapidly approach ground potential, while the output remains near the initial V_{OUT} because of the stored charge in the large output capacitor. The capacitor will then discharge through a large internal input to output diode and parasitic transistors. If the energy released by the capacitor is large enough, this diode, low current metal and the regulator will be destroyed. The fast diode in *Figure 1* will shunt most of the capacitors discharge current around the regulator. Generally no protection diode is required for values of output capacitance $\leq 10 \mu\text{F}$.

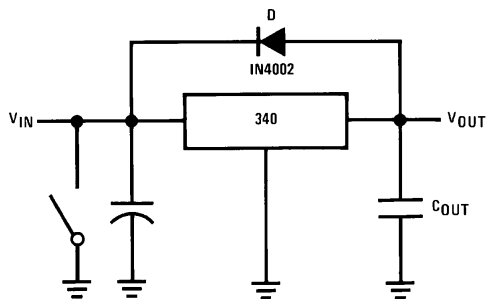

FIGURE 1. Input Short

TL/H/7781-8

Raising the Output Voltage above the Input Voltage: Since the output of the device does not sink current, forcing the output high can cause damage to internal low current paths in a manner similar to that just described in the "Shorting the Regulator Input" section.

Regulator Floating Ground (*Figure 2*): When the ground pin alone becomes disconnected, the output approaches the unregulated input, causing possible damage to other circuits connected to V_{OUT} . If ground is reconnected with power "ON", damage may also occur to the regulator. This fault is most likely to occur when plugging in regulators or modules with on card regulators into powered up sockets. Power should be turned off first, thermal limit ceases operating, or ground should be connected first if power must be left on.

Transient Voltages: If transients exceed the maximum rated input voltage of the device, or reach more than 0.8V below ground and have sufficient energy, they will damage the regulator. The solution is to use a large input capacitor, a series input breakdown diode, a choke, a transient suppressor or a combination of these.

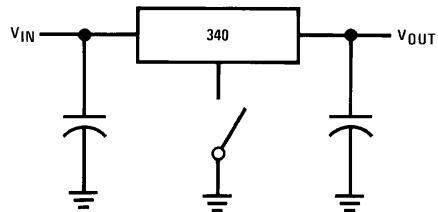

TL/H/7781-9

FIGURE 2. Regulator Floating Ground

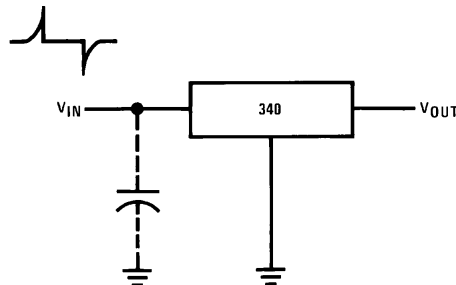
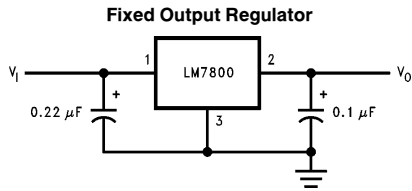

FIGURE 3. Transients

TL/H/7781-10

Typical Applications



TL/H/7781-13

Note 1: Bypass capacitors are recommended for optimum stability and transient response, and should be located as close as possible to the regulator.

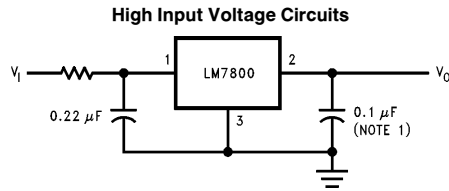

TL/H/7781-14

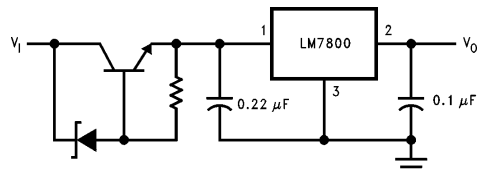

TL/H/7781-15

High Current Voltage Regulator

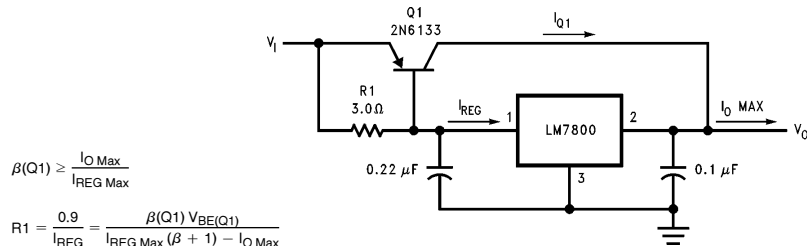

TL/H/7781-16

High Output Current, Short Circuit Protected

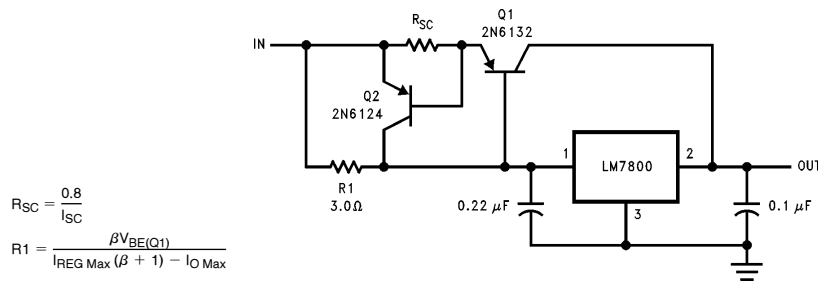

TL/H/7781-17

Positive and Negative Regulator

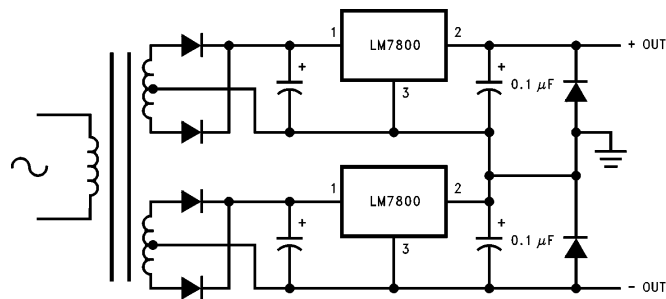

TL/H/7781-18

Connection Diagrams and Ordering Information

TO-3 Metal Can Package (K)

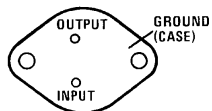

TL/H/7781-11

Bottom View

Steel Package Order Numbers:

LM140K-5.0	LM140K-12	LM140K-15
LM340AK-5.0	LM340K-12	LM340K-15
LM340K-5.0		

See Package Number K02A

LM140AK-5.0/883	LM140AK-12/883	LM140AK-15/883
LM140K-5.0/883	LM140K-12/883	LM140K-15/883

See Package Number K02C

TO-220 Power Package (T)

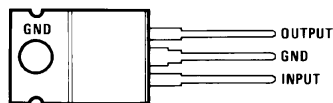

TL/H/7781-12

Top View

Plastic Package Order Numbers:

LM340AT-5.0	LM340T-5.0
LM340AT-12	LM340T-12
LM340AT-15	LM340T-15
LM7805CT	LM7812CT
LM7815CT	LM7806CT
LM7808CT	LM7818CT
LM7824CT	

See Package Number T03B

TO-39 Metal Can Package (H)

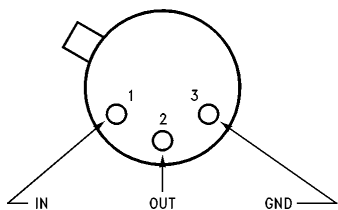

TL/H/7781-19

Top View

Metal Can Order Numbers†:

LM140H-5.0/883	LM140H-6.0/883
LM140H-8.0/883	LM140H-12/883
LM140H-15/883	LM140H-24/883

See Package Number H03A

TO-263 Surface-Mount Package (S)

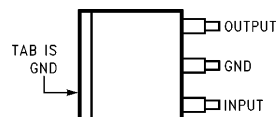

TL/H/7781-20

Top View



TL/H/7781-21

Side View

Surface-Mount Package Order Numbers:

LM7805S	LM7812S
---------	---------

See Package Number TS3B

†The specifications for the LM140H/883 devices are not contained in this datasheet. If specifications for these devices are required, contact the National Semiconductor Sales Office/Distributors.

Physical Dimensions inches (millimeters)

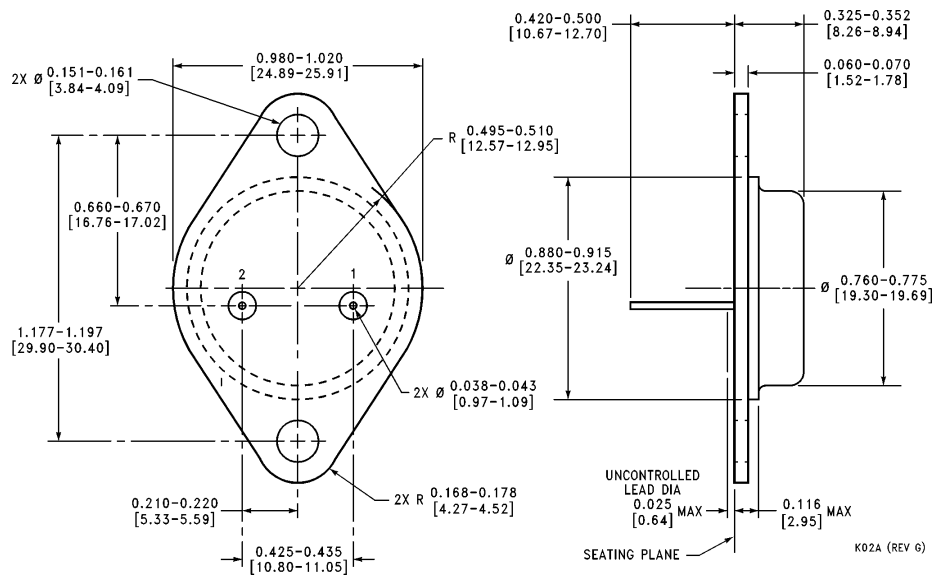

TO-3 Metal Can Package (K)
Order Number LM340AK-5.0, LM140K-5.0, LM340K-5.0, LM140K-12, LM340K-12,
LM140K-15, LM340K-15, LM7806CK, LM7808CK, LM7818CK or LM7824CK
NS Package Number K02A

Physical Dimensions inches (millimeters) (Continued)

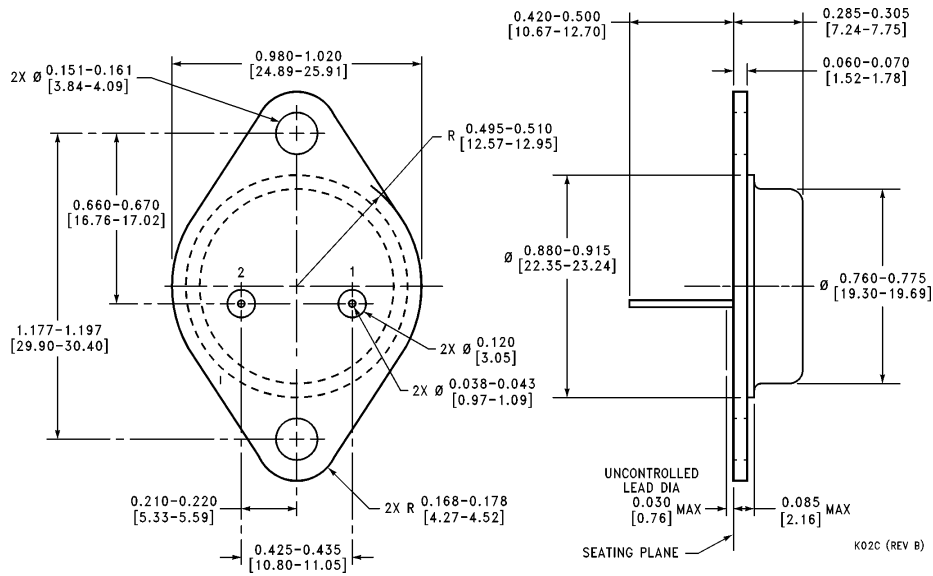

TO-3 Metal Can Package (K)

Mil-Aero Products

Order Number LM140AK-5.0/883, LM140K-5.0/883, LM140AK-12/883,
LM140K-12/883, LM140AK-15/883 or LM140K-15/883

NS Package Number K02C

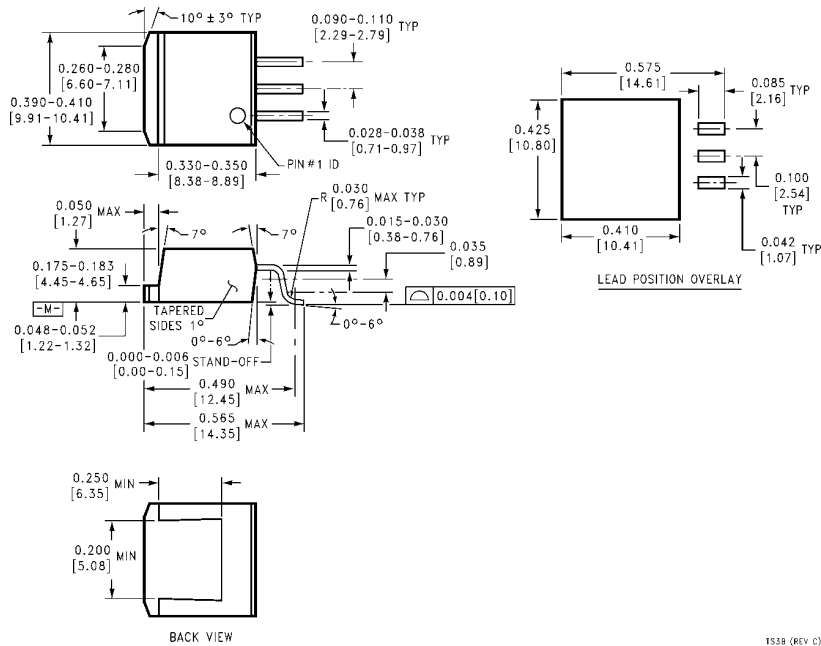

TO-263 Surface-Mount Package (S)

Order Number LM7805S or LM7812S

NS Package Number TS3B

Physical Dimensions inches (millimeters) (Continued)

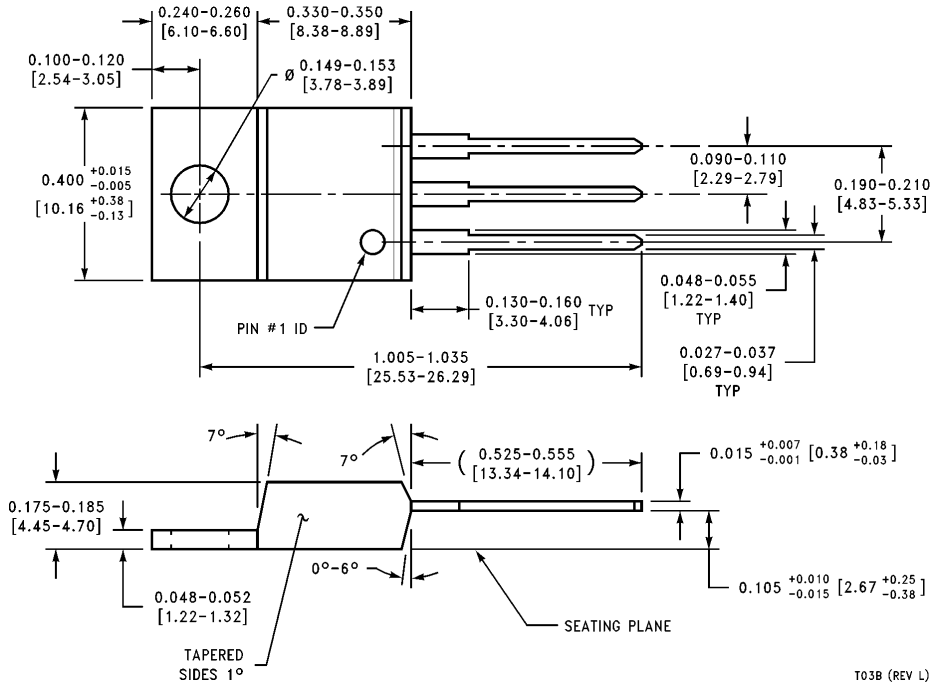

TO-220 Power Package (T)

T03B (REV L)

Order Number LM340AT/LM340T-5.0, LM340AT/LM340T-12, LM340AT/LM340T-15, LM7805CT, LM7812CT, LM7815CT, LM7806CT, LM7808CT, LM7818CT or LM7824CT
NS Package Number T03B

LIFE SUPPORT POLICY

NATIONAL'S PRODUCTS ARE NOT AUTHORIZED FOR USE AS CRITICAL COMPONENTS IN LIFE SUPPORT DEVICES OR SYSTEMS WITHOUT THE EXPRESS WRITTEN APPROVAL OF THE PRESIDENT OF NATIONAL SEMICONDUCTOR CORPORATION. As used herein:

1. Life support devices or systems are devices or systems which, (a) are intended for surgical implant into the body, or (b) support or sustain life, and whose failure to perform, when properly used in accordance with instructions for use provided in the labeling, can be reasonably expected to result in a significant injury to the user.
2. A critical component is any component of a life support device or system whose failure to perform can be reasonably expected to cause the failure of the life support device or system, or to affect its safety or effectiveness.



National Semiconductor Corporation
1111 West Bardin Road
Arlington, TX 76017
Tel: (800) 272-9959
Fax: (800) 737-7018

National Semiconductor Europe
Fax: (+49) 0-180-530 85 86
Email: cnjwge@tevm2.nsc.com
Deutsch Tel: (+49) 0-180-530 85 85
English Tel: (+49) 0-180-532 78 32
Français Tel: (+49) 0-180-532 93 58
Italiano Tel: (+49) 0-180-534 16 80

National Semiconductor Hong Kong Ltd.
19th Floor, Straight Block,
Ocean Centre, 5 Canton Rd.
Tsimshatsui, Kowloon
Hong Kong
Tel: (852) 2737-1600
Fax: (852) 2736-9960

National Semiconductor Japan Ltd.
Tel: 81-043-299-2309
Fax: 81-043-299-2408

National does not assume any responsibility for use of any circuitry described, no circuit patent licenses are implied and National reserves the right at any time without notice to change said circuitry and specifications.