

# 5V RS232 Transceiver with Advanced Power Management and One Receiver Active in Shutdown

## FEATURES

- One Receiver Remains Active While in Shutdown
- ESD Protection over  $\pm 15\text{kV}$
- Uses Small Capacitors:  $0.1\mu\text{F}$ ,  $0.2\mu\text{F}$ ,  $1.0\mu\text{F}$
- $60\mu\text{A}$  Supply Current in Shutdown
- Pin Compatible with LT1137A
- 120kBaod Operation for  $R_L = 3\text{k}$ ,  $C_L = 2500\text{pF}$
- 250kBaod Operation for  $R_L = 3\text{k}$ ,  $C_L = 1000\text{pF}$
- Operates to 120kBaod
- CMOS Comparable Low Power 30mW
- Operates from a Single 5V Supply
- Easy PC Layout—Flowthrough Architecture
- Rugged Bipolar Design
- Outputs Assume a High Impedance State When Off or Powered Down
- Absolutely No Latchup
- Available in SO and SSOP Packages

## APPLICATIONS

- Notebook Computers
- Palmtop Computers

## DESCRIPTION

The LT<sup>®</sup>1237 is an advanced low power three driver, five receiver RS232 transceiver. Included on the chip is a shutdown pin for reducing supply current near zero. During shutdown one receiver remains active to detect incoming RS232 signals, for example, to wake up a system.

The LT1237 is fully compliant with all EIA RS232 specifications. New ESD structures on the chip allow the LT1237 to survive multiple  $\pm 15\text{kV}$  strikes, eliminating the need for costly TransZorbs<sup>®</sup> on the RS232 line pins.

The LT1237 operates in excess of 120kbaud even driving heavy capacitive loads. Two shutdown modes allow the driver outputs to be shut down separately from the receivers for more versatile control of the RS232 interface. During shutdown, drivers and receivers assume a high impedance state.

LT, LTC and LT are registered trademarks of Linear Technology Corporation. TransZorb is a registered trademark of General Instruments, GSI

## TYPICAL APPLICATION

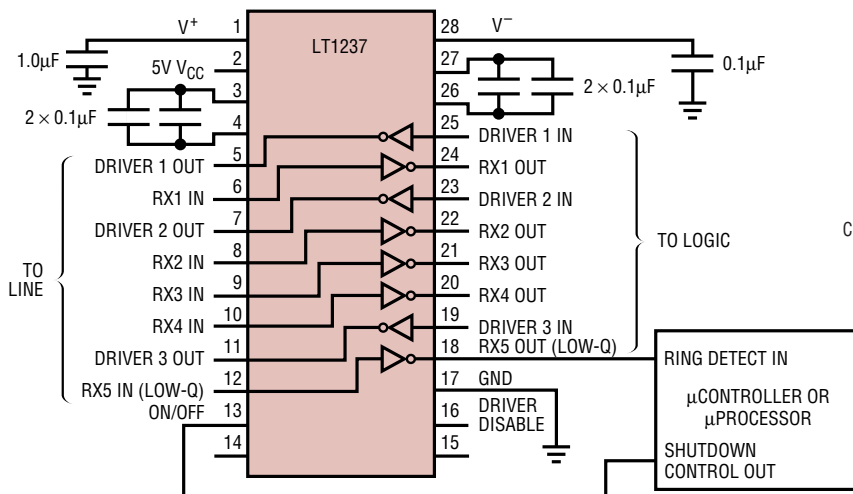

LT1237 TA01

## Output Waveforms

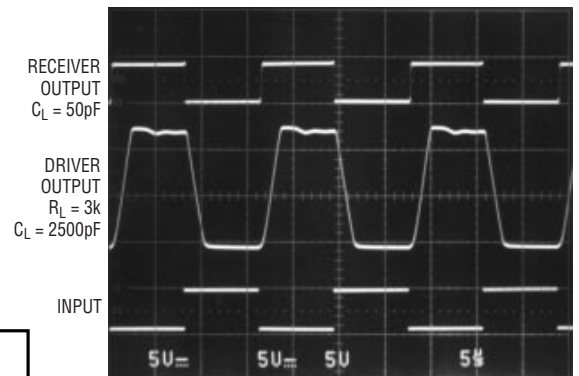

1237 TA02

## ABSOLUTE MAXIMUM RATINGS

(Note 1)

Supply Voltage ( $V_{CC}$ )	6V
$V^+$	13.2V
$V^-$	-13.2V
Input Voltage	
Driver	$V^-$ to $V^+$
Receiver	-30V to 30V
Output Voltage	
Driver	-30V to 30V
Receiver	-0.3V to $V_{CC} + 0.3V$
Short Circuit Duration	
$V^+$	30 sec
$V^-$	30 sec
Driver Output	Indefinite
Receiver Output	Indefinite
Operating Temperature Range	
LT1237C	0°C to 70°C
Storage Temperature Range	-65°C to 150°C
Lead Temperature (Soldering, 10 sec)	300°C

## PACKAGE/ORDER INFORMATION

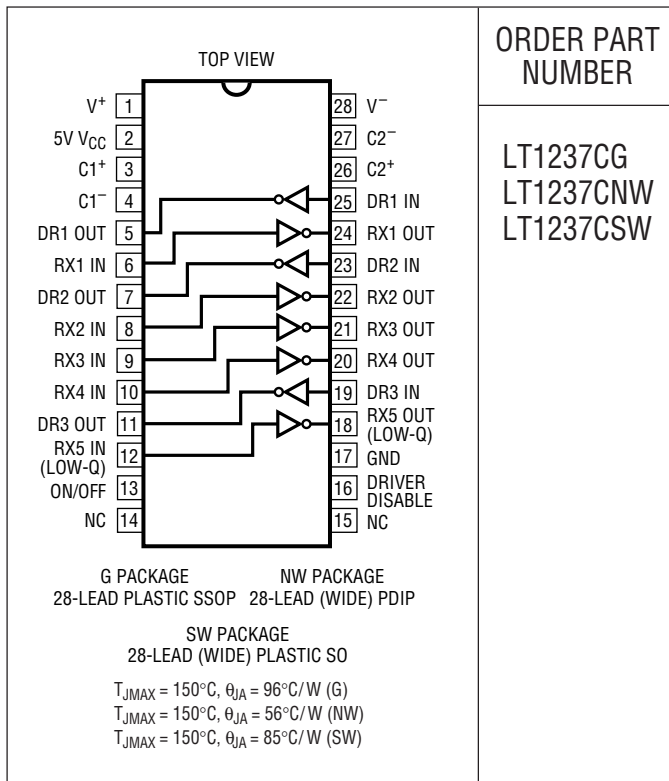

ORDER PART NUMBER

LT1237CG  
LT1237CNW  
LT1237CSW

Consult factory for Industrial and Military grade parts.

## ELECTRICAL CHARACTERISTICS

The ● denotes specifications which apply over the full operating temperature range, otherwise specifications are at  $T_A = 25^{\circ}C$ . (Note 2)

PARAMETER	CONDITIONS	MIN	TYP	MAX	UNITS
<b>Power Supply Generator</b>					
$V^+$ Output			7.9		V
$V^-$ Output			-7		V
Supply Current ( $V_{CC}$ )	$T_A = 25^{\circ}C$ (Note 3)		6	12	mA
		●	6	14	mA
Supply Current when OFF ( $V_{CC}$ )	Shutdown (Note 4)	●	0.06	0.15	mA
	Driver Disable		3.00		mA
Supply Rise Time Shutdown to Turn-On	$C1 = C2 = 0.2\mu F$ , $C^+ = 1.0\mu F, C^- = 0.1\mu F$		2		ms
ON/OFF Pin Thresholds	Input Low Level (Drivers Enabled)	0.8	1.2		V
	Input High Level (Drivers Disabled)		1.6	2.4	V
ON/OFF Pin Current	$0V \leq V_{ON/OFF} \leq 5V$	●	-15	80	$\mu A$
DRIVER DISABLE Pin Thresholds	Input Low Level (Drivers Enabled)	●	0.8	1.4	V
	Input High Level (Drivers Disabled)	●	1.4	2.4	V
DRIVER DISABLE Pin Current	$0V \leq V_{DRIVER\ DISABLE} \leq 5V$	●	-10	500	$\mu A$
Oscillator Frequency	Driver Outputs Loaded $R_L = 3k$		130		kHz

**ELECTRICAL CHARACTERISTICS** The ● denotes specifications which apply over the full operating temperature range, otherwise specifications are at  $T_A = 25^\circ\text{C}$ . (Note 2)

PARAMETER	CONDITIONS	MIN	TYP	MAX	UNITS	
<b>Any Driver</b>						
Output Voltage Swing	Load = 3k to GND Positive Negative	● ●	5.0 7.5 -6.3	-5.0	V V	
Logic Input Voltage Level	Input Low Level ( $V_{OUT} = \text{High}$ ) Input High Level ( $V_{OUT} = \text{Low}$ )	● ●	1.4 2.0 1.4	0.8	V V	
Logic Input Current	$0.8\text{V} \leq V_{IN} \leq 2\text{V}$	●	5	20	$\mu\text{A}$	
Output Short-Circuit Current	$V_{OUT} = 0\text{V}$		±9	17	$\text{mA}$	
Output Leakage Current	Shutdown $V_{OUT} = \pm 30\text{V}$ (Note 4)	●	10	100	$\mu\text{A}$	
Data Rate (Note 7)	$R_L = 3\text{k}, C_L = 2500\text{pF}$ $R_L = 3\text{k}, C_L = 1000\text{pF}$		120 250		kBaud kBaud	
Slew Rate	$R_L = 3\text{k}, C_L = 51\text{pF}$ $R_L = 3\text{k}, C_L = 2500\text{pF}$		15 4	30 7	$\text{V}/\mu\text{s}$ $\text{V}/\mu\text{s}$	
Propagation Delay	Output Transition $t_{HL}$ High to Low (Note 5) Output Transition $t_{LH}$ Low to High		0.6 0.5	1.3 1.3	$\mu\text{s}$ $\mu\text{s}$	
<b>Any Receiver</b>						
Input Voltage Thresholds	Input Low Threshold ( $V_{OUT} = \text{High}$ ) Input High Threshold ( $V_{OUT} = \text{Low}$ )		0.8 1.3 1.7	2.4	V V	
Hysteresis		●	0.1	0.4	1.0	V
Input Resistance	$V_{IN} = \pm 10\text{V}$		3	5	7	$\text{k}\Omega$
Output Leakage Current	Shutdown (Note 4) $0 \leq V_{OUT} \leq V_{CC}$	●	1	10	$\mu\text{A}$	
<b>Receivers 1, 2, 3, 4</b>						
Output Voltage	Output Low, $I_{OUT} = -1.6\text{mA}$ Output High, $I_{OUT} = 160\mu\text{A}$ ( $V_{CC} = 5\text{V}$ )	● ●	3.5	0.2 4.2	0.4	V V
Output Short-Circuit Current	Sinking Current, $V_{OUT} = V_{CC}$ Sourcing Current, $V_{OUT} = 0\text{V}$		-10 10	-20 20	$\text{mA}$ $\text{mA}$	
Propagation Delay	Output Transition $t_{HL}$ High to Low (Note 6) Output Transition $t_{LH}$ Low to High		250 350	600 600	ns ns	
<b>Receiver 5 (LOW <math>I_{SUPPLY\ RX}</math>)</b>						
Output Voltage	Output Low, $I_{OUT} = -500\mu\text{A}$ Output High, $I_{OUT} = 160\mu\text{A}$ ( $V_{CC} = 5\text{V}$ )	● ●	3.5	0.2 4.2	0.4	V V
Output Short-Circuit Current	Sinking Current, $V_{OUT} = V_{CC}$ Sourcing Current, $V_{OUT} = 0\text{V}$		-2 2	-4 4	$\text{mA}$ $\text{mA}$	
Propagation Delay	Output Transition $t_{HL}$ High to Low (Note 6) Output Transition $t_{LH}$ Low to High		1.0 0.6	3 3	$\mu\text{s}$ $\mu\text{s}$	

**Note 1:** Absolute Maximum Ratings are those values beyond which the life of the device may be impaired.

**Note 2:** Testing done at  $V_{CC} = 5\text{V}$  and  $V_{ON/OFF} = 3\text{V}$ , unless otherwise specified.

**Note 3:** Supply current is measured as the average over several charge pump burst cycles.  $C^+ = 1.0\mu\text{F}$ ,  $C^- = 0.1\mu\text{F}$ ,  $C1 = C2 = 0.2\mu\text{F}$ . All outputs are open, with all driver inputs tied high.

**Note 4:** Measurements in shutdown are performed with  $V_{ON/OFF} \leq 0.1\text{V}$ . Supply current measurements using driver disable are performed with  $V_{DRIVER\ DISABLE} \geq 3\text{V}$ .

**Note 5:** For driver delay measurements,  $R_L = 3\text{k}$  and  $C_L = 51\text{pF}$ . Trigger points are set between the driver's input logic threshold and the output transition to the zero crossing ( $t_{HL} = 1.4\text{V}$  to  $0\text{V}$  and  $t_{LH} = 1.4\text{V}$  to  $0\text{V}$ ).

**Note 6:** For receiver delay measurements,  $C_L = 51\text{pF}$ . Trigger points are set between the receiver's input logic threshold and the output transition to standard TTL/CMOS logic threshold ( $t_{HL} = 1.3\text{V}$  to  $2.4\text{V}$  and  $t_{LH} = 1.7\text{V}$  to  $0.8\text{V}$ ).

**Note 7:** Data rate operation guaranteed by slew rate, short-circuit current and propagation delay tests.

# TYPICAL PERFORMANCE CHARACTERISTICS

**Driver Output Voltage**

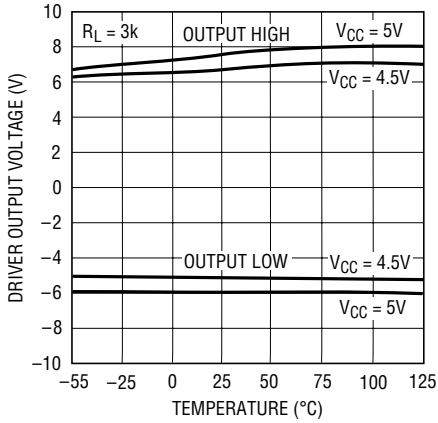

1237 G01

**Receiver Input Thresholds**

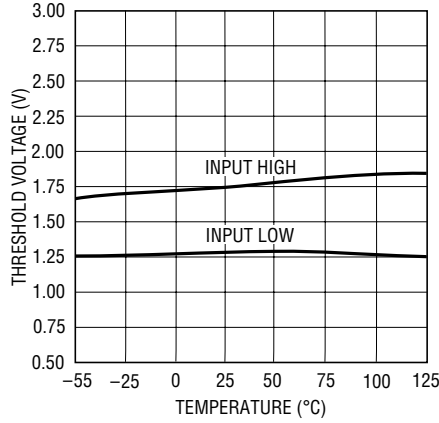

1237 G02

**Supply Current vs Data Rate**

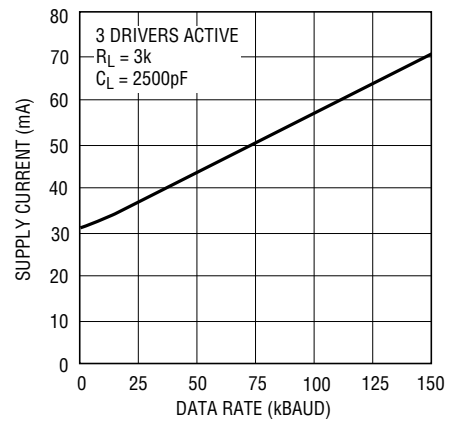

1237 G03

**Supply Current in Shutdown**

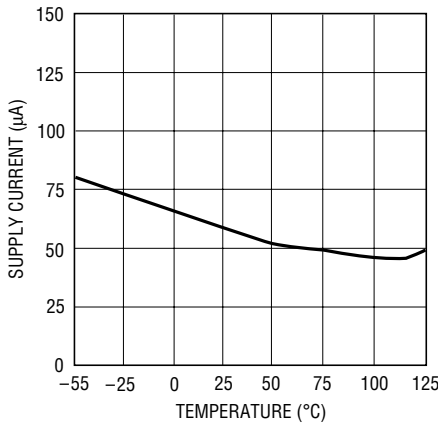

1237 G04

**Supply Current in Driver Disable**

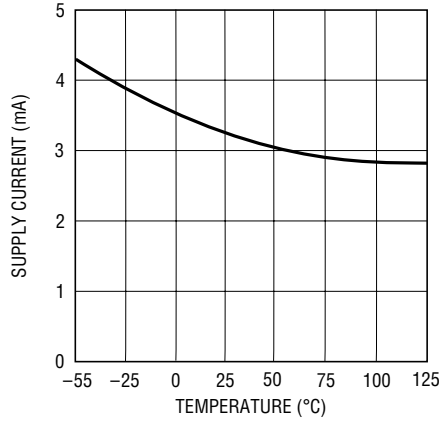

1237 G05

**DRIVER DISABLE Threshold**

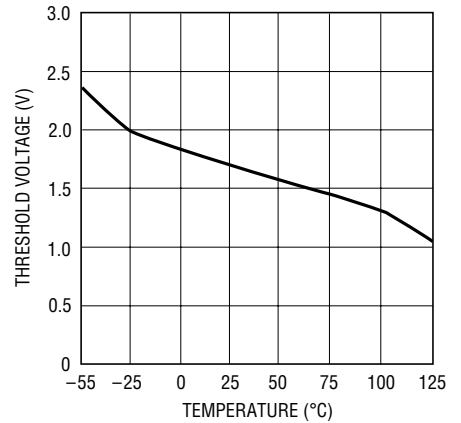

1237 G06

**ON/OFF Thresholds**

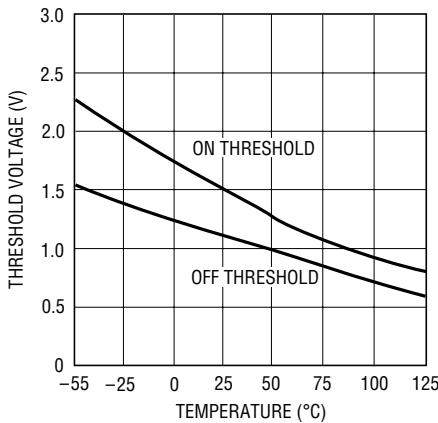

1237 G07

**Supply Current**

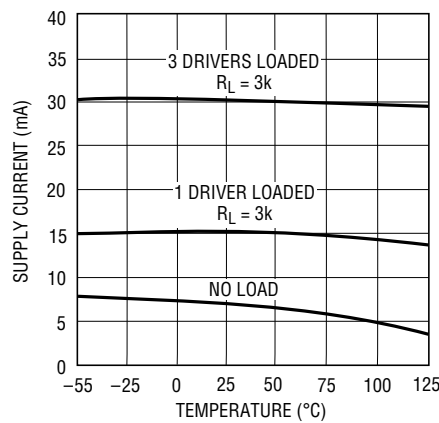

1237 G08

**Driver Leakage in Shutdown**

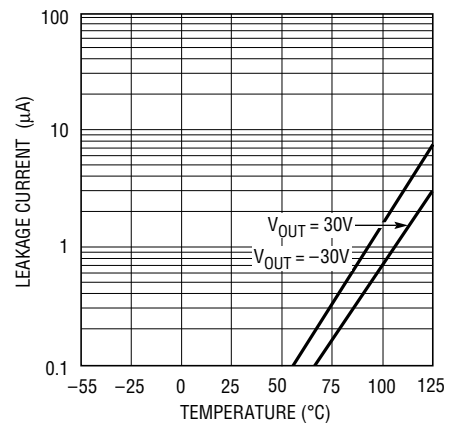

1237 G09

## TYPICAL PERFORMANCE CHARACTERISTICS

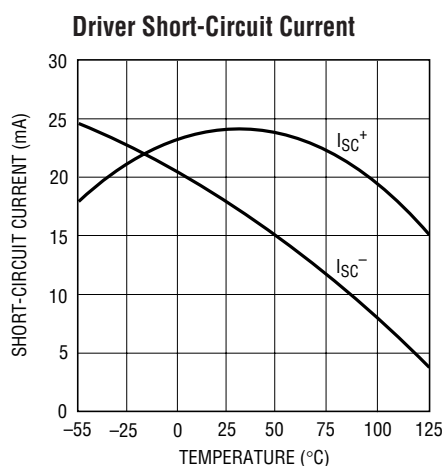

1237 G10

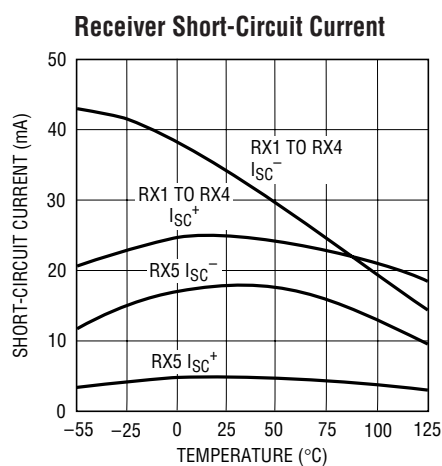

1237 G11

Receiver Output Waveforms

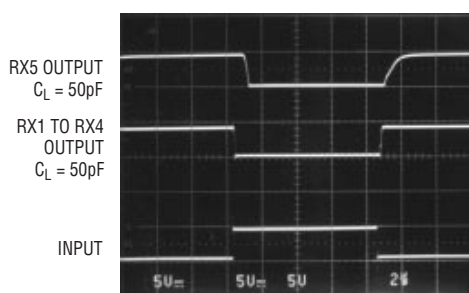

1237 G12

Driver Output Waveforms

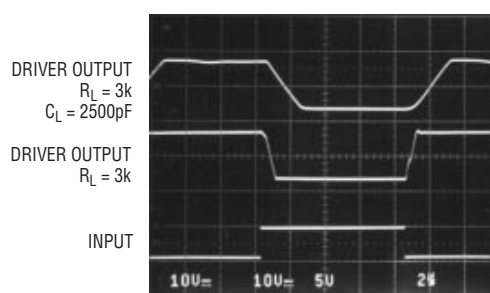

1237 G13

## PIN FUNCTIONS

**V<sub>CC</sub>**: 5V Input Supply Pin. This pin should be decoupled with a 0.1μF ceramic capacitor close to the package pin. Insufficient supply bypassing can result in low output drive levels and erratic charge pump operation.

**GND**: Ground Pin.

**ON/OFF**: TTL/CMOS Compatible Operating Mode Control. A logic low puts the device in the low power shutdown mode. All three drivers and four receivers (RX1, RX2, RX3, and RX4) assume a high impedance output state in shutdown. Only receiver RX5 remains active while the transceiver is in shutdown. The transceiver consumes only 60μA of supply current while in shutdown. A logic high fully enables the transceiver.

**DRIVER DISABLE**: This pin provides an alternate control for the charge pump and RS232 drivers. A logic high on this pin shuts down the charge pump and places all driver

outputs in a high impedance state. All five receivers remain active under these conditions. Floating the driver disable pin or driving it to a logic low level fully enables the transceiver. A logic low on the ON/OFF pin supersedes the state of the DRIVER DISABLE pin. Supply current drops to 3mA when in driver disable mode.

**V<sup>+</sup>**: Positive Supply Output (RS232 Drivers).  $V^+ \approx 2V_{CC} - 1.5V$ . This pin requires an external charge storage capacitor  $C \geq 1.0\mu F$ , tied to ground or  $V_{CC}$ . Larger value capacitors may be used to reduce supply ripple. The ratio of the capacitors on  $V^+$  and  $V^-$  should be greater than 5 to 1.

**V<sup>-</sup>**: Negative Supply Output (RS232 Drivers).  $V^- \approx -(2V_{CC} - 2.5V)$ . This pin requires an external charge storage capacitor  $C \geq 0.1\mu F$ . See the Applications Information section for guidance in choosing filter capacitors for  $V^+$  and  $V^-$ .

## PIN FUNCTIONS

**C1<sup>+</sup>, C1<sup>-</sup>, C2<sup>+</sup>, C2<sup>-</sup>:** Commutating Capacitor Inputs, require two external capacitors  $C \geq 0.2\mu\text{F}$ : one from C1<sup>+</sup> to C1<sup>-</sup>, and another from C2<sup>+</sup> to C2<sup>-</sup>. The capacitor’s effective series resistance should be less than  $2\Omega$ . For  $C \geq 1\mu\text{F}$ , low ESR tantalum capacitors work well in this application, although small value ceramic capacitors may be used with a minimal reduction in charge pump compliance.

**DRIVER IN:** RS232 Driver Input Pins. These inputs are TTL/CMOS compatible. Inputs should not be allowed to float. Tie unused inputs to  $V_{CC}$ .

**DRIVER OUT:** Driver Outputs at RS232 Voltage Levels. Driver output swing meets RS232 levels for loads up to 3k. Slew rates are controlled for lightly loaded lines. Output current capability is sufficient for load conditions up to 2500pF. Outputs are in a high impedance state when in shutdown mode,  $V_{CC} = 0\text{V}$ , or when the DRIVER DISABLE pin is active. Outputs are fully short-circuit protected from  $V^- + 30\text{V}$  to  $V^+ - 30\text{V}$ . Applying higher voltages will not damage the device if the overdrive is moderately current limited. Short circuits on one output can load the power supply generator and may disrupt the signal levels of the other outputs. The driver outputs are protected against ESD to  $\pm 15\text{kV}$  for human body model discharges,  $\pm 8\text{kV}$  for IEC 1000-4-2 contact mode discharges and  $\pm 15\text{kV}$  for IEC 1000-4-2 air gap discharges.

**RX IN:** Receiver Inputs. These pins accept RS232 level signals ( $\pm 30\text{V}$ ) into a protected 5k terminating resistor. The receiver inputs are protected against ESD to  $\pm 15\text{kV}$  for human body model discharges,  $\pm 8\text{kV}$  for IEC 1000-4-2 contact mode discharges and  $\pm 15\text{kV}$  for IEC 1000-4-2 air gap discharges. Each receiver provides 0.4V of hysteresis for noise immunity. Open receiver inputs assume a logic low state.

**RX OUT:** Receiver Outputs with TTL/CMOS Voltage Levels. Outputs RX1, RX2, RX3, and RX4 are in a high impedance state when in shutdown mode to allow data line sharing. Outputs, including LOW-Q RX OUT, are fully short-circuit protected to ground or  $V_{CC}$  with the power on, off, or in shutdown mode.

**LOW Q-CURRENT RX IN:** Low Power Receiver Input. This special receiver remains active when the part is in shutdown mode, consuming typically  $60\mu\text{A}$ . This receiver has the same 5k input impedance and  $\pm 10\text{kV}$  ESD protection characteristics as the other receivers.

**LOW Q-CURRENT RX OUT:** Low Power Receiver Output. This pin produces the same TTL/CMOS output voltage levels as receivers RX1, RX2, RX3, and RX4 with slightly decreased speed and short-circuit current. Data rates to 120kbaud are supported by this receiver.

## ESD PROTECTION

The RS232 line inputs of the LT1237 have on-chip protection from ESD transients up to  $\pm 15\text{kV}$  for human body discharges,  $\pm 8\text{kV}$  for IEC 1000-4-2 contact mode discharges and  $\pm 15\text{kV}$  for IEC 1000-4-2 air gap discharges. The protection structures act to divert the static discharge safely to system ground. In order for the ESD protection to function effectively, the power supply and ground pins of the LT1237 must be connected to ground through low impedances. The power supply decoupling capacitors and charge pump storage capacitors provide this low impedance in normal application of the circuit. The only constraint is that low ESR capacitors must be used for bypassing and charge storage. ESD testing must be done with pins  $V_{CC}$ ,  $V_L$ ,  $V^+$ ,  $V^-$  and GND shorted to ground or connected with low ESR capacitors.

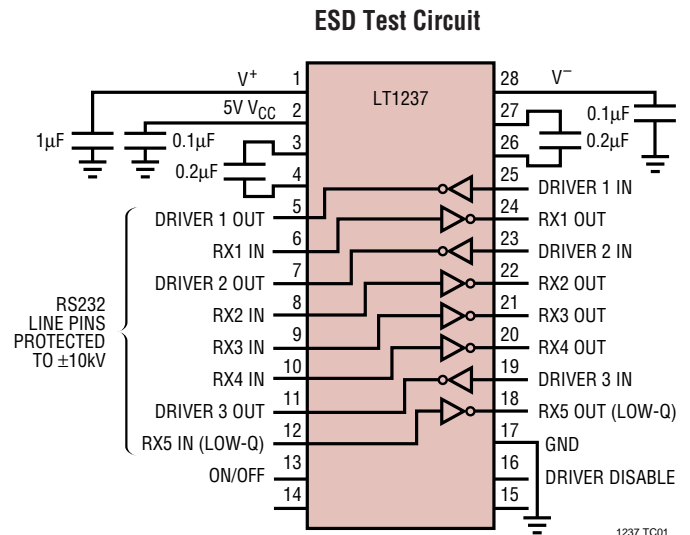

## APPLICATIONS INFORMATION

### Storage Capacitor Selection

The  $V^+$  and  $V^-$  storage capacitors must be chosen carefully to insure low ripple and stable operation. The LT1237 charge pump operates in a power efficient Burst Mode™ operation. When storage capacitor voltage drops below a preset threshold, the oscillator is gated on until  $V^+$  and  $V^-$  are boosted up to levels exceeding a second threshold. The oscillator then turns off, and current is supplied from the  $V^+$  and  $V^-$  storage capacitors.

The  $V^-$  potential is monitored to control charge pump operation. It is therefore important to insure lower  $V^+$  ripple than  $V^-$  ripple, or erratic operation of the charge pump will result. Proper operation is insured in most applications by choosing the  $V^+$  filter capacitor to be at least 5 times the  $V^-$  filter capacitor value. If  $V^+$  is more heavily loaded than  $V^-$ , a larger ratio may be needed.

The  $V^-$  filter capacitor should be selected to obtain low ripple when the drivers are loaded, forcing the charge pump into continuous mode. A minimum value  $0.1\mu\text{F}$  is suggested.

Do not attempt to reduce  $V^-$  ripple when the charge pump is in discontinuous Burst Mode operation. The ripple in this mode is determined by internal comparator thresholds. Larger storage capacitor values increase the burst period, and do not reduce ripple amplitude.

### Power Saving Operational Modes

The LT1237 has both shutdown and driver disable operating modes. These operating modes can optimize power consumption based upon applications needs.

The On/Off shutdown control turns off all circuitry except for Low-Q RX5. When RX5 detects a signal, this information can be used to wake up the system for full operation.

If more than one line must be monitored, the driver disable mode provides a power efficient operating option. The driver disable mode turns off the charge pump and RS232 drivers, but keeps all five receivers active. Power consumption in driver disable mode is 3mA from  $V_{CC}$ .

Burst Mode is a trademark of Linear Technology Corporation

## PACKAGE DESCRIPTION Dimensions in inches (millimeters) unless otherwise noted.

### G Package 28-Lead Plastic SSOP (0.209) (LTC DWG # 05-08-1640)

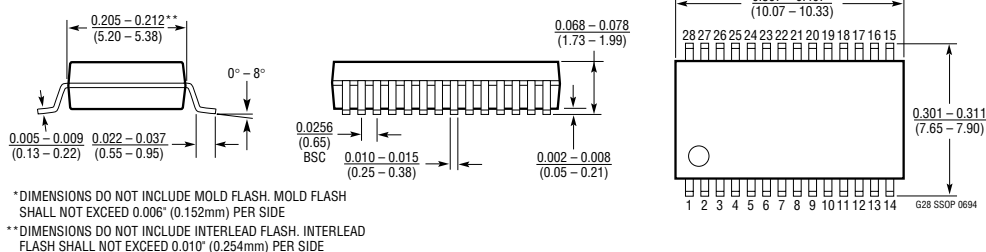

### NW Package 28-Lead PDIP (Wide 0.600) (LTC DWG # 05-08-1520)

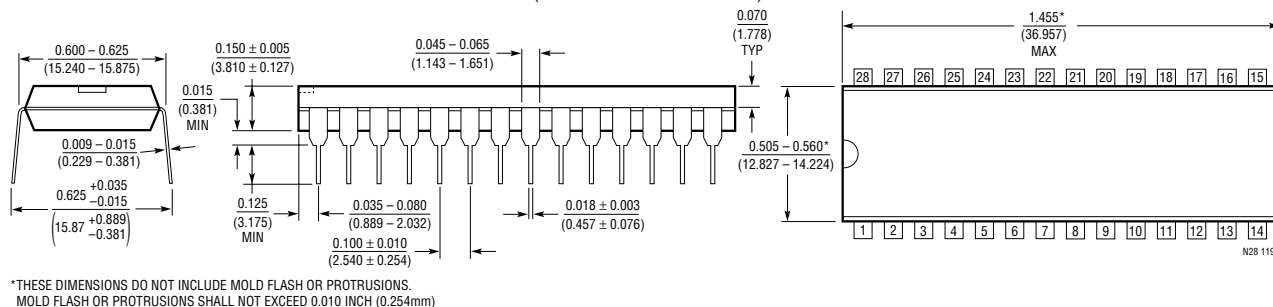

**PACKAGE DESCRIPTION** Dimensions in inches (millimeters) unless otherwise noted.

**SW Package**  
**28-Lead Plastic Small Outline (Wide 0.300)**  
 (LTC DWG # 05-08-1620)

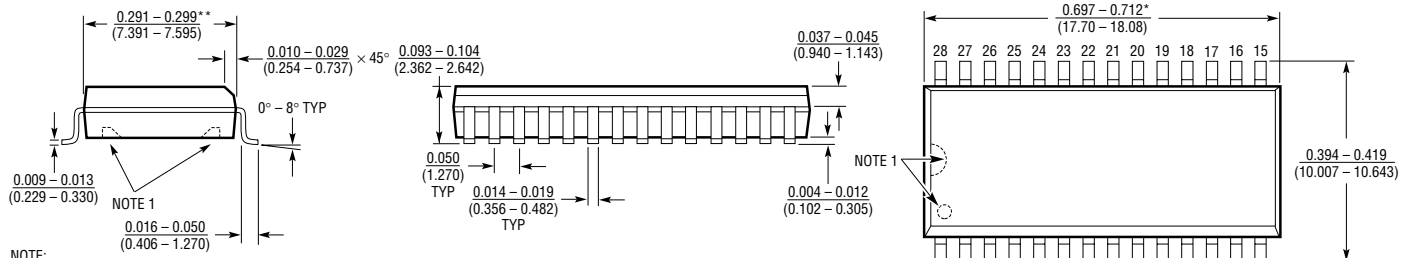

NOTE:  
 1. PIN 1 IDENT. NOTCH ON TOP AND CAVITIES ON THE BOTTOM OF PACKAGES ARE THE MANUFACTURING OPTIONS. THE PART MAY BE SUPPLIED WITH OR WITHOUT ANY OF THE OPTIONS  
 \*DIMENSION DOES NOT INCLUDE MOLD FLASH. MOLD FLASH SHALL NOT EXCEED 0.006" (0.152mm) PER SIDE  
 \*\*DIMENSION DOES NOT INCLUDE INTERLEAD FLASH. INTERLEAD FLASH SHALL NOT EXCEED 0.010" (0.254mm) PER SIDE

**TYPICAL APPLICATION**

**Typical Mouse Driving Application**

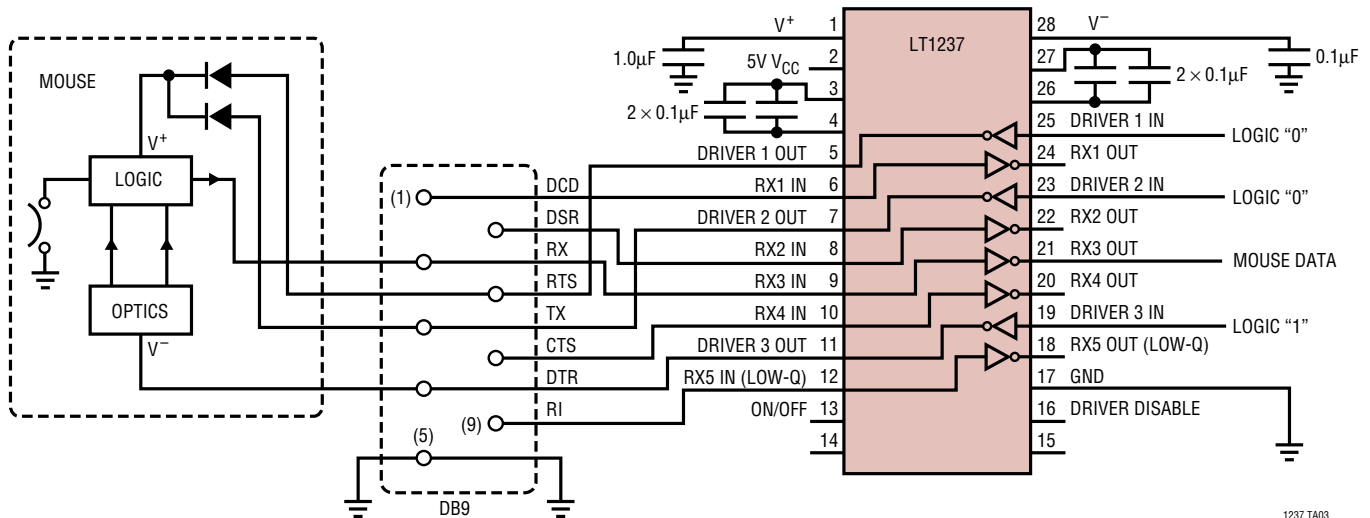

**RELATED PARTS**

PART NUMBER	DESCRIPTION	COMMENTS
LTC®485	Low Power RS485 Transceiver	
LT1137A	3Dx/5Rx RS232 Transceiver	15kV ESD
LTC1387	RS232/RS485 Multiprotocol Transceiver	
LT1780/LT1781	2Dx/2Rx RS232 Transceiver	15kV ESD
LT1785/LT1791	60V Fault Tolerant RS485 Transceiver	15kV ESD