

# 74HC1G86; 74HCT1G86

2-input EXCLUSIVE-OR gate

Rev. 04 — 20 July 2007

Product data sheet

## 1. General description

74HC1G86 and 74HCT1G86 are high-speed Si-gate CMOS devices. They provide a 2-input EXCLUSIVE-OR function.

The HC device has CMOS input switching levels and supply voltage range 2 V to 6 V.

The HCT device has TTL input switching levels and supply voltage range 4.5 V to 5.5 V.

The standard output currents are half those of the 74HC/HCT86.

## 2. Features

- Symmetrical output impedance
- High noise immunity
- Low power dissipation
- Balanced propagation delays
- SOT353-1 and SOT753 package options
- Specified from -40 °C to +125 °C

## 3. Ordering information

Table 1. Ordering information

Type number	Package			
	Temperature range	Name	Description	Version
74HC1G86GW 74HCT1G86GW	-40 °C to +125 °C	TSSOP5	plastic thin shrink small outline package; 5 leads; body width 1.25 mm	SOT353-1
74HC1G86GV 74HCT1G86GV	-40 °C to +125 °C	SC-74A	plastic surface-mounted package; 5 leads	SOT753

## 4. Marking

Table 2. Marking codes

Type number	Marking
74HC1G86GW	HH
74HCT1G86GW	TH
74HC1G86GV	H86
74HCT1G86GV	T86

## 5. Functional diagram

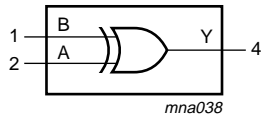

Fig 1. Logic symbol

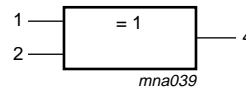

Fig 2. IEC logic symbol

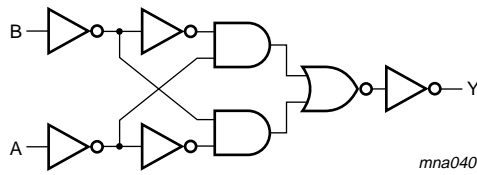

Fig 3. Logic diagram

## 6. Pinning information

### 6.1 Pinning

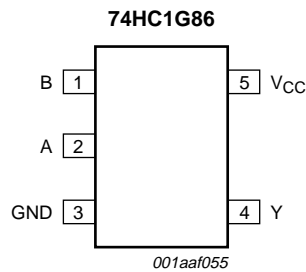

Fig 4. Pin configuration

### 6.2 Pin description

Table 3. Pin description

Symbol	Pin	Description
B	1	data input
A	2	data input
GND	3	ground (0 V)
Y	4	data output
V <sub>CC</sub>	5	supply voltage

## 7. Functional description

**Table 4. Function table**

H = HIGH voltage level; L = LOW voltage level

Inputs		Output
A	B	Y
L	L	L
L	H	H
H	L	H
H	H	L

## 8. Limiting values

**Table 5. Limiting values**

In accordance with the Absolute Maximum Rating System (IEC 60134). Voltages are referenced to GND (ground = 0 V). [\[1\]](#)

Symbol	Parameter	Conditions	Min	Max	Unit
V <sub>CC</sub>	supply voltage		-0.5	+7.0	V
I <sub>IK</sub>	input clamping current	V <sub>I</sub> < -0.5 V or V <sub>I</sub> > V <sub>CC</sub> + 0.5 V	-	±20	mA
I <sub>OK</sub>	output clamping current	V <sub>O</sub> < -0.5 V or V <sub>O</sub> > V <sub>CC</sub> + 0.5 V	-	±20	mA
I <sub>O</sub>	output current	-0.5 V < V <sub>O</sub> < V <sub>CC</sub> + 0.5 V	-	±12.5	mA
I <sub>CC</sub>	supply current		-	25	mA
I <sub>GND</sub>	ground current		-25	-	mA
T <sub>stg</sub>	storage temperature		-65	+150	°C
P <sub>tot</sub>	total power dissipation	T <sub>amb</sub> = -40 °C to +125 °C	<a href="#">[2]</a> -	200	mW

[1] The input and output voltage ratings may be exceeded if the input and output current ratings are observed.

[2] Above 55 °C the value of P<sub>tot</sub> derates linearly with 2.5 mW/K.

## 9. Recommended operating conditions

**Table 6. Recommended operating conditions**

Voltages are referenced to GND (ground = 0 V).

Symbol	Parameter	Conditions	74HC1G86			74HCT1G86			Unit
			Min	Typ	Max	Min	Typ	Max	
V <sub>CC</sub>	supply voltage		2.0	5.0	6.0	4.5	5.0	5.5	V
V <sub>I</sub>	input voltage		0	-	V <sub>CC</sub>	0	-	V <sub>CC</sub>	V
V <sub>O</sub>	output voltage		0	-	V <sub>CC</sub>	0	-	V <sub>CC</sub>	V
T <sub>amb</sub>	ambient temperature		-40	+25	+125	-40	+25	+125	°C
Δt/ΔV	input transition rise and fall rate	V <sub>CC</sub> = 2.0 V	-	-	625	-	-	-	ns/V
		V <sub>CC</sub> = 4.5 V	-	-	139	-	-	139	ns/V
		V <sub>CC</sub> = 6.0 V	-	-	83	-	-	-	ns/V

10. Static characteristics

Table 7. Static characteristics

Voltages are referenced to GND (ground = 0 V). All typical values are measured at  $T_{amb} = 25\text{ }^{\circ}\text{C}$ .

Symbol	Parameter	Conditions	-40 °C to +85 °C			-40 °C to +125 °C		Unit
			Min	Typ	Max	Min	Max	
<b>For type 74HC1G86</b>								
V <sub>IH</sub>	HIGH-level input voltage	V <sub>CC</sub> = 2.0 V	1.5	1.2	-	1.5	-	V
		V <sub>CC</sub> = 4.5 V	3.15	2.4	-	3.15	-	V
		V <sub>CC</sub> = 6.0 V	4.2	3.2	-	4.2	-	V
V <sub>IL</sub>	LOW-level input voltage	V <sub>CC</sub> = 2.0 V	-	0.8	0.5	-	0.5	V
		V <sub>CC</sub> = 4.5 V	-	2.1	1.35	-	1.35	V
		V <sub>CC</sub> = 6.0 V	-	2.8	1.8	-	1.8	V
V <sub>OH</sub>	HIGH-level output voltage	V <sub>I</sub> = V <sub>IH</sub> or V <sub>IL</sub>						
		I <sub>O</sub> = -20 μA; V <sub>CC</sub> = 2.0 V	1.9	2.0	-	1.9	-	V
		I <sub>O</sub> = -20 μA; V <sub>CC</sub> = 4.5 V	4.4	4.5	-	4.4	-	V
		I <sub>O</sub> = -20 μA; V <sub>CC</sub> = 6.0 V	5.9	6.0	-	5.9	-	V
		I <sub>O</sub> = -2.0 mA; V <sub>CC</sub> = 4.5 V	4.13	4.32	-	3.7	-	V
V <sub>OL</sub>	LOW-level output voltage	V <sub>I</sub> = V <sub>IH</sub> or V <sub>IL</sub>						
		I <sub>O</sub> = 20 μA; V <sub>CC</sub> = 2.0 V	-	0	0.1	-	0.1	V
		I <sub>O</sub> = 20 μA; V <sub>CC</sub> = 4.5 V	-	0	0.1	-	0.1	V
		I <sub>O</sub> = 20 μA; V <sub>CC</sub> = 6.0 V	-	0	0.1	-	0.1	V
		I <sub>O</sub> = 2.0 mA; V <sub>CC</sub> = 4.5 V	-	0.15	0.33	-	0.4	V
I <sub>I</sub>	input leakage current	V <sub>I</sub> = V <sub>CC</sub> or GND; V <sub>CC</sub> = 6.0 V	-	-	1.0	-	1.0	μA
		V <sub>I</sub> = V <sub>CC</sub> or GND; I <sub>O</sub> = 0 A; V <sub>CC</sub> = 6.0 V	-	-	10	-	20	μA
C <sub>I</sub>	input capacitance		-	1.5	-	-	-	pF
<b>For type 74HCT1G86</b>								
V <sub>IH</sub>	HIGH-level input voltage	V <sub>CC</sub> = 4.5 V to 5.5 V	2.0	1.6	-	2.0	-	V
V <sub>IL</sub>	LOW-level input voltage	V <sub>CC</sub> = 4.5 V to 5.5 V	-	1.2	0.8	-	0.8	V
V <sub>OH</sub>	HIGH-level output voltage	V <sub>I</sub> = V <sub>IH</sub> or V <sub>IL</sub>						
		I <sub>O</sub> = -20 μA; V <sub>CC</sub> = 4.5 V	4.4	4.5	-	4.4	-	V
		I <sub>O</sub> = -2.0 mA; V <sub>CC</sub> = 4.5 V	4.13	4.32	-	3.7	-	V
V <sub>OL</sub>	LOW-level output voltage	V <sub>I</sub> = V <sub>IH</sub> or V <sub>IL</sub>						
		I <sub>O</sub> = 20 μA; V <sub>CC</sub> = 4.5 V	-	0	0.1	-	0.1	V
		I <sub>O</sub> = 2.0 mA; V <sub>CC</sub> = 4.5 V	-	0.15	0.33	-	0.4	V
I <sub>I</sub>	input leakage current	V <sub>I</sub> = V <sub>CC</sub> or GND; V <sub>CC</sub> = 5.5 V	-	-	1.0	-	1.0	μA

**Table 7. Static characteristics ...continued**

Voltages are referenced to GND (ground = 0 V). All typical values are measured at  $T_{amb} = 25\text{ }^{\circ}\text{C}$ .

Symbol	Parameter	Conditions	-40 °C to +85 °C			-40 °C to +125 °C		Unit
			Min	Typ	Max	Min	Max	
$I_{CC}$	supply current	$V_I = V_{CC}$ or GND; $I_O = 0\text{ A}$ ; $V_{CC} = 5.5\text{ V}$	-	-	10	-	20	$\mu\text{A}$
$\Delta I_{CC}$	additional supply current	per input; $V_{CC} = 4.5\text{ V}$ to $5.5\text{ V}$ ; $V_I = V_{CC} - 2.1\text{ V}$ ; $I_O = 0\text{ A}$	-	-	500	-	850	$\mu\text{A}$
$C_I$	input capacitance		-	1.5	-	-	-	pF

## 11. Dynamic characteristics

**Table 8. Dynamic characteristics**

$GND = 0\text{ V}$ ;  $t_r = t_f \leq 6.0\text{ ns}$ ; All typical values are measured at  $T_{amb} = 25\text{ }^{\circ}\text{C}$ . For test circuit see [Figure 6](#)

Symbol	Parameter	Conditions	-40 °C to +85 °C			-40 °C to +125 °C		Unit
			Min	Typ	Max	Min	Max	

### For type 74HC1G86

$t_{pd}$	propagation delay	A and B to Y; see <a href="#">Figure 5</a>	[1]					
		$V_{CC} = 2.0\text{ V}$ ; $C_L = 50\text{ pF}$	-	22	115	-	135	ns
		$V_{CC} = 4.5\text{ V}$ ; $C_L = 50\text{ pF}$	-	11	23	-	27	ns
		$V_{CC} = 5.0\text{ V}$ ; $C_L = 15\text{ pF}$	-	9	-	-	-	ns
$C_{PD}$	power dissipation capacitance	$V_I = GND$ to $V_{CC}$	[2]	23	-	-	-	pF

### For type 74HCT1G86

$t_{pd}$	propagation delay	A and B to Y; see <a href="#">Figure 5</a>	[1]					
		$V_{CC} = 4.5\text{ V}$ ; $C_L = 50\text{ pF}$	-	13	23	-	27	ns
		$V_{CC} = 5.0\text{ V}$ ; $C_L = 15\text{ pF}$	-	10	-	-	-	ns
$C_{PD}$	power dissipation capacitance	$V_I = GND$ to $V_{CC} - 1.5\text{ V}$	[2]	23	-	-	-	pF

[1]  $t_{pd}$  is the same as  $t_{PLH}$  and  $t_{PHL}$ .

[2]  $C_{PD}$  is used to determine the dynamic power dissipation  $P_D$  ( $\mu\text{W}$ ).

$$P_D = C_{PD} \times V_{CC}^2 \times f_i + \sum (C_L \times V_{CC}^2 \times f_o) \text{ where:}$$

$f_i$  = input frequency in MHz

$f_o$  = output frequency in MHz

$C_L$  = output load capacitance in pF

$V_{CC}$  = supply voltage in Volts

$\sum (C_L \times V_{CC}^2 \times f_o)$  = sum of outputs

12. Waveforms

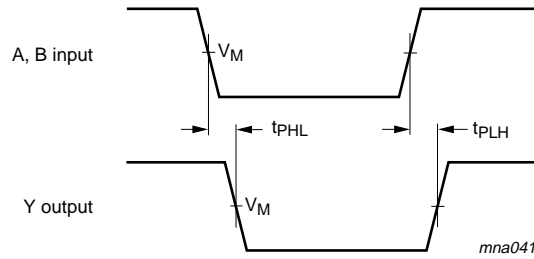

For 74HC1G86:  $V_M = 0.5 \times V_{CC}$ ;  $V_I = \text{GND to } V_{CC}$ .  
 For 74HCT1G86:  $V_M = 1.3 \text{ V}$ ;  $V_I = \text{GND to } 3.0 \text{ V}$ .

Fig 5. The input (A and B) to output (Y) propagation delays

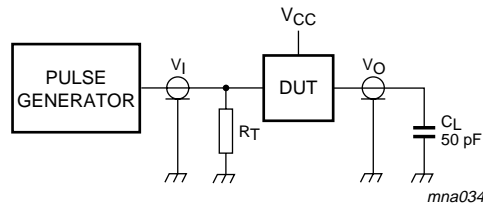

Test data is given in [Table 8](#). Definitions for test circuit:  
 $C_L$  = Load capacitance including jig and probe capacitance.  
 $R_T$  = Termination resistance should be equal to output impedance  $Z_o$  of the pulse generator.

Fig 6. Load circuitry for switching times

13. Package outline

TSSOP5: plastic thin shrink small outline package; 5 leads; body width 1.25 mm

SOT353-1

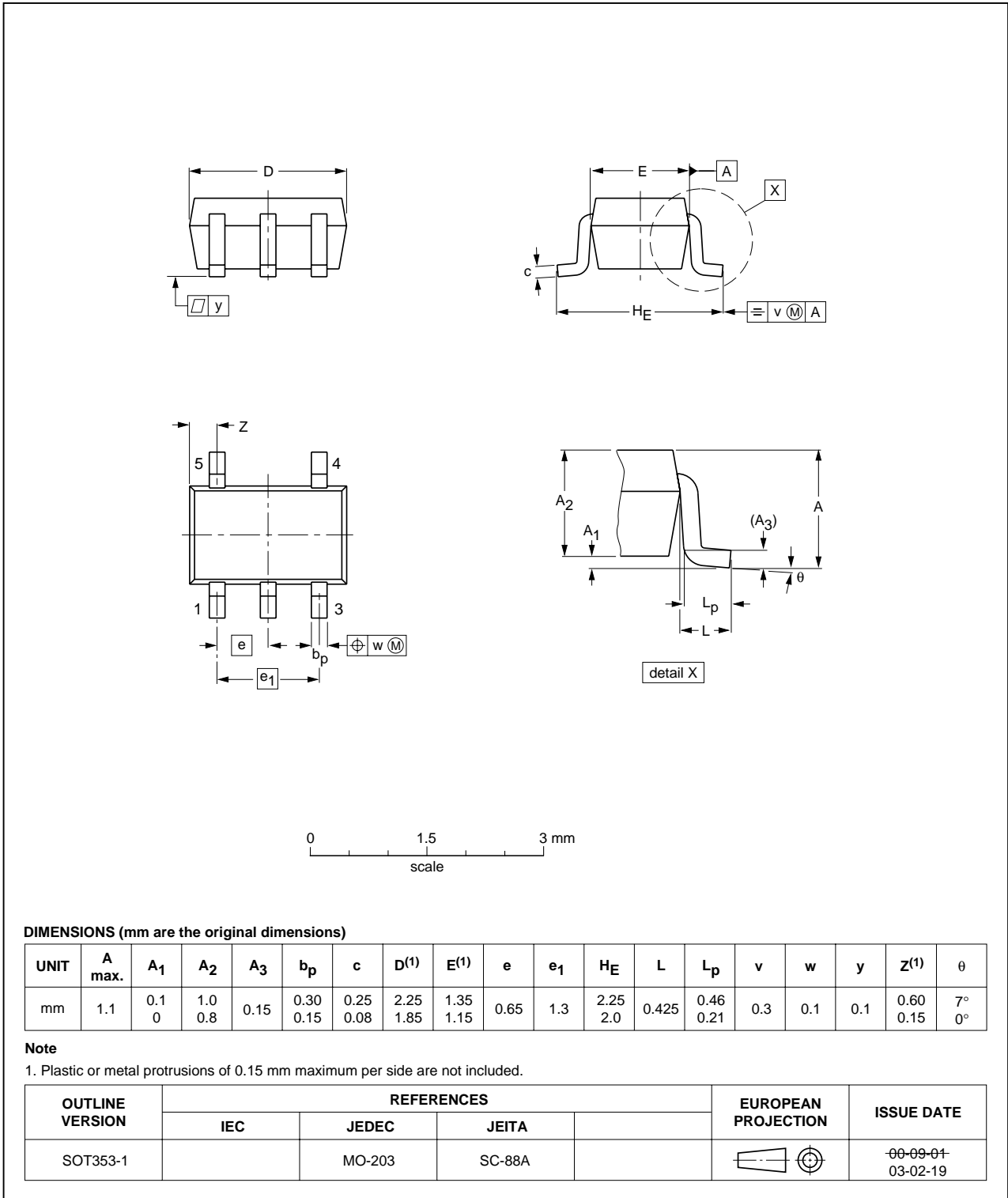

Fig 7. Package outline SOT353-1 (TSSOP5)

Plastic surface-mounted package; 5 leads

SOT753

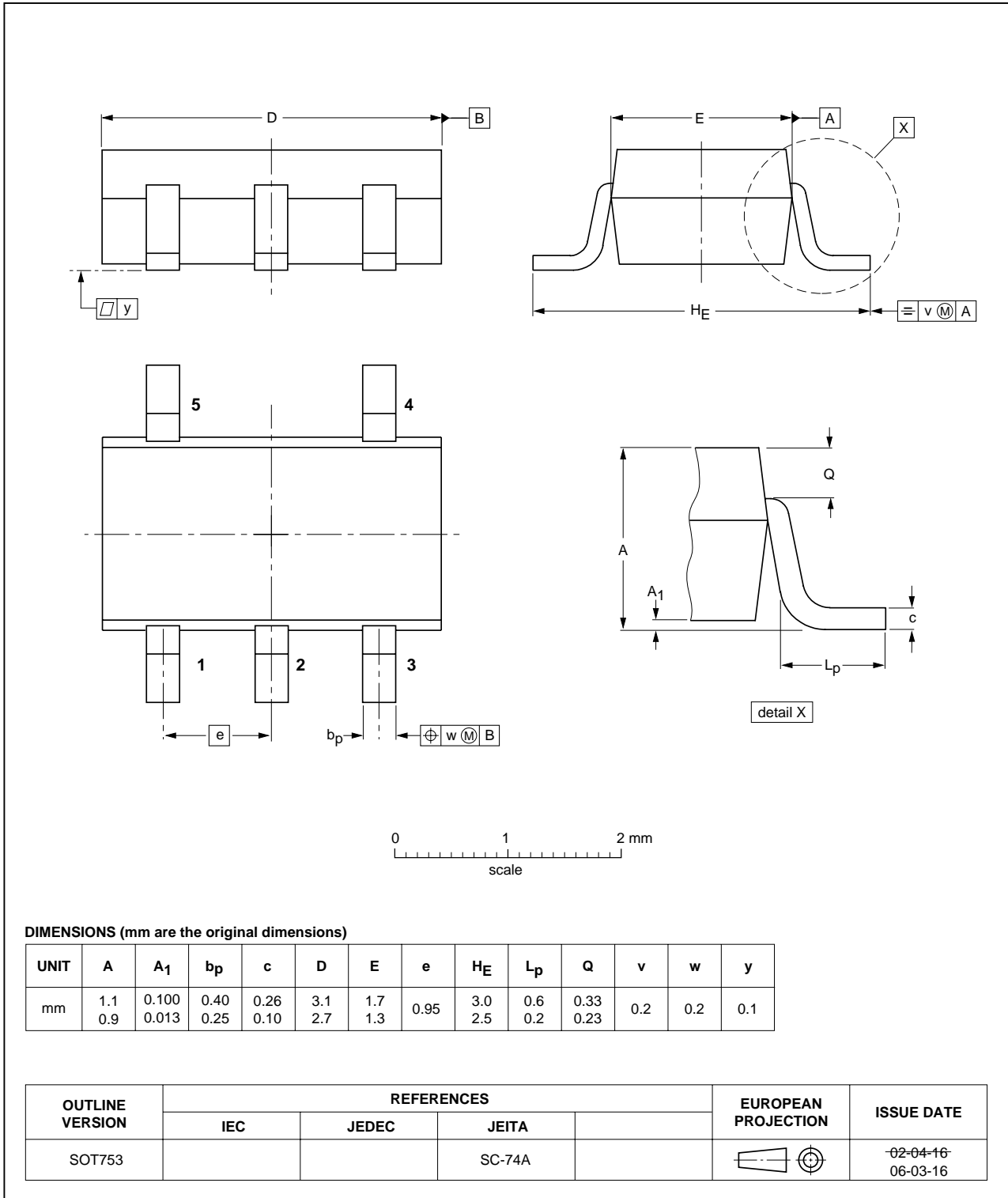

Fig 8. Package outline SOT753 (SC-74A)

## 14. Abbreviations

Table 9. Abbreviations

Acronym	Description
DUT	Device Under Test
TTL	Transistor-Transistor Logic

## 15. Revision history

Table 10. Revision history

Document ID	Release date	Data sheet status	Change notice	Supersedes
74HC_HCT1G86_4	20070720	Product data sheet	-	74HC_HCT1G86_3
Modifications:	<ul style="list-style-type: none"> <li>• The format of this data sheet has been redesigned to comply with the new identity guidelines of NXP Semiconductors.</li> <li>• Legal texts have been adapted to the new company name where appropriate.</li> <li>• Package SOT353 changed to SOT353-1 in <a href="#">Table 1</a> and <a href="#">Figure 7</a>.</li> <li>• Quick Reference Data and Soldering sections removed.</li> <li>• <a href="#">Section 2 "Features"</a> updated.</li> </ul>			
74HC_HCT1G86_3	20020515	Product specification	-	74HC_HCT1G86_2
74HC_HCT1G86_2	20010406	Product specification	-	74HC_HCT1G86_1
74HC_HCT1G86_1	19980805	Product specification	-	-

## 16. Legal information

### 16.1 Data sheet status

Document status <sup>[1][2]</sup>	Product status <sup>[3]</sup>	Definition
Objective [short] data sheet	Development	This document contains data from the objective specification for product development.
Preliminary [short] data sheet	Qualification	This document contains data from the preliminary specification.
Product [short] data sheet	Production	This document contains the product specification.

[1] Please consult the most recently issued document before initiating or completing a design.

[2] The term 'short data sheet' is explained in section "Definitions".

[3] The product status of device(s) described in this document may have changed since this document was published and may differ in case of multiple devices. The latest product status information is available on the Internet at URL <http://www.nxp.com>.

### 16.2 Definitions

**Draft** — The document is a draft version only. The content is still under internal review and subject to formal approval, which may result in modifications or additions. NXP Semiconductors does not give any representations or warranties as to the accuracy or completeness of information included herein and shall have no liability for the consequences of use of such information.

**Short data sheet** — A short data sheet is an extract from a full data sheet with the same product type number(s) and title. A short data sheet is intended for quick reference only and should not be relied upon to contain detailed and full information. For detailed and full information see the relevant full data sheet, which is available on request via the local NXP Semiconductors sales office. In case of any inconsistency or conflict with the short data sheet, the full data sheet shall prevail.

### 16.3 Disclaimers

**General** — Information in this document is believed to be accurate and reliable. However, NXP Semiconductors does not give any representations or warranties, expressed or implied, as to the accuracy or completeness of such information and shall have no liability for the consequences of use of such information.

**Right to make changes** — NXP Semiconductors reserves the right to make changes to information published in this document, including without limitation specifications and product descriptions, at any time and without notice. This document supersedes and replaces all information supplied prior to the publication hereof.

**Suitability for use** — NXP Semiconductors products are not designed, authorized or warranted to be suitable for use in medical, military, aircraft, space or life support equipment, nor in applications where failure or

malfunction of a NXP Semiconductors product can reasonably be expected to result in personal injury, death or severe property or environmental damage. NXP Semiconductors accepts no liability for inclusion and/or use of NXP Semiconductors products in such equipment or applications and therefore such inclusion and/or use is at the customer's own risk.

**Applications** — Applications that are described herein for any of these products are for illustrative purposes only. NXP Semiconductors makes no representation or warranty that such applications will be suitable for the specified use without further testing or modification.

**Limiting values** — Stress above one or more limiting values (as defined in the Absolute Maximum Ratings System of IEC 60134) may cause permanent damage to the device. Limiting values are stress ratings only and operation of the device at these or any other conditions above those given in the Characteristics sections of this document is not implied. Exposure to limiting values for extended periods may affect device reliability.

**Terms and conditions of sale** — NXP Semiconductors products are sold subject to the general terms and conditions of commercial sale, as published at <http://www.nxp.com/profile/terms>, including those pertaining to warranty, intellectual property rights infringement and limitation of liability, unless explicitly otherwise agreed to in writing by NXP Semiconductors. In case of any inconsistency or conflict between information in this document and such terms and conditions, the latter will prevail.

**No offer to sell or license** — Nothing in this document may be interpreted or construed as an offer to sell products that is open for acceptance or the grant, conveyance or implication of any license under any copyrights, patents or other industrial or intellectual property rights.

### 16.4 Trademarks

Notice: All referenced brands, product names, service names and trademarks are the property of their respective owners.

## 17. Contact information

For additional information, please visit: <http://www.nxp.com>

For sales office addresses, send an email to: [salesaddresses@nxp.com](mailto:salesaddresses@nxp.com)

## 18. Contents

<b>1</b>	<b>General description</b> .....	<b>1</b>
<b>2</b>	<b>Features</b> .....	<b>1</b>
<b>3</b>	<b>Ordering information</b> .....	<b>1</b>
<b>4</b>	<b>Marking</b> .....	<b>1</b>
<b>5</b>	<b>Functional diagram</b> .....	<b>2</b>
<b>6</b>	<b>Pinning information</b> .....	<b>2</b>
6.1	Pinning .....	2
6.2	Pin description .....	2
<b>7</b>	<b>Functional description</b> .....	<b>3</b>
<b>8</b>	<b>Limiting values</b> .....	<b>3</b>
<b>9</b>	<b>Recommended operating conditions</b> .....	<b>3</b>
<b>10</b>	<b>Static characteristics</b> .....	<b>4</b>
<b>11</b>	<b>Dynamic characteristics</b> .....	<b>5</b>
<b>12</b>	<b>Waveforms</b> .....	<b>6</b>
<b>13</b>	<b>Package outline</b> .....	<b>7</b>
<b>14</b>	<b>Abbreviations</b> .....	<b>9</b>
<b>15</b>	<b>Revision history</b> .....	<b>9</b>
<b>16</b>	<b>Legal information</b> .....	<b>10</b>
16.1	Data sheet status .....	10
16.2	Definitions .....	10
16.3	Disclaimers .....	10
16.4	Trademarks .....	10
<b>17</b>	<b>Contact information</b> .....	<b>10</b>
<b>18</b>	<b>Contents</b> .....	<b>11</b>

Please be aware that important notices concerning this document and the product(s) described herein, have been included in section 'Legal information'.



© NXP B.V. 2007.

All rights reserved.

For more information, please visit: <http://www.nxp.com>

For sales office addresses, please send an email to: [salesaddresses@nxp.com](mailto:salesaddresses@nxp.com)

Date of release: 20 July 2007

Document identifier: 74HC\_HCT1G86\_4