

NPN SILICON PLANAR EPITAXIAL TRANSISTORS

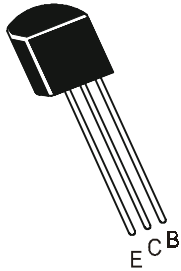

**BC167A, BC167B
BC168A, BC168B, BC168C
BC169B, BC169C**

**TO-92
Plastic Package**

AF Pre and Driver Stages as well as for Universal Application.

ABSOLUTE MAXIMUM RATINGS(Ta=25°C unless specified otherwise)

DESCRIPTION	SYMBOL	BC167	BC168	BC169	UNITS
Collector -Emitter Voltage	V_{CEO}	45	20	20	V
Collector -Emitter Voltage	V_{CES}	50	30	30	V
Emitter -Base Voltage	V_{EBO}	6.0	5	5	V
Collector Current Continuous	I_C	100	100	50	mA
Collector Peak Current	I_{CM}	200	200		mA
Base Current	I_B	50	50	5	mA
Power Dissipation @ Ta=25°C	P_{tot}		300		mW
Storage Junction	T_{stg}		-55 to +150		°C
Junction Temperature	T_j		150		°C
THERMAL RESISTANCE					
Junction to Ambient	$R_{th(j-a)}$		420		K/W

ELECTRICAL CHARACTERISTICS (Ta=25°C Unless Specified Otherwise)

DESCRIPTION	SYMBOL	TEST CONDITION	MIN	TYP	MAX	UNITS
Collector -Emitter Voltage	BC167	BV_{CEO} $I_C=2mA, I_B=0$	45			V
	BC168, 169		20			V
Emitter-Base Voltage	BC167	BV_{EBO} $I_E=1\mu A, I_C=0$	6			V
	BC168, 169		5			V
Collector-Cut off Current	BC167	I_{CES} $V_{CE}=50V, V_{BE}=0$			15	nA
	BC168, 169	$V_{CE}=30V, V_{BE}=0$			15	nA
	BC167	$T_a = 125^\circ C$ $V_{CE}=50V, V_{BE}=0$			4	μA
	BC168, 169	$V_{CE}=30V, V_{BE}=0$			4	μA

NPN SILICON PLANAR EPITAXIAL TRANSISTORS

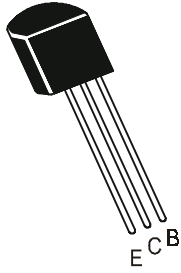

**BC167A, BC167B
BC168A, BC168B, BC168C
BC169B, BC169C**

**TO-92
Plastic Package**

ELECTRICAL CHARACTERISTICS (Ta=25°C Unless Specified Otherwise)

DESCRIPTION		SYMBOL	TEST CONDITION	MIN	TYP	MAX	UNITS	
DC Current Gain	A	h_{FE}	$I_C=0.01mA, V_{CE}=5V$		90			
	B				150			
	C				270			
		A		$I_C=2mA, V_{CE}=5V$	120		220	
		B			180		460	
		C			380		800	
	BC167A, 168A		$I_C=100mA, V_{CE}=5V$		120			
	BC167B, 168B				200			
	BC168C				400			
Collector Emitter Saturation Voltage		$V_{CE(Sat)}$ *	$I_C=10mA, I_B=0.5mA$			0.2	V	
		$V_{CE(Sat)}$ *	$I_C=100mA, I_B=5mA^{**}$			0.6	V	
Base Emitter Saturation Voltage		$V_{BE(Sat)}$ *	$I_C=10mA, I_B=0.5mA$			0.83	V	
		$V_{BE(Sat)}$ *	$I_C=100mA, I_B=5mA^{**}$			1.05	V	
Base Emitter On Voltage		$V_{BE(On)}$	$I_C=2mA, V_{CE}=5V$	0.55		0.7	V	
			$I_C=0.1mA, V_{CE}=5V$		0.55		V	
			$I_C=100mA, V_{CE}=5V^{**}$		0.83		V	

DESCRIPTION		SYMBOL	TEST CONDITION	MIN	TYP	MAX	UNITS
DYNAMIC CHARACTERISTICS							
Transistors Frequency		f_T	$I_C=0.5mA, V_{CE}=3V$		85		MHz
			$I_C=10mA, V_{CE}=5V$	150			MHz
Collector Capacitance		C_{cbo}	$V_{CB}=10V, I_E=0$			4.5	pF
Emitter Capaitance		C_{ebo}	$V_{EB}=0.5V, f=1MHz$		8.0		pF

NPN SILICON PLANAR EPITAXIAL TRANSISTORS

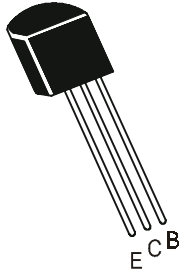

**BC167A, BC167B
BC168A, BC168B, BC168C
BC169B, BC169C**

**TO-92
Plastic Package**

DESCRIPTION		SYMBOL	TEST CONDITION	MIN	TYP	MAX	UNITS
DYNAMIC CHARACTERISTICS							
Noise Figure							
Small Signall Current Gain	BC169	NF	$I_C=0.2mA, V_{CE}=5V$			4.0	dB
	A		$R_g=2W, f=30HZ$ to 15kHz				
Small Signall Current Gain	BC167, 168	NF	$I_C=0.2mA, V_{CE}=5V$			10	
	BC169		$R_g=2W, f=1kHz,$ $f=200Hz$			4	dB
	A	h_{11e}	$I_C=2mA, V_{CE}=5V,$ $f=1kHz$	1.6		4.5	kW
	B			3.2		8.5	kW
	C			6.0		16	kW
	A	h_{12e}			1.5		10^{-4}
	B				2.0		
	C				3.0		
	A	h_{21e}		125		260	
	B			240		500	
	C			450		900	
	A	h_{22e}				30	μ MHO
	B					60	μ MHO
	C					110	μ MHO

**** Measuring Values not for BC169**

*** The transistor is overdriven to such an extent that the static forward current transfer ratio has decreased to $h_{FE} = 20$**

**BC167A, BC167B
BC168A, BC168B, BC168C
BC169B, BC169C**

**TO-92
Plastic Package**

TO-92 Plastic Package

TO-92 Transistors on Tape and Ammo Pack

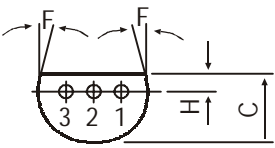
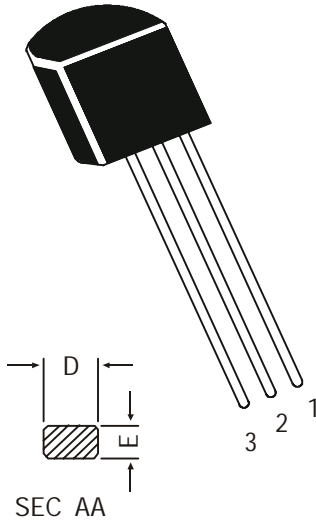
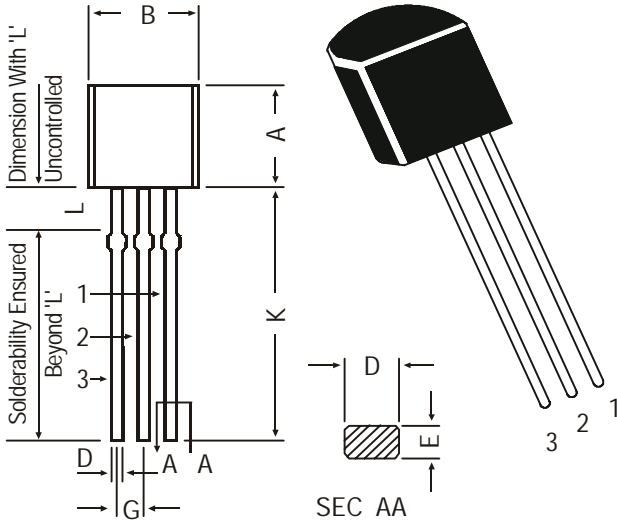

PIN CONFIGURATION
1. BASE
2. COLLECTOR
3. EMITTER

DIM	MIN.	MAX.
A	4.32	5.33
B	4.45	5.20
C	3.18	4.19
D	0.41	0.55
E	0.35	0.50
F	5 DEG	
G	1.14	1.40
H	1.14	1.53
K	12.70	—
L	1.982	2.082

All dimensions in mm.

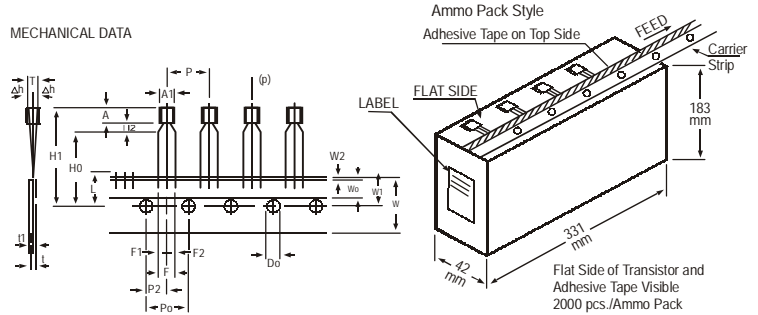

All dimensions in mm unless specified otherwise

ITEM	SYMBOL	SPECIFICATION				REMARKS
		MIN.	NOM.	MAX.	TOL.	
BODY WIDTH	A1	4.0		4.8		
BODY HEIGHT	A	4.8		5.2		
BODY THICKNESS	T	3.9		4.2		
PITCH OF COMPONENT	P		12.7		±1	
FEED HOLE PITCH	Po		12.7		±0.3	
FEED HOLE CENTRE TO COMPONENT CENTRE	P2		6.35		±0.4	CUMULATIVE PITCH ERROR 1.0 mm/20 PITCH TO BE MEASURED AT BOTTOM OF CLINCH
DISTANCE BETWEEN OUTER LEADS	F		5.08		+0.6	
COMPONENT ALIGNMENT	Δh		0	1	-0.2	AT TOP OF BODY
TAPE WIDTH	W		18		±0.5	
HOLD-DOWN TAPE WIDTH	W0		6		±0.2	
HOLE POSITION	W1		9		+0.7 -0.5	
HOLD-DOWN TAPE POSITION	W2		0.5		±0.2	
LEAD WIRE CLINCH HEIGHT	Ho		16		±0.5	
COMPONENT HEIGHT	H1			23.25		
LENGTH OF SNIPPED LEADS	L			11.0		
FEED HOLE DIAMETER	Do		4		±0.2	
TOTAL TAPE THICKNESS	t			1.2		t1 0.3 - 0.6
LEAD - TO - LEAD DISTANCE F1,	F2		2.54		+0.4 -0.1	
CLINCH HEIGHT	H2			3		
PULL - OUT FORCE	(P)		6N			

NOTES

1. MAXIMUM ALIGNMENT DEVIATION BETWEEN LEADS NOT TO BE GREATER THAN 0.2 mm.
2. MAXIMUM NON-CUMULATIVE VARIATION BETWEEN TAPE FEED HOLES SHALL NOT EXCEED 1 mm IN 20 PITCHES.
3. HOLDDOWN TAPE NOT TO EXCEED BEYOND THE EDGE(S) OF CARRIER TAPE AND THERE SHALL BE NO EXPOSURE OF ADHESIVE.
4. NO MORE THAN 3 CONSECUTIVE MISSING COMPONENTS ARE PERMITTED.
5. A TAPE TRAILER, HAVING AT LEAST THREE FEED HOLES ARE REQUIRED AFTER THE LAST COMPONENT.
6. SPLICES SHALL NOT INTERFERE WITH THE SPROCKET FEED HOLES.

Packing Detail

PACKAGE	STANDARD PACK		INNER CARTON BOX		OUTER CARTON BOX		
	Details	Net Weight/Qty	Size	Qty	Size	Qty	Gr Wt
TO-92 Bulk	1K/polybag	200 gm/1K pcs	3" x 7.5" x 7.5"	5K	17" x 15" x 13.5"	80K	23 kgs
TO-92 T&A	2K/ammo box	645 gm/2K pcs	12.5" x 8" x 1.8"	2K	17" x 15" x 13.5"	32K	12.5 kgs

Disclaimer

The product information and the selection guides facilitate selection of the CDIL's Discrete Semiconductor Device(s) best suited for application in your product(s) as per your requirement. It is recommended that you completely review our Data Sheet(s) so as to confirm that the Device(s) meet functionality parameters for your application. The information furnished in the Data Sheet and on the CDIL Web Site/CD is believed to be accurate and reliable. CDIL however, does not assume responsibility for inaccuracies or incomplete information. Furthermore, CDIL does not assume liability whatsoever, arising out of the application or use of any CDIL product; neither does it convey any license under its patent rights nor rights of others. These products are not designed for use in life saving/support appliances or systems. CDIL customers selling these products (either as individual Discrete Semiconductor Devices or incorporated in their end products), in any life saving/support appliances or systems or applications do so at their own risk and CDIL will not be responsible for any damages resulting from such sale(s).

CDIL strives for continuous improvement and reserves the right to change the specifications of its products without prior notice.



CDIL is a registered Trademark of

Continental Device India Limited

C-120 Naraina Industrial Area, New Delhi 110 028, India.

Telephone + 91-11-579 6150 Fax + 91-11-579 9569, 579 5290

e-mail sales@cdil.com www.cdil.com