



Micro Commercial Components
 21201 Itasca Street Chatsworth
 CA 91311
 Phone: (818) 701-4933
 Fax: (818) 701-4939

BZX84C2V4 THRU BZX84C39

Silicon

410 mWatt

Zener Diodes

Features

- Planar Die construction
- 410mW Power Dissipation
- Zener Voltages from 2.4V - 39V
- Ideally Suited for Automated Assembly Processes

Mechanical Data

- Case: SOT-23, Plastic
- Terminals: solderable per MIL-STD-202, Methode 208
- Weight: 0.008 grams (approx.)

Maximum Ratings @ 25°C Unless Otherwise Specified

Zener Current	I_F	100	mA
Maximum Forward Voltage	V_F	1.2	V
Power Dissipation (Note 1)	P_(AV)	410	mWatt
Operation And Storage Temperature	T_J, T_{STG}	-55°C to +150°C	
Peak Forward Surge Current 8.3ms half	I_{FSM}	2.0	A

NOTES:

- A. Mounted on 5.0mm² (.013mm thick) land areas.
 B. Measured on 8.3ms, single half sine-wave or equivalent square wave, duty cycle = 4 pulses per minute maximum.

*Pin Configuration - Top View

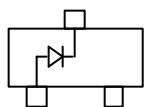

SOT-23

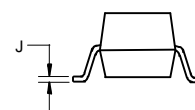
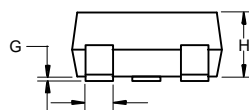
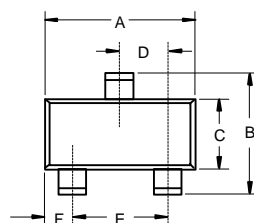

DIM	DIMENSIONS				NOTE
	INCHES		MM		
	MIN	MAX	MIN	MAX	
A	.110	.120	2.80	3.04	
B	.083	.098	2.10	2.64	
C	.047	.055	1.20	1.40	
D	.035	.041	.89	1.03	
E	.070	.081	1.78	2.05	
F	.018	.024	.45	.60	
G	.0005	.0039	.013	.100	
H	.035	.044	.89	1.12	
J	.003	.007	.085	.180	
K	.015	.020	.37	.51	

Suggested Solder Pad Layout

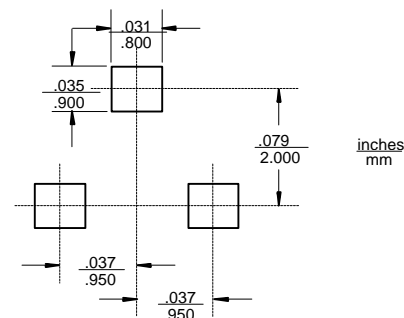

BZX84C2V4 thru BZX84C39

ELECTRICAL CHARACTERISTICS (TA=25 degree C unless otherwise noted) VF=1.2V max, IF=100mA for all types.

Type Number	Marking Code	Nominal Zener Voltage			Max. Zener Impedance				Max.Reverse Leakage Current	
		Vz @ IzT			ZzT @ IzT		Zzk @ Izk		IR @ VR	
		Nom. V	Min. V	Max. V	Ohm	mA	Ohm	mA	uA	V
BZX84C2V4	W1	2.4	2.28	2.52	100	5	600	1	50	1
BZX84C2V7	W2	2.7	2.5	2.9	100	5	600	1	20	1
BZX84C3	W3	3	2.8	3.2	95	5	600	1	10	1
BZX84C3V3	W4	3.3	3.1	3.5	95	5	600	1	5.0	1
BZX84C3V6	W5	3.6	3.4	3.8	90	5	600	1	5.0	1
BZX84C3V9	W6	3.9	3.7	4.1	90	5	600	1	3.0	1
BZX84C4V3	W7	4.3	4	4.6	90	5	600	1	3.0	1
BZX84C4V7	W8	4.7	4.4	5	80	5	500	1	3.0	2
BZX84C5V1	W9	5.1	4.8	5.4	60	5	480	1	2.0	2.0
BZX84C5V6	WA	5.6	5.2	6	40	5	400	1	1.0	2.0
BZX84C6V2	WB	6.2	5.8	6.6	10	5	150	1	3.0	4.0
BZX84C6V8	WC	6.8	6.4	7.2	15	5	80	1	2.0	4.0
BZX84C7V5	WD	7.5	7	7.9	15	5	80	1	1.0	5
BZX84C8V2	WE	8.2	7.7	8.7	15	5	80	1	0.7	5
BZX84C9V1	WF	9.1	8.5	9.6	15	5	100	1	0.5	6
BZX84C10	WG	10	9.4	10.6	20	5	150	1	0.2	7.0
BZX84C11	WH	11	10.4	11.6	20	5	150	1	0.1	8.0
BZX84C12	WI	12	11.4	12.7	25	5	150	1	0.1	8.0
BZX84C13	WK	13	12.4	14.1	30	5	170	1	0.1	8.0
BZX84C15	WL	15	13.8	15.6	30	5	200	1	0.1	10.5
BZX84C16	WM	16	15.3	17.1	40	5	200	1	0.1	11.2
BZX84C18	WN	18	16.8	19.1	45	5	225	1	0.1	12.6
BZX84C20	WO	20	18.8	21.2	55	5	225	1	0.1	14.0
BZX84C22	WP	22	20.8	23.3	55	5	250	1	0.1	15.4
BZX84C24	WR	24	22.8	25.6	70	5	250	1	0.1	16.8
BZX84C27	WS	27	25.1	28.9	80	5	300	1	0.1	18.9
BZX84C30	WT	30	28	32	80	5	300	1	0.1	21.0
BZX84C33	WU	33	31	35	80	5	325	1	0.1	23.1
BZX84C36	WW	36	34	38	90	5	350	1	0.1	25.2
BZX84C39	WX	39	37	41	130	5	350	1	0.1	27.3

NOTE:

1. Tolerance and Type Number Designation. The type numbers listed have a standard tolerance on the nominal zener voltage of $\pm 5\%$.
2. Specials Available Include:
 - A. Nominal zener voltages between the voltages shown and tighter voltage tolerances.
 - B. Matched sets.
3. Zener Voltage (Vz) Measurement. Guarantees the zener voltage when measured at 90 seconds while maintaining the lead temperature (TL) at 30°C, from the diode body.
4. Zener Impedance (Zz) Derivation. The zener impedance is derived from the 60 cycle ac voltage, which results when an AC current having an rms value equal to 10% of the dc zener current (IzT or IzK) is superimposed on IzT or IzK.
5. Surge Current (IR) Non-Repetitive. The rating listed in the electrical characteristics table is maximum peak, non-repetitive, reverse surge current of 1/2 square wave or equivalent sine wave pulse of 1/120 second duration superimposed on the test current, IzT, per JEDEC registration; however, actual device capability is as described in Figure 5.

BZX84C2V4 thru BZX84C39

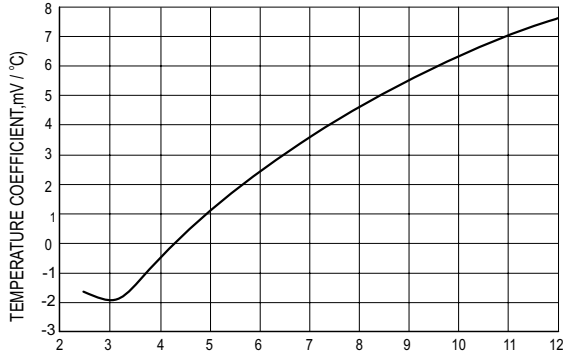
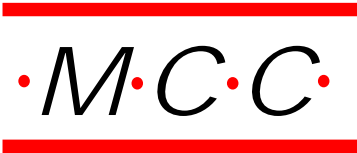

NOMINAL ZENER VOLTAGE, Volts

TYPICAL REVERSE CURRENT

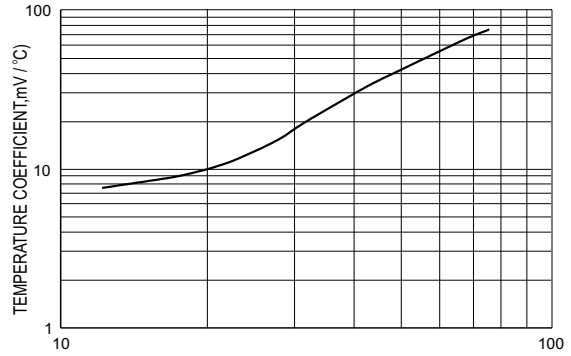

NOMINAL ZENER VOLTAGE, Volts

STEADY STATE POWER DERATING

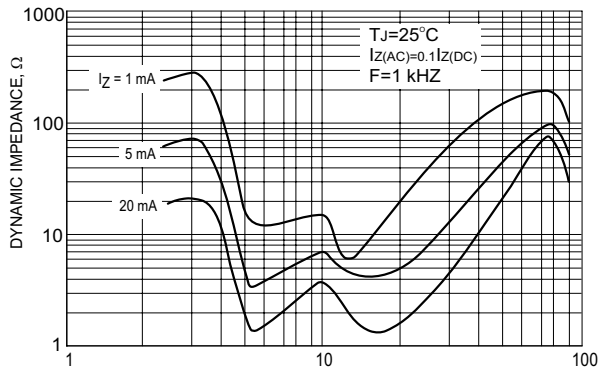

NORMAL ZENER VOLTAGE, Volts

EFFECT OF ZENER VOLTAGE ON ZENER IMPEDANCE

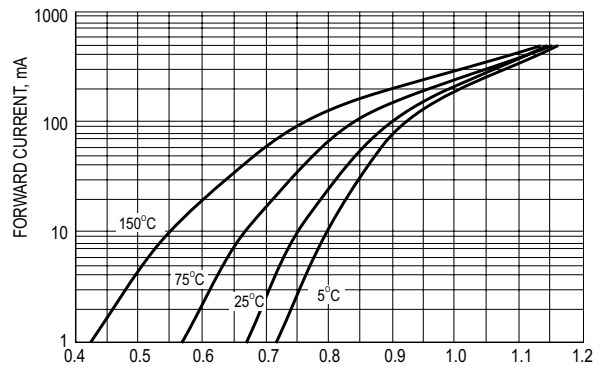

FORWARD VOLTAGE, Volts

TYPICAL FORWARD VOLTAGE

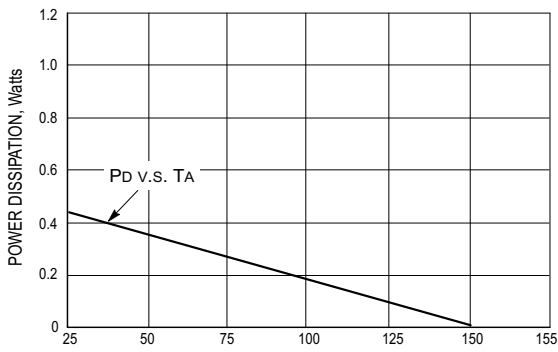

TEMPERATURE (°C)

STEADY STATE POWER DERATING

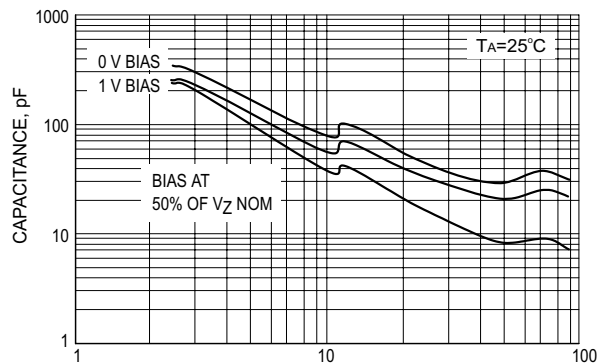

NOMINAL ZENER VOLTAGE, Volts

TYPICAL CAPACITANCE

BZX84C2V4 thru BZX84C39

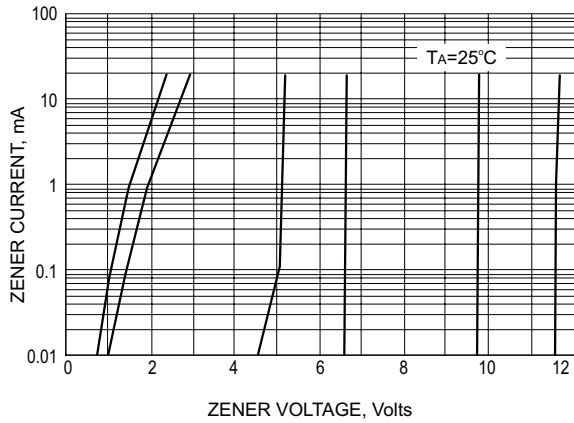

ZENER VOLTAGE V.S. ZENER CURRENT

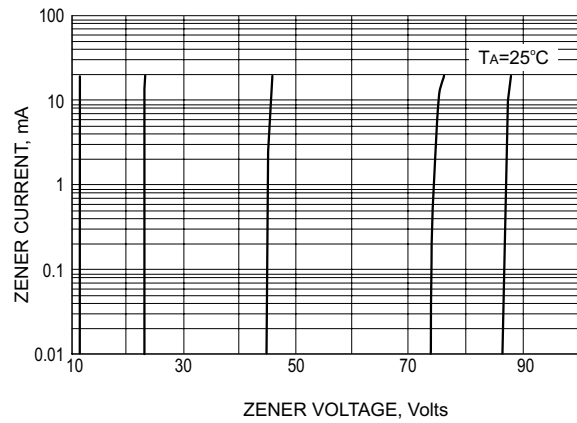

ZENER VOLTAGE V.S. ZENER CURRENT

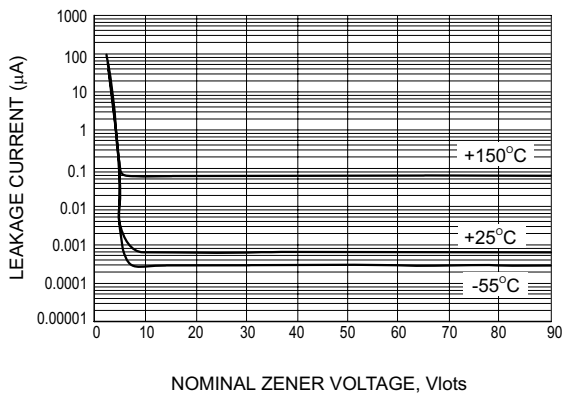

TYPICAL LEAKGE CURRENT