

Balanced modulator/demodulator

MC1496/MC1596

DESCRIPTION

The MC1496 is a monolithic double-balanced modulator/demodulator designed for use where the output voltage is a product of an input voltage (signal) and a switched function (carrier). The MC1596 will operate over the full military temperature range of -55 to +125°C. The MC1496 is intended for applications within the range of 0 to +70°C.

FEATURES

- Excellent carrier suppression
65dB typ @ 0.5MHz
50dB typ @ 10MHz
- Adjustable gain and signal handling
- Balanced inputs and outputs
- High common-mode rejection—85dB typ

APPLICATIONS

- Suppressed carrier and amplitude modulation
- Synchronous detection
- FM detection
- Phase detection
- Sampling
- Single sideband
- Frequency doubling

PIN CONFIGURATION

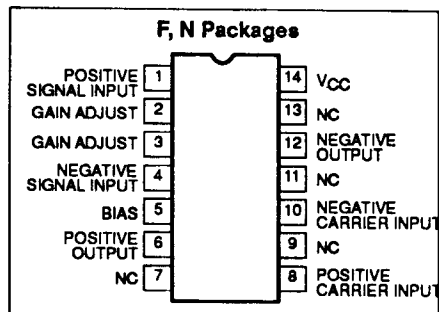

ORDERING INFORMATION

DESCRIPTION	TEMPERATURE RANGE	ORDER CODE	DWG #
14-Pin Ceramic Dual In-Line Package Cerdip)	0 to +70°C	MC1496F	0581B
14-Pin Plastic Dual In-Line Package (DIP)	0 to +70°C	MC1496N	0405B
14-Pin Ceramic Dual In-Line Package Cerdip)	-55 to +125°C	MC1596F	0581B
14-Pin Plastic Dual In-Line Package (DIP)	-55 to +125°C	MC1596N	0405B

ABSOLUTE MAXIMUM RATINGS

SYMBOL	PARAMETER	RATING	UNIT
	Applied voltage	30	V
V_8-V_{10}	Differential input signal	± 5.0	V
V_4-V_1	Differential input signal	$(5 \pm 1.5 R_0)$	V
V_2-V_1 , V_3-V_4	Input signal	5.0	V
I_5	Bias current	10	mA
P_D	Maximum power dissipation, $T_A=25^\circ\text{C}$ (still-air) ¹	F package 1190 N package 1420	mW mW
T_A	Operating temperature range	MC1496 0 to +70 MC1596 -55 to +125	°C °C
T_{STG}	Storage temperature range	-65 to +150	°C

NOTES:

1. Derate above 25°C, at the following rates:
F package at 9.5mW/°C
N package at 11.4mW/°C

Balanced modulator/demodulator

MC1496/MC1596

EQUIVALENT SCHEMATIC

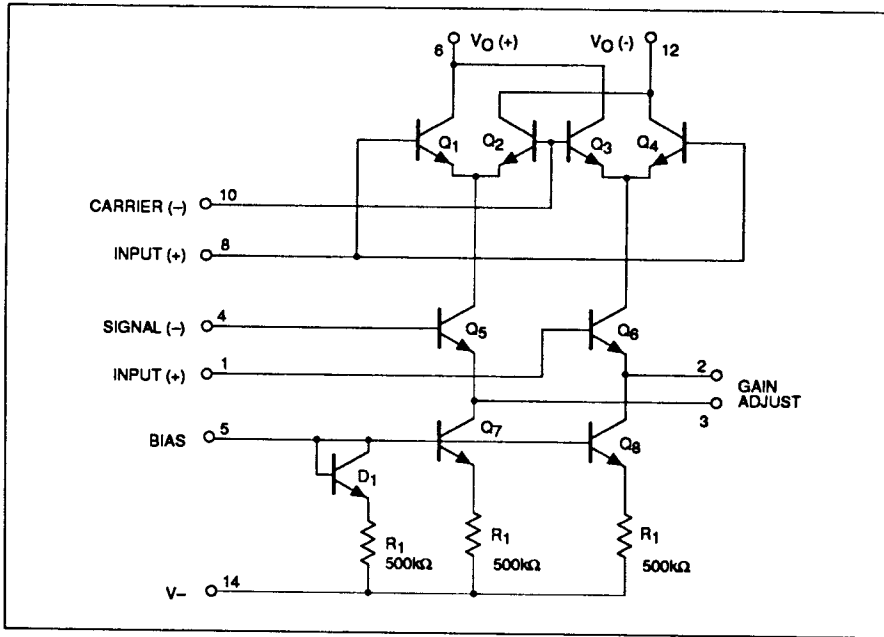

DC ELECTRICAL CHARACTERISTICS

$V_{CC}=+12V_{DC}$; $V_{CC}=-8.0V_{DC}$; $I_S=1.0mA_{DC}$; $R_L=3.9k\Omega$; $R_E=1.0k\Omega$; $T_A=25^\circ C$, unless otherwise specified.

SYMBOL	PARAMETER	TEST CONDITIONS	MC1596			MC1496			UNIT
			Min	Typ	Max	Min	Typ	Max	
R_{IP} C_{IP}	Single-ended input impedance Parallel input resistance Parallel input capacitance	Signal port, $f=5.0MHz$		200 2.0			200 2.0		$k\Omega$ pF
R_{OP} C_{OP}	Single-ended output impedance Parallel output resistance Parallel output capacitance	$f=10MHz$		40 5.0			40 5.0		$k\Omega$ pF
I_{BS} I_{BC}	Input bias current $I_{BS}=$ $I_{BC}=$			12 12	25 25		12 12	30 30	μA μA
I_{IOS} I_{IOC}	Input offset current $I_{IOS}=I_1-I_4$ $I_{IOC}=I_8-I_{10}$			0.7 0.7	5.0 5.0		0.7 0.7	7.0 7.0	μA μA
T_{CI0} I_{OO}	Average temperature coefficient of input offset current Output offset current I_8-I_{12}			2.0 14			2.0 15		$nA/^\circ C$ μA
T_{C00} V_O	Average temperature coefficient of output offset current Common-mode quiescent output voltage (Pin 6 or Pin 12)			90 8.0			90 8.0		$nA/^\circ C$ V_{DC}
I_{D+} I_{D-}	Power supply current I_6+I_{12} I_{14}			2.0 3.0	3.0 4.0		2.0 3.0	4.0 5.0	mA_{DC}
P_D	DC power dissipation			33			33		mW

Balanced modulator/demodulator

MC1496/MC1596

AC ELECTRICAL CHARACTERISTICS

$V_{CC}=+12V_{DC}$; $V_{CC}=-9.0V_{DC}$; $I_S=1.0mA_{DC}$; $R_L=3.9k\Omega$; $R_E=1.0k\Omega$; $T_A=+25^\circ C$ unless otherwise specified.

SYMBOL	PARAMETER	TEST CONDITIONS	MC1596			MC1496			UNIT	
			Min	Typ	Max	Min	Typ	Max		
V_{CFT}	Carrier feedthrough	$V_C=60mV_{RMS}$ sinewave and offset adjusted to zero $f_C=1.0kHz$ $f_C=10MHz$ $V_C=300mV_{P-P}$ squarewave: Offset adjusted to zero $f_C=1.0kHz$ Offset not adjusted $f_C=1.0kHz$		40			40		μV_{RMS}	
				140			140			
				0.04	0.2		0.04	0.4		mV_{RMS}
				20	100		20	200		
V_{CS}	Carrier suppressions	$f_S=10kHz$, $300mV_{RMS}$ sinewave $f_C=500kHz$, $60mV_{RMS}$ sinewave $f_C=10MHz$, $60mV_{RMS}$ sinewave	50	65 50		40	65 50		dB	
BW_{3dB}	Transadmittance bandwidth (Magnitude) ($R_L=50\Omega$)	Carrier input port, $V_C=60mV_{RMS}$ sinewave $f_S=1.0kHz$, $300mV_{RMS}$ sinewave		300			300		MHz	
		Signal input port, $V_S=300mV_{RMS}$ sinewave $ V_C =0.5V_{DC}$		80			80		MHz	
A_{VS}	Signal gain	$V_S=100mV_{RMS}$; $f=1.0kHz$ $ V_C =0.5V_{DC}$	2.5	3.5		2.5	3.5		V/V	
CMV A_{CM}	Common-mode input swing Common-mode gain	Signal port, $f_S=1.0kHz$ Signal port, $f_S=1.0kHz$ $ V_C =0.5V_{DC}$		5.0 -85			5.0 -85		V_{P-P} dB	
DV_{OUT}	Differential output voltage swing capability			8.0			8.0		V_{P-P}	

Balanced modulator/demodulator

MC1496/MC1596

TEST CIRCUITS

