

GL514/GL513F

TO-18 Type Infrared Emitting Diode

■ Features

- Output : **GL514** Φ_e MIN. 3.31mW at
 $I_F = 100\text{mA}$
GL513F Φ_e MIN. 1.44mW at
 $I_F = 100\text{mA}$
- Beam angle : **GL514** $\Delta\theta$: TYP. $\pm 7^\circ$
GL513F $\Delta\theta$: TYP. $\pm 50^\circ$
- To- 18 type standard package
- High reliability, long operation life

■ Applications

- Optoelectronic switches
- Smoke detectors
- Infrared applied systems

■ Absolute Maximum Ratings

($T_a = 25^\circ\text{C}$)

Parameter	Symbol	Rating	Unit
Power dissipation	P	250	mW
Forward current	I_F	150	mA
*1 Peak forward current	I_{FM}	2	A
Reverse voltage	V_R	6	V
Operating temperature	T_{opr}	- 40 to + 125	$^\circ\text{C}$
Storage temperature	T_{stg}	- 55 to + 125	$^\circ\text{C}$
*2 Soldering temperature	T_{sol}	260	$^\circ\text{C}$

*1 Pulse width $\leq 200\ \mu\text{s}$

Duty ratio = 0.01

*2 For 10 seconds at the position of 1.3mm from the bottom face of can package.

■ Electro-optical Characteristics

($T_a = 25^\circ\text{C}$)

Parameter	Symbol	Conditions	MIN.	TYP.	MAX.	Unit
Forward voltage	V_F	$I_F = 100\text{mA}$	-	1.35	1.6	V
Peak forward voltage	V_{FM}	$I_{FM} = 1.5\text{A}$	-	2.75	4.0	V
Reverse current	I_R	$V_R = 5\text{V}$	-	-	100	μA
Terminal capacitance	C_t	$V = 0, f = 1\text{MHz}$	-	70	-	pF
*3 Radiant flux	GL514	$I_F = 100\text{mA}$	3.31	5.35	10.0	mW
	GL513F		1.44	2.88	-	mW
Peak emission wavelength	λ_p	$I_F = 100\text{mA}$	-	950	-	nm
Half intensity wavelength	$\Delta\lambda$	$I_F = 100\text{mA}$	-	45	-	nm

■ Outline Dimensions

(Unit : mm)

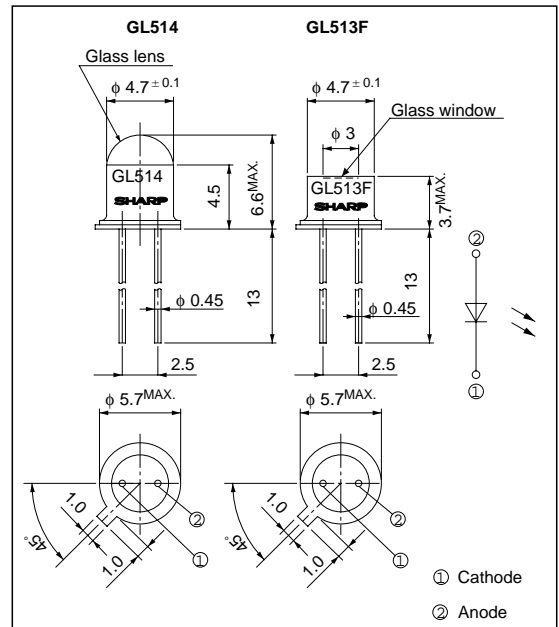

***3 Classification Table of Radiant Flux**

Model No.	Rank Mark	Φ_e (mW)
GL514A	A	5.35 to 10.0
GL514	-	3.31 to 10.0

at $I_F = 100\text{mA}$, $T_a = 25^\circ\text{C}$

Fig. 1 Forward Current vs. Ambient Temperature

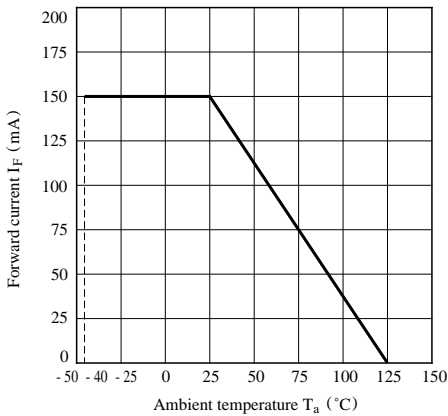

Fig. 2 Peak Forward Current vs. Duty Ratio

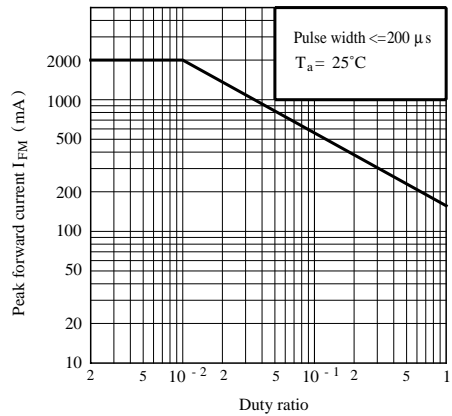

Fig. 3 Spectral Distribution

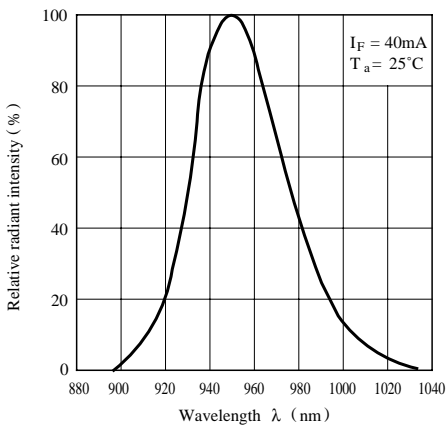

Fig. 4 Peak Emission Wavelength vs. Ambient Temperature

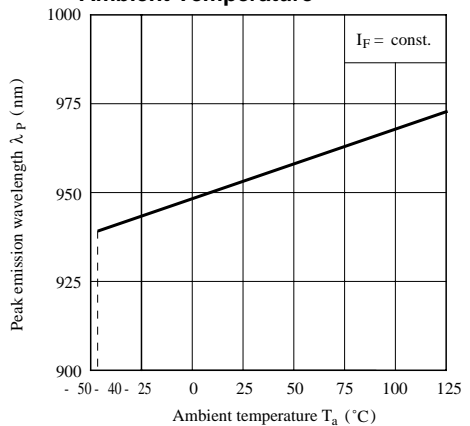

Fig. 5 Forward Current vs. Forward Voltage

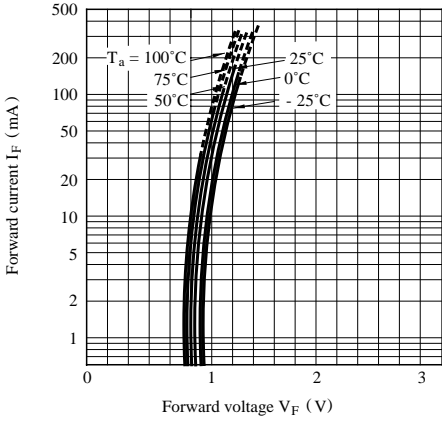

Fig. 6 Relative Radiant Flux vs. Ambient Temperature

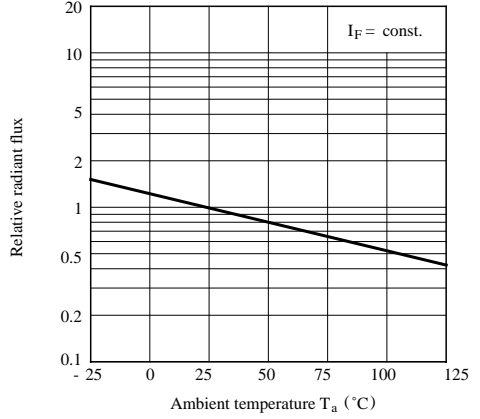

Fig. 7 Radiant Flux vs. Forward Current (GL514)

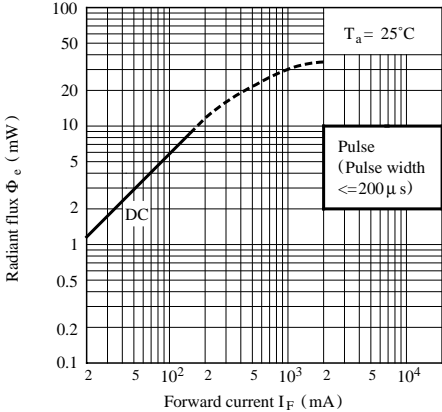

Fig. 8 Radiant Flux vs. Forward Current (GL513F)

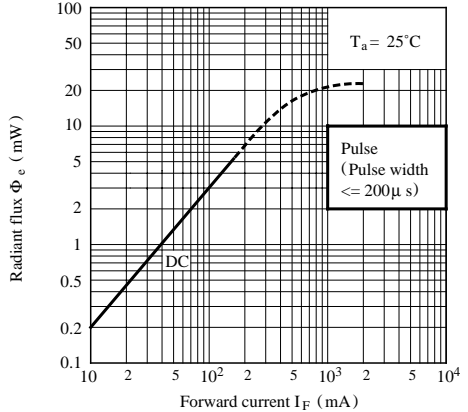

Fig. 9 Relative Radiant Intensity vs. Distance (GL514)

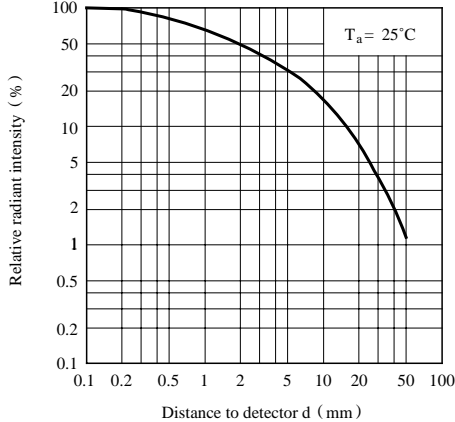

Fig. 10 Relative Radiant Intensity vs. Distance (GL513F)

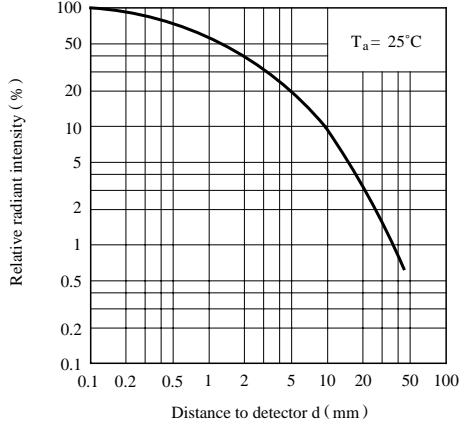
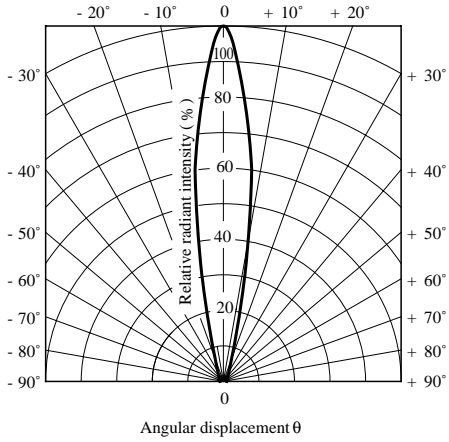
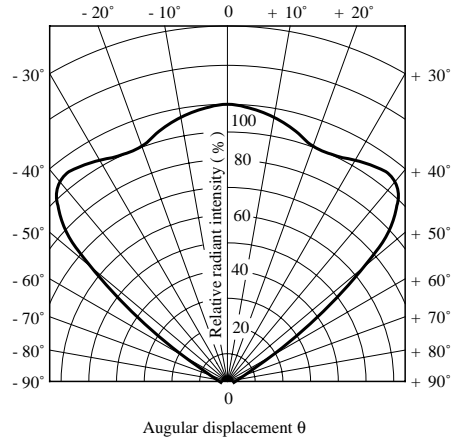

Fig.11 Radiation Diagram (GL514) $(T_a = 25^\circ\text{C})$ **Fig.12 Radiation Diagram (GL513F)** $(T_a = 25^\circ\text{C})$ 

● Please refer to the chapter “Precautions for Use.”