

4 TERMINAL LOW DROP VOLTAGE REGULATOR

The KIA78R×× Series are Low Drop Voltage Regulator suitable for various electronic equipments. It provides constant voltage power source with TO-220 4 terminal lead full molded PKG. The Regulator has multi function such as over current protection, overheat protection and ON/OFF control.

FEATURES

- 1.0A Output Low Drop Voltage Regulator.
- Built in ON/OFF Control Terminal.
- Built in Over Current Protection, Over Heat Protection Function.

LINE UP

ITEM	OUTPUT VOLTAGE (Typ.)	UNIT
KIA78R05API	5	V
KIA78R06API	6	
KIA78R08API	8	
KIA78R09API	9	
KIA78R10API	10	
KIA78R12API	12	
KIA78R15API	15	

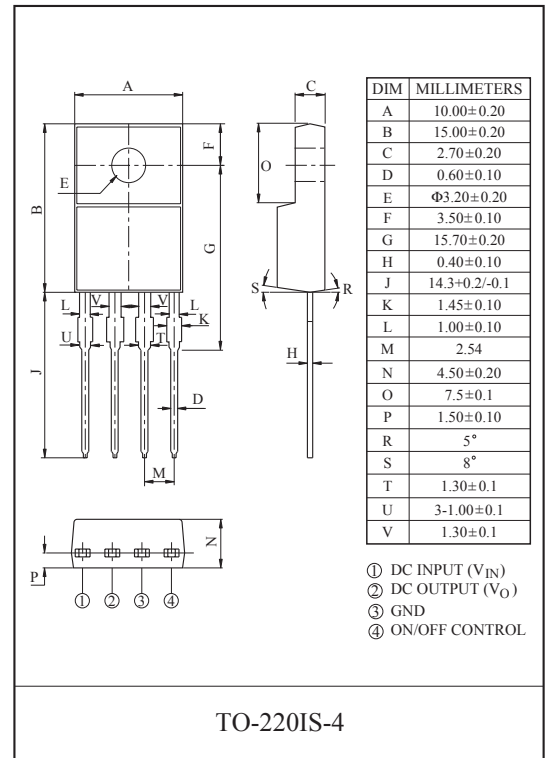

MAXIMUM RATINGS (Ta=25°C)

CHARACTERISTIC	SYMBOL	RATING	UNIT	Remark
Input Voltage	V _{IN}	35	V	-
ON/OFF Control Voltage	V _C	35	V	-
Output Current	I _{OUT}	1	A	-
Power Dissipation 1	P _{D1}	1.5	W	No heatsink
Power Dissipation 2	P _{D2}	15	W	with heatsink
Junction Temperature	T _j	125	°C	-
Operating Temperature	T _{opr}	-20~80	°C	-
Storage Temperature	T _{stg}	-30~125	°C	-
Soldering Temperature (10sec)	T _{sol}	260	°C	-

KIA78R05API~KIA78R15API

ELECTRICAL CHARACTERISTICS

(Unless otherwise specified, $I_{OUT}=0.5A$, $V_{IN}=18V$, $T_a=25^{\circ}C$, Note1.)

CHARACTERISTIC		SYMBOL	CONDITIONS	MIN.	TYP.	MAX.	UNIT
Output Voltage	KIA78R05	V_{OUT}	-	4.88	5.0	5.12	V
	KIA78R06		-	5.85	6.0	6.15	
	KIA78R08		-	7.80	8.0	8.2	
	KIA78R09		-	8.78	9.0	9.22	
	KIA78R10		-	9.75	10.0	10.25	
	KIA78R12		-	11.70	12.0	12.30	
	KIA78R15		-	14.70	15.0	15.30	
Load Regulation		Reg Load	$I_O=5mA \sim 1A$	-	0.1	2.0	%
Line Regulation		Reg Line	(Note2)	-	0.5	2.5	%
Ripple Rejection		$R \cdot R$	-	45	55	-	dB
Drop Out Voltage		V_D	(Note3)	-	-	0.5	V
Output ON state for control Voltage		$V_{C(ON)}$	-	2.0	-	-	V
Output ON state for control Current		$I_{C(ON)}$	$V_C=2.7V$	-	-	20	μA
Output OFF state for control Voltage		$V_{C(OFF)}$	-	-	-	0.8	V
Output OFF state for control Current		$I_{C(OFF)}$	$V_C=0.4V$	-	-	-0.4	mA
Quiescent Current		I_Q	$I_O=0$	-	-	10	mA

Note1) V_{IN} of KIA78R05=7V

- " KIA78R06=8V
- " KIA78R08=10V
- " KIA78R09=15V
- " KIA78R10=16V
- " KIA78R12=18V
- " KIA78R15=21V

Note2) V_{IN} of KIA78R05=6 ~ 12V

- " KIA78R06=7 ~ 15V
- " KIA78R08=9 ~ 25V
- " KIA78R09=10 ~ 25V
- " KIA78R10=11 ~ 26V
- " KIA78R12=13 ~ 29V
- " KIA78R15=16 ~ 32V

Note3) At $V_{IN}=0.95V_O$

BLOCK DIAGRAM

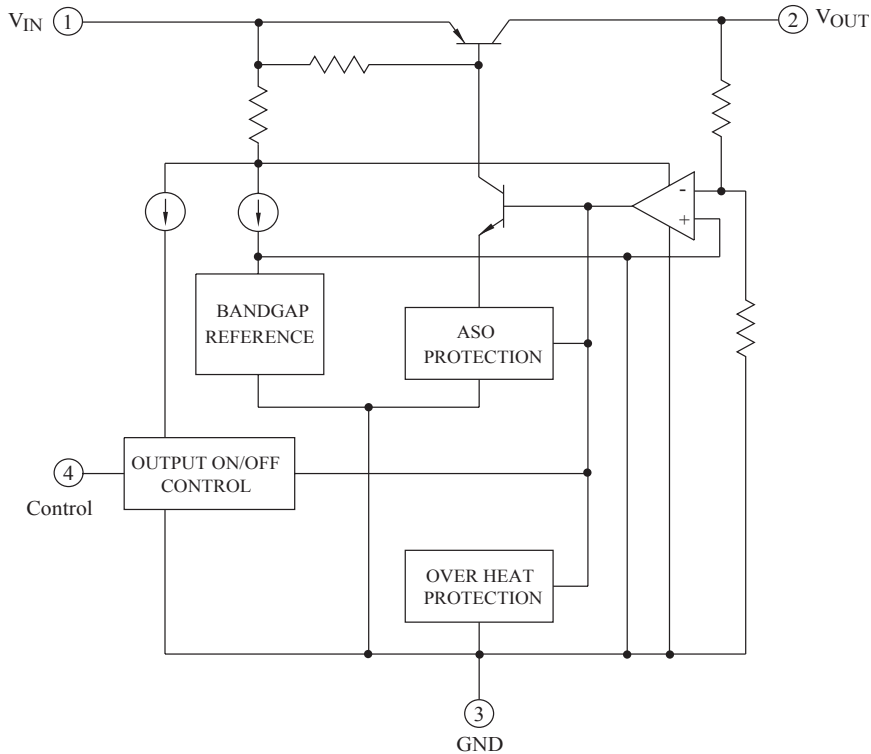

KIA78R05API~KIA78R15API

Fig. 1 Standard Test Circuit

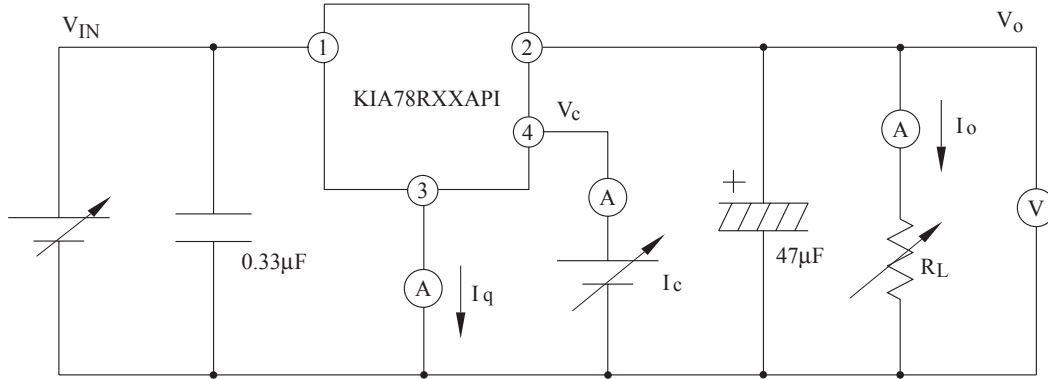

Fig. 1-2 Ripple Rejection Test Circuit

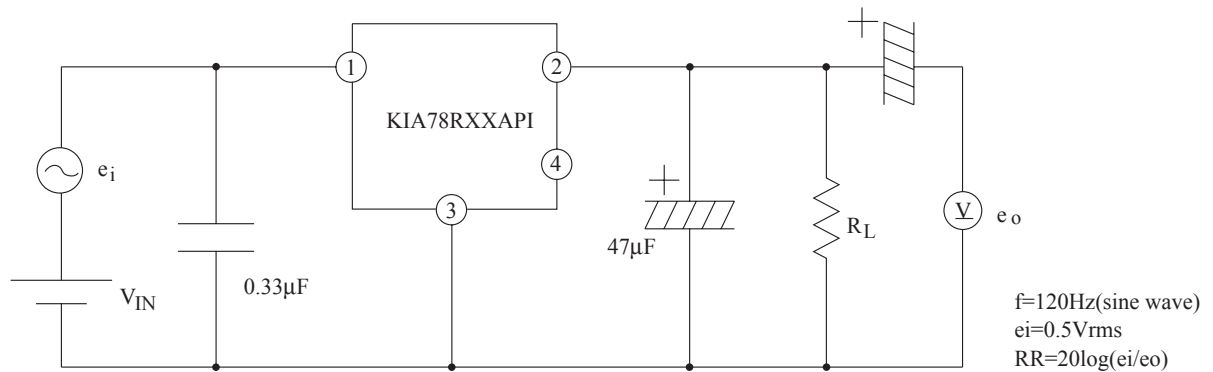
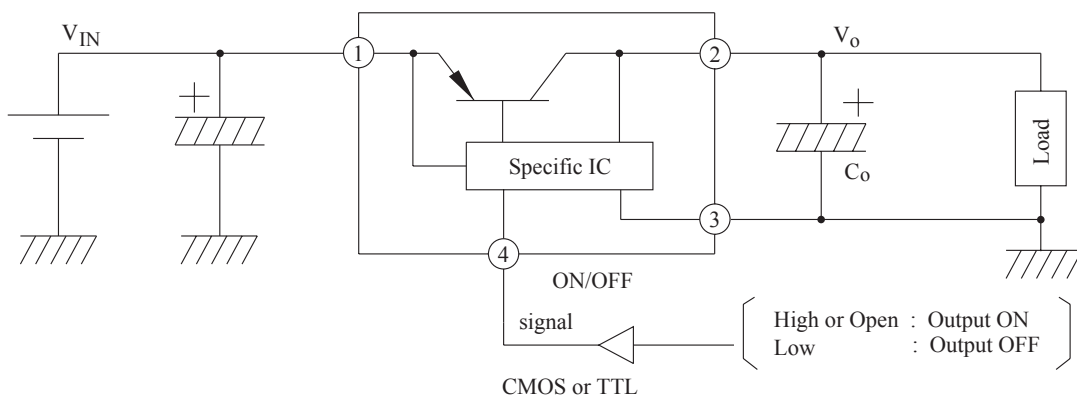
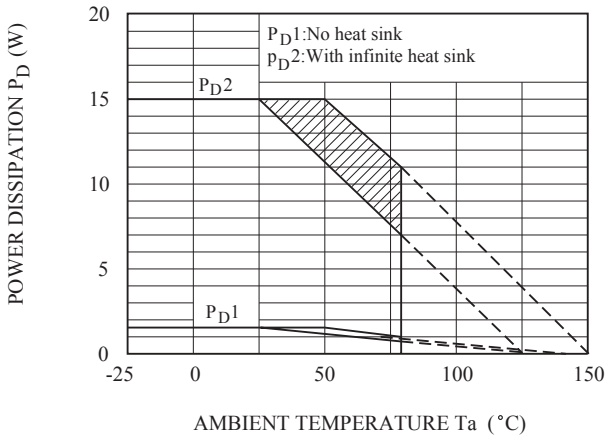

Fig. 2 Application Circuit for Standard



KIA78R05API~KIA78R15API

Fig.3 $T_a - P_D$



Note) Oblique line portion : Overheat protection may operate in this area.

Fig.4 $I_O - V_O$

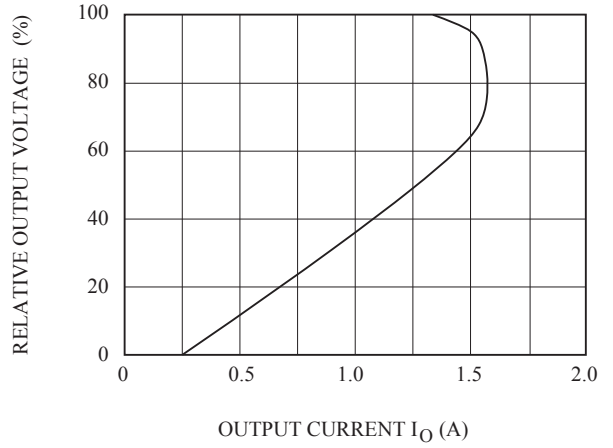

Fig.5-1 $T_j - \Delta V_O$ (KIA78R05)

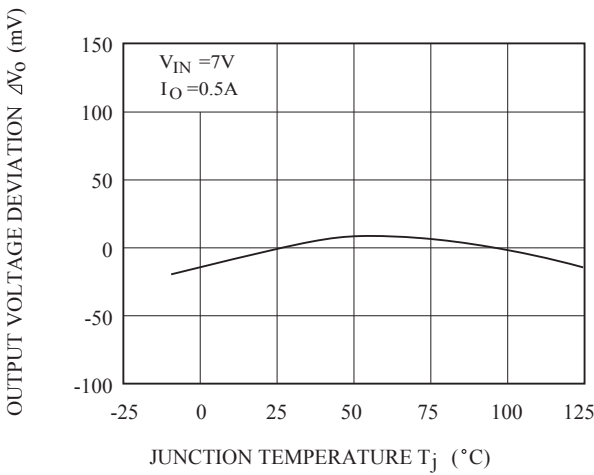

Fig.5-2 $T_j - \Delta V_O$ (KIA78R06)

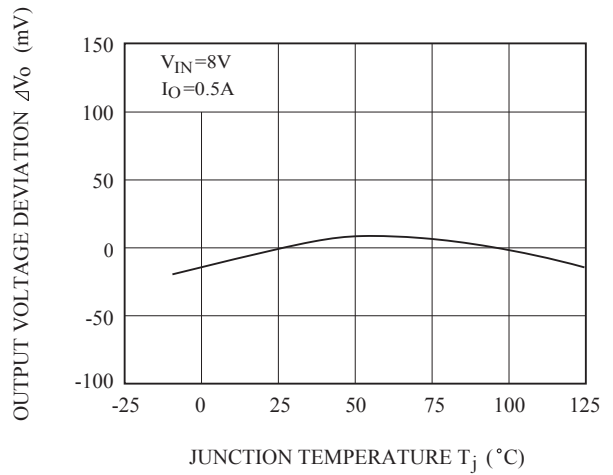

Fig.5-3 $T_j - \Delta V_O$ (KIA78R08)

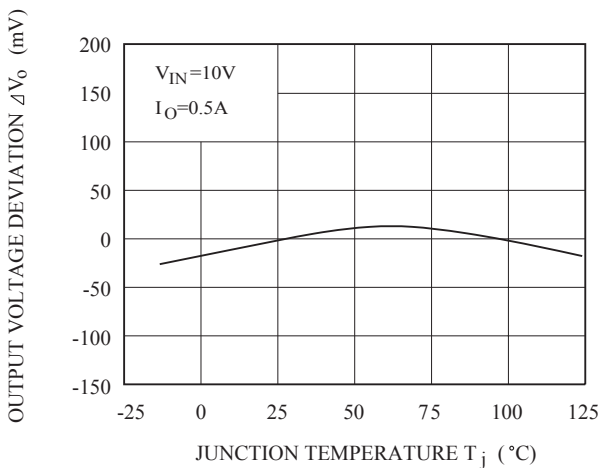
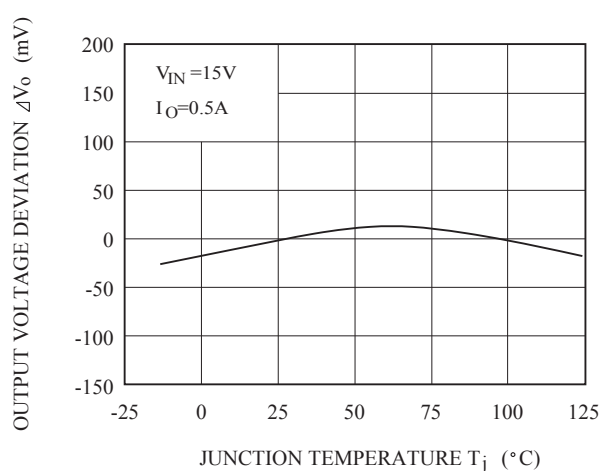

Fig.5-4 $T_j - \Delta V_O$ (KIA78R09)



KIA78R05API~KIA78R15API

Fig.5-5 $T_j - \Delta V_o$ (KIA78R10)

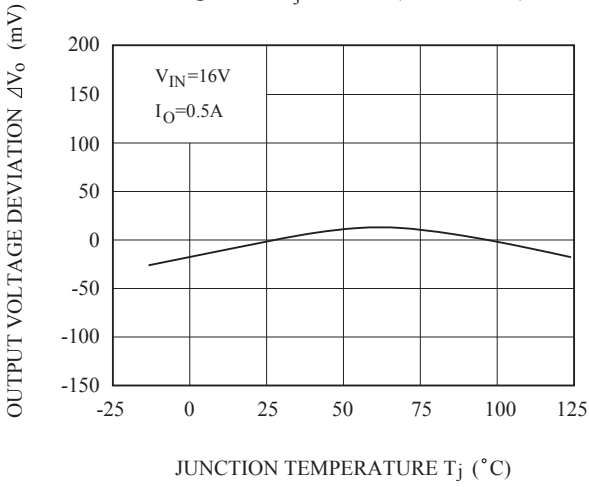

Fig.5-6 $T_j - \Delta V_o$ (KIA78R12)

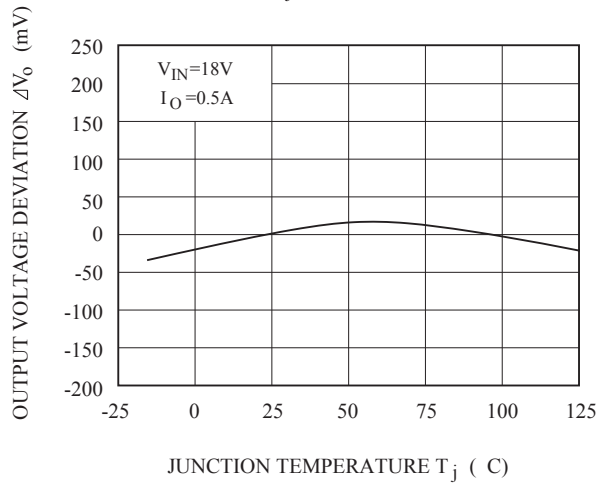

Fig.5-7 $T_j - \Delta V_o$ (KIA78R15)

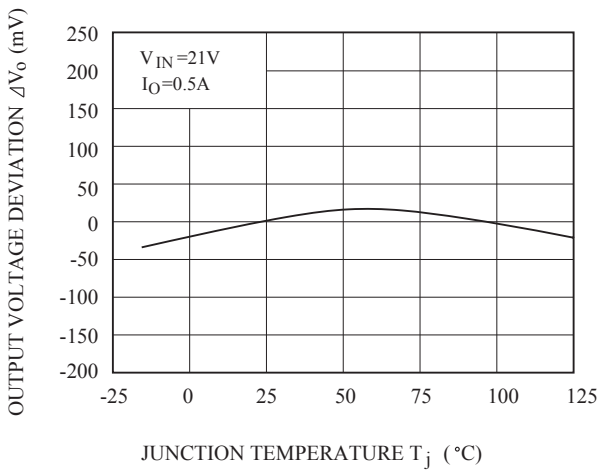

Fig.6-1 $V_{IN} - V_o$ (KIA78R05)

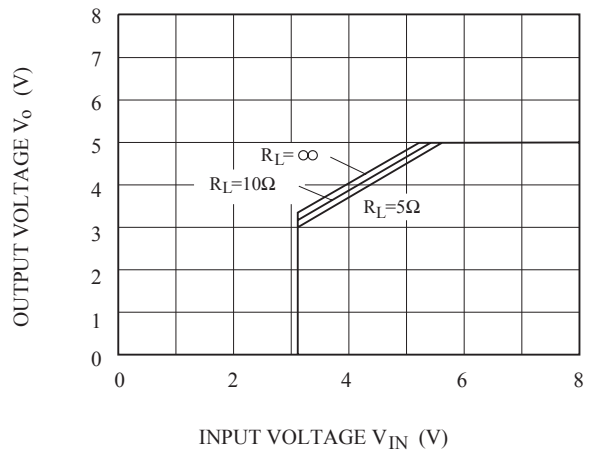

Fig.6-2 $V_{IN} - V_o$ (KIA78R06)

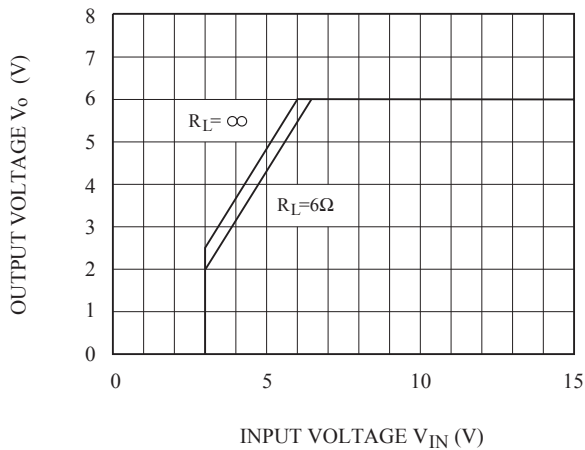
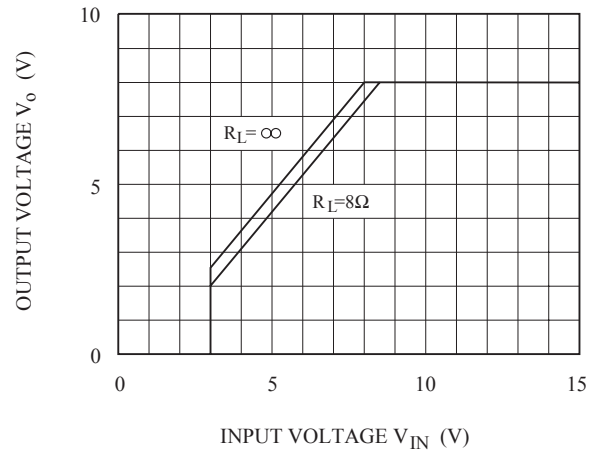

Fig.6-3 $V_{IN} - V_o$ (KIA78R08)



KIA78R05API~KIA78R15API

Fig.6-4 $V_{IN} - V_o$ (KIA78R09)

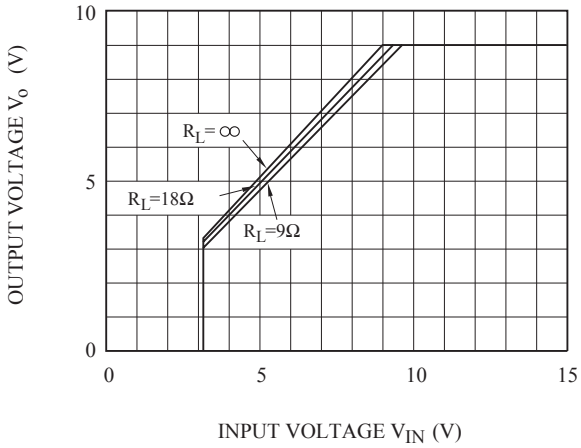

Fig.6-5 $V_{IN} - V_o$ (KIA78R10)

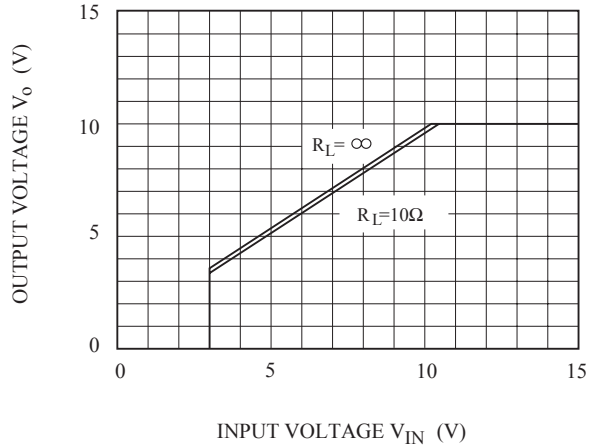

Fig.6-6 $V_{IN} - V_o$ (KIA78R12)

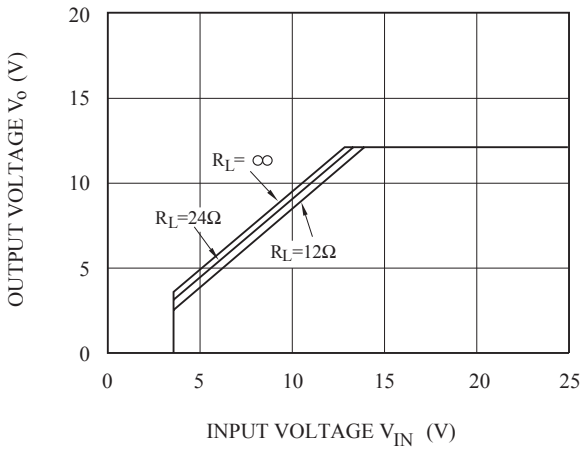

Fig.6-7 $V_{IN} - V_o$ (KIA78R15)

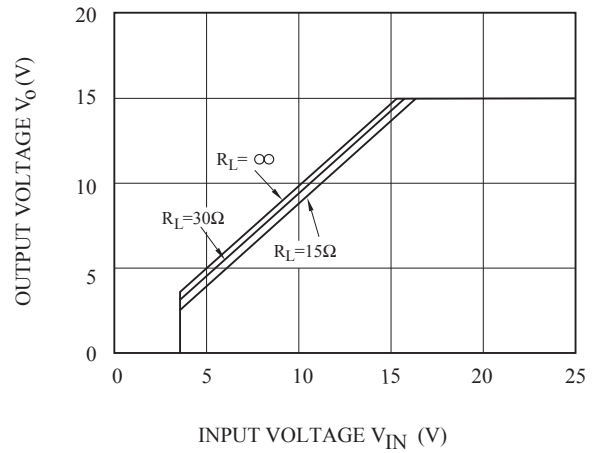

Fig.7-1 $V_{IN} - I_{BIAS}$ (KIA78R05)

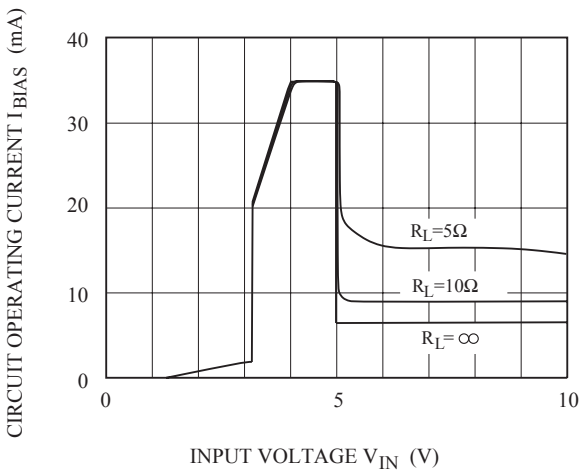
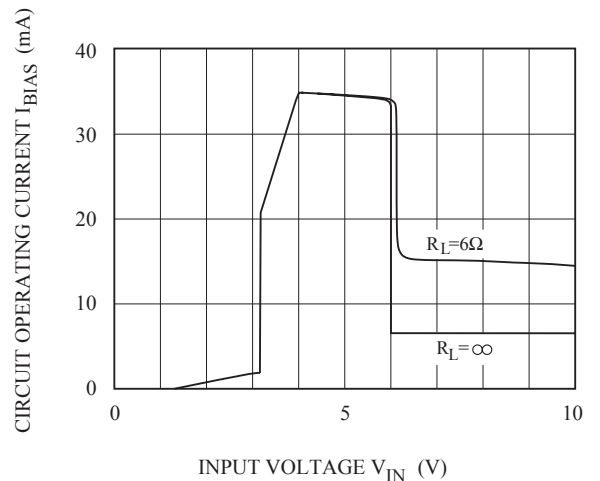

Fig.7-2 $V_{IN} - I_{BIAS}$ (KIA78R06)



KIA78R05API~KIA78R15API

Fig.7-3 $V_{IN} - I_{BIAS}$ (KIA78R08)

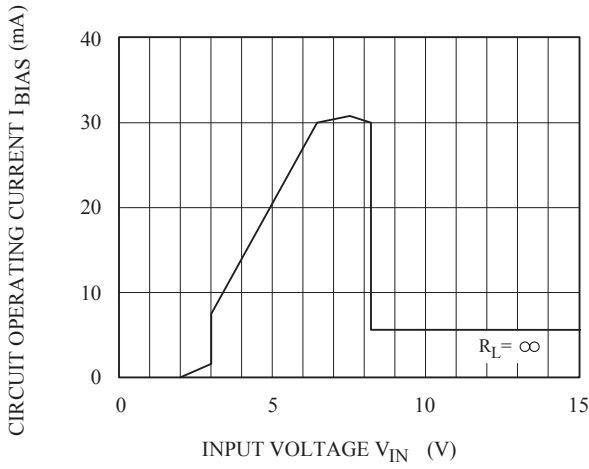

Fig.7-4 $V_{IN} - I_{BIAS}$ (KIA78R09)

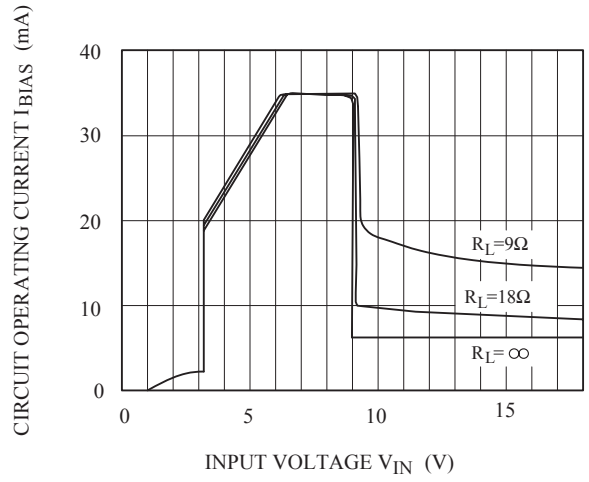

Fig.7-5 $V_{IN} - I_{BIAS}$ (KIA78R10)

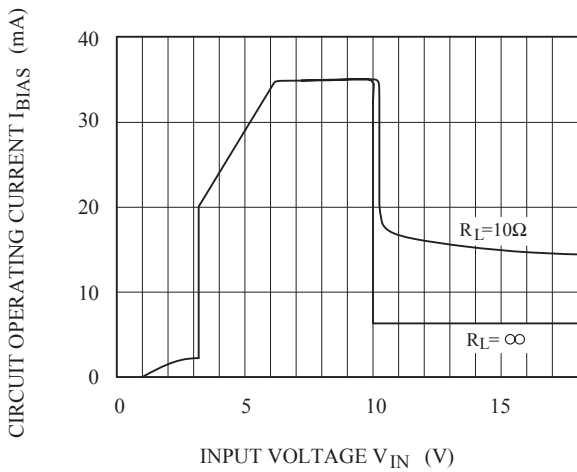

Fig.7-6 $V_{IN} - I_{BIAS}$ (KIA78R12)

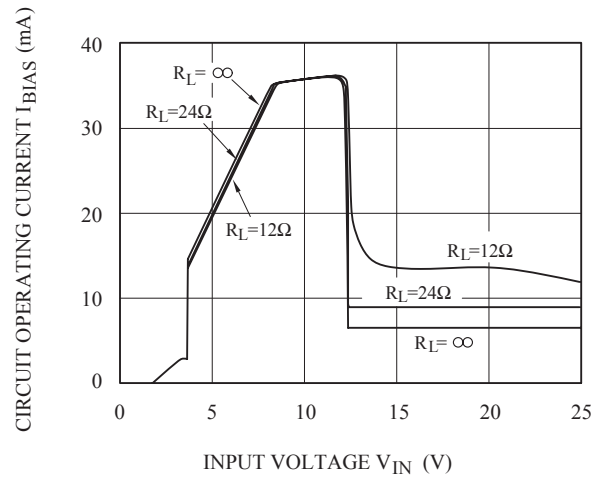

Fig.7-7 $V_{IN} - I_{BIAS}$ (KIA78R15)

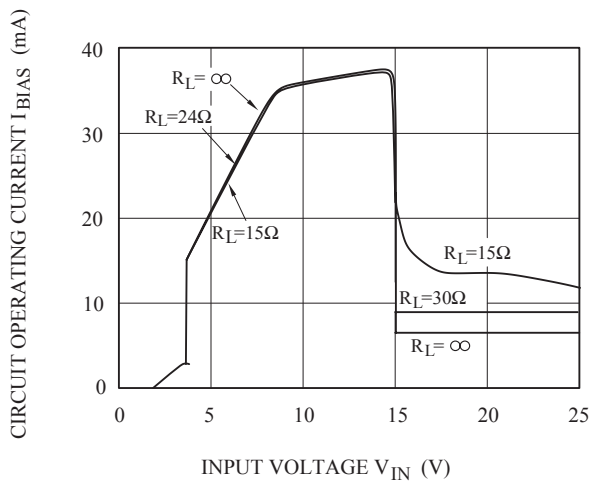
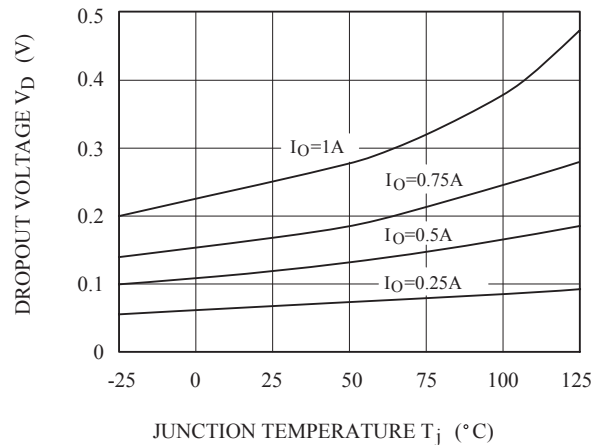

Fig.8 $T_j - V_D$



KIA78R05API~KIA78R15API

Fig.9 $T_j - I_q$

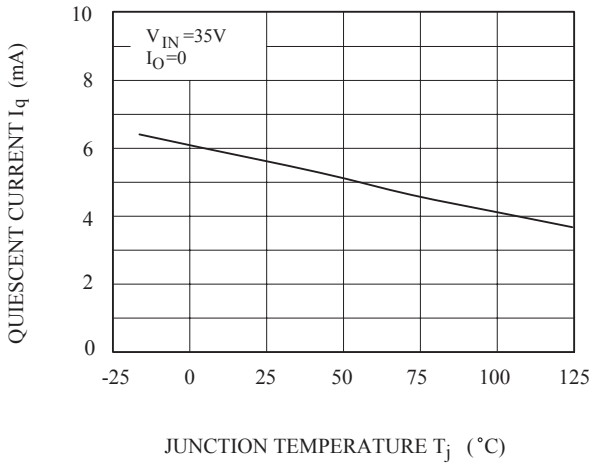

Fig. 10-1 $f - RR$

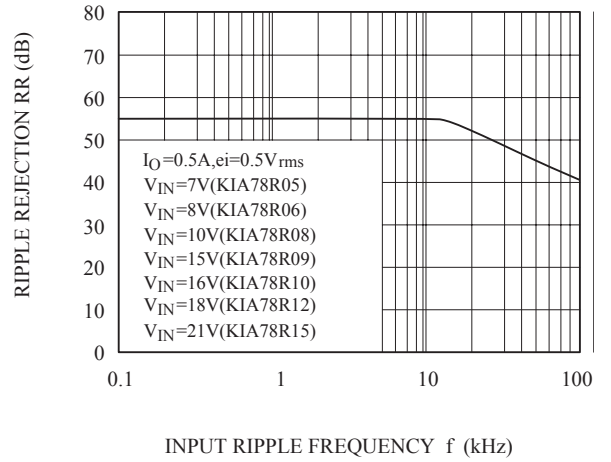

Fig.10-2 $I_O - RR$

