

TOSHIBA Field Effect Transistor Silicon N Channel MOS Type (High speed U-MOS III)

# TPC8013-H

High Speed and High Efficiency DC-DC Converters  
 Notebook PC Applications  
 Portable Equipment Applications

- Small footprint due to small and thin package
- High speed switching
- Small gate charge:  $Q_g = 48 \text{ nc}$  (typ.)
- Low drain-source ON resistance:  $R_{DS(ON)} = 5.4 \text{ m}\Omega$  (typ.)
- High forward transfer admittance:  $|Y_{fs}| = 25 \text{ S}$  (typ.)
- Low leakage current:  $I_{DSS} = 10 \text{ }\mu\text{A}$  (max) ( $V_{DS} = 30 \text{ V}$ )
- Enhancement-mode:  $V_{th} = 1.1 \text{ to } 2.3 \text{ V}$  ( $V_{DS} = 10 \text{ V}$ ,  $I_D = 1 \text{ mA}$ )

## Maximum Ratings ( $T_a = 25^\circ\text{C}$ )

Characteristics		Symbol	Rating	Unit
Drain-source voltage		$V_{DSS}$	30	V
Drain-gate voltage ( $R_{GS} = 20 \text{ k}\Omega$ )		$V_{DGR}$	30	V
Gate-source voltage		$V_{GSS}$	$\pm 20$	V
Drain current	DC (Note 1)	$I_D$	15	A
	Pulse (Note 1)	$I_{DP}$	60	
Drain power dissipation ( $t = 10 \text{ s}$ ) (Note 2a)		$P_D$	1.9	W
Drain power dissipation ( $t = 10 \text{ s}$ ) (Note 2b)		$P_D$	1.0	W
Single pulse avalanche energy (Note 3)		$E_{AS}$	146	mJ
Avalanche current		$I_{AR}$	15	A
Repetitive avalanche energy (Note 2a) (Note 4)		$E_{AR}$	0.19	mJ
Channel temperature		$T_{ch}$	150	$^\circ\text{C}$
Storage temperature range		$T_{stg}$	-55 to 150	$^\circ\text{C}$

Note: For (Note 1), (Note 2), (Note 3) and (Note 4), please refer to the next page.

This transistor is an electrostatic sensitive device. Please handle with caution.

Unit: mm

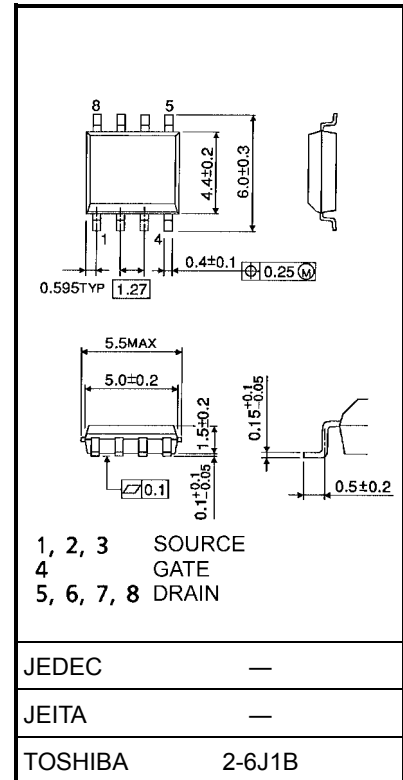

Weight: 0.080 g (typ.)

## Circuit Configuration

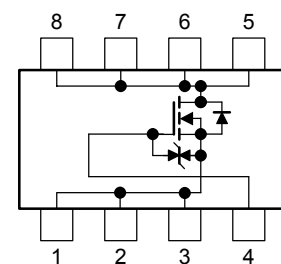

## Thermal Characteristics

Characteristics	Symbol	Max	Unit
Thermal resistance, channel to ambient (t = 10 s) (Note 2a)	$R_{th(ch-a)}$	65.8	°C/W
Thermal resistance, channel to ambient (t = 10 s) (Note 2b)	$R_{th(ch-a)}$	125	°C/W

## Marking (Note 5)

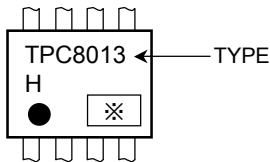

Note 1: Please use devices on condition that the channel temperature is below 150°C.

Note 2: (a) Device mounted on a glass-epoxy board (a) (b) Device mounted on a glass-epoxy board (b)

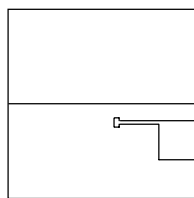

(a)

FR-4  
25.4 × 25.4 × 0.8  
(unit: mm)

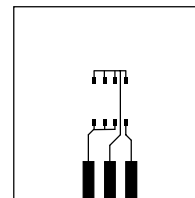

(b)

FR-4  
25.4 × 25.4 × 0.8  
(unit: mm)

Note 3:  $V_{DD} = 24\text{ V}$ ,  $T_{ch} = 25^\circ\text{C}$  (initial),  $L = 0.5\text{ mH}$ ,  $R_G = 25\ \Omega$ ,  $I_{AR} = 15\text{ A}$

Note 4: Repetitive rating: pulse width limited by max channel temperature

Note 5: • on lower left of the marking indicates Pin 1.

※ shows lot number. (year of manufacture: last decimal digit of the year of manufacture, month of manufacture: January to December are denoted by letters A to L respectively.)

## Electrical Characteristics (Ta = 25°C)

Characteristics		Symbol	Test Condition	Min	Typ.	Max	Unit
Gate leakage current		$I_{GSS}$	$V_{GS} = \pm 16\text{ V}, V_{DS} = 0\text{ V}$	—	—	$\pm 10$	$\mu\text{A}$
Drain cut-OFF current		$I_{DSS}$	$V_{DS} = 30\text{ V}, V_{GS} = 0\text{ V}$	—	—	10	$\mu\text{A}$
Drain-source breakdown voltage		$V_{(BR)DSS}$	$I_D = 10\text{ mA}, V_{GS} = 0\text{ V}$	30	—	—	V
		$V_{(BR)DSX}$	$I_D = 10\text{ mA}, V_{GS} = -20\text{ V}$	15	—	—	
Gate threshold voltage		$V_{th}$	$V_{DS} = 10\text{ V}, I_D = 1\text{ mA}$	1.1	—	2.3	V
Drain-source ON resistance		$R_{DS(ON)}$	$V_{GS} = 4.5\text{ V}, I_D = 7.5\text{ A}$	—	6.6	9.5	$\text{m}\Omega$
			$V_{GS} = 10\text{ V}, I_D = 7.5\text{ A}$	—	5.4	6.5	
Forward transfer admittance		$ Y_{fs} $	$V_{DS} = 10\text{ V}, I_D = 7.5\text{ A}$	12.5	25	—	S
Input capacitance		$C_{iss}$	$V_{DS} = 10\text{ V}, V_{GS} = 0\text{ V}, f = 1\text{ MHz}$	—	2380	—	pF
Reverse transfer capacitance		$C_{rss}$		—	410	—	
Output capacitance		$C_{oss}$		—	980	—	
Switching time	Rise time	$t_r$	<p><math>V_{GS} = 10\text{ V}</math> <math>0\text{ V}</math> <math>I_D = 7.5\text{ A}</math> <math>V_{OUT}</math> <math>4.7\Omega</math> <math>R_L = 2\Omega</math> <math>V_{DD} \approx 15\text{ V}</math> Duty <math>\leq 1\%</math>, <math>t_w = 10\mu\text{s}</math></p>	—	9.8	—	ns
	Turn-ON time	$t_{on}$		—	21	—	
	Fall time	$t_f$		—	15	—	
	Turn-OFF time	$t_{off}$		—	60	—	
Total gate charge (gate-source plus gate-drain)		$Q_g$	$V_{DD} \approx 24\text{ V}, V_{GS} = 10\text{ V}, I_D = 15\text{ A}$	—	46	—	nC
			$V_{DD} \approx 24\text{ V}, V_{GS} = 5\text{ V}, I_D = 15\text{ A}$	—	26	—	
Gate-source charge 1		$Q_{gs1}$	$V_{DD} \approx 24\text{ V}, V_{GS} = 10\text{ V}, I_D = 15\text{ A}$	—	7.2	—	
Gate-drain ("miller") charge		$Q_{gd}$	$V_{DD} \approx 24\text{ V}, V_{GS} = 10\text{ V}, I_D = 15\text{ A}$	—	12.2	—	
Gate switch charge		$Q_{sw}$	$V_{DD} \approx 24\text{ V}, V_{GS} = 10\text{ V}, I_D = 15\text{ A}$	—	15.6	—	

## Source-Drain Ratings and Characteristics (Ta = 25°C)

Characteristics		Symbol	Test Condition	Min	Typ.	Max	Unit
Drain reverse current	Pulse (Note 1)	$I_{DRP}$	—	—	—	60	A
Forward voltage (diode)		$V_{DSF}$	$I_{DR} = 15\text{ A}, V_{GS} = 0\text{ V}$	—	—	-1.2	V

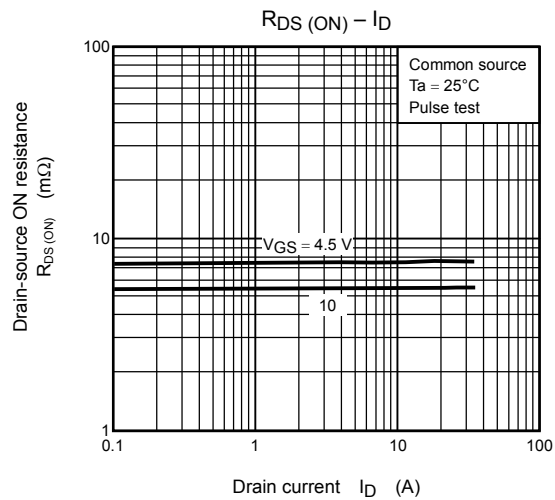
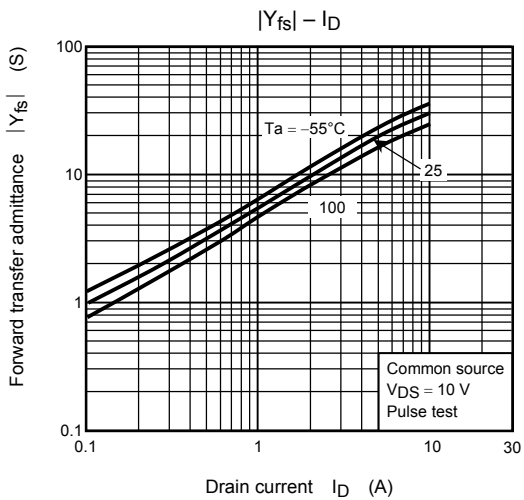
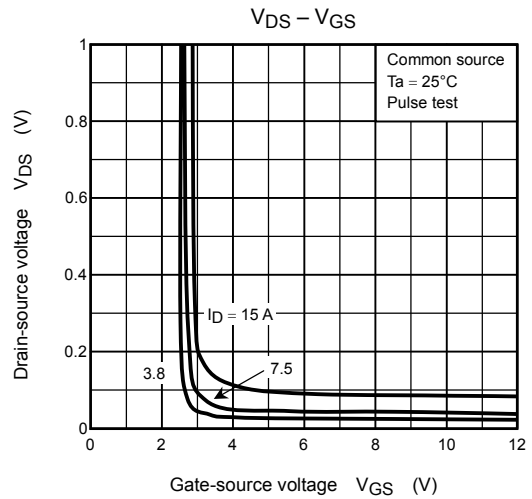
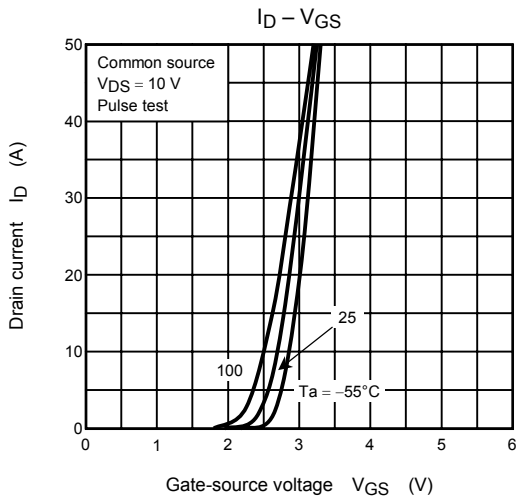
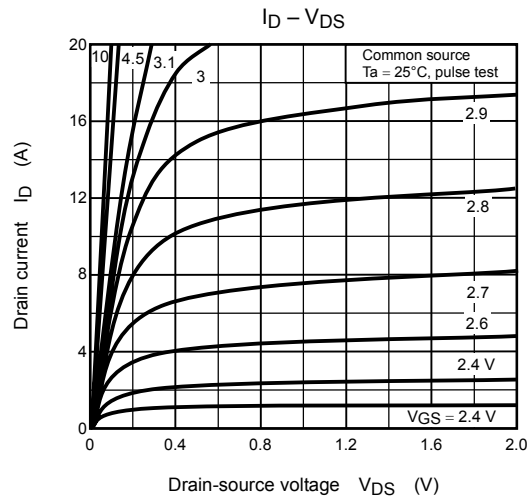
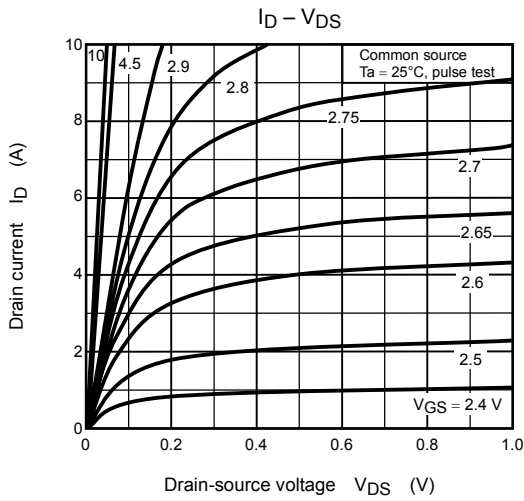

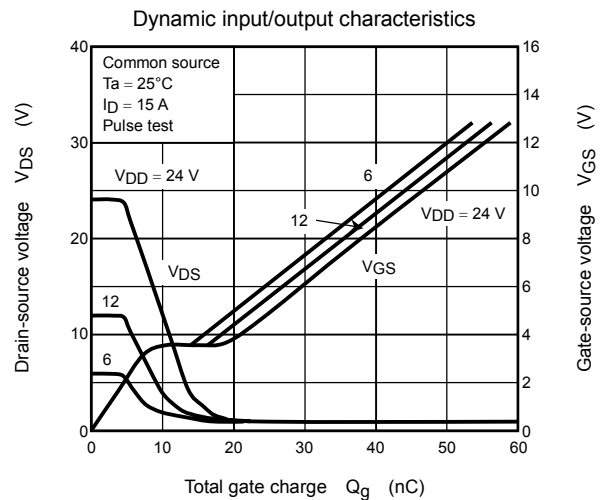
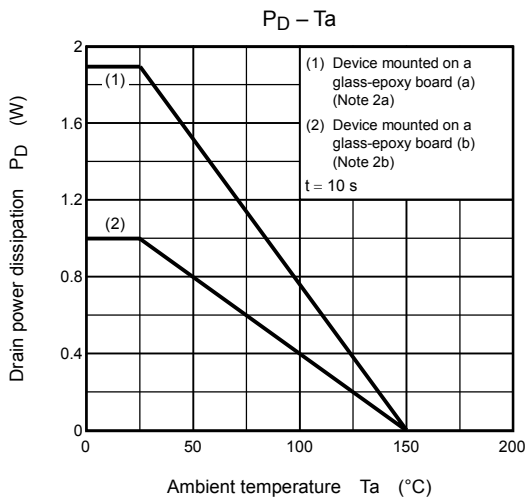
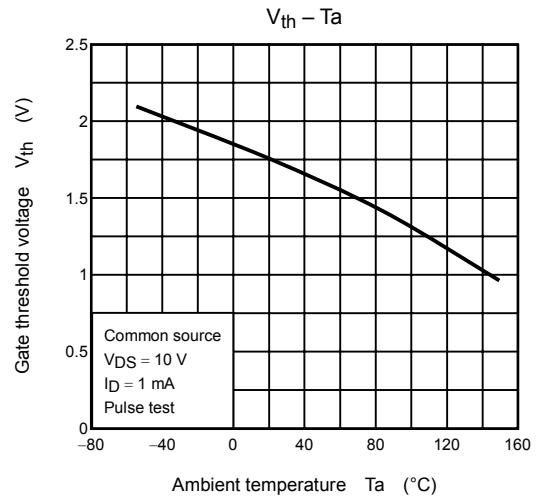
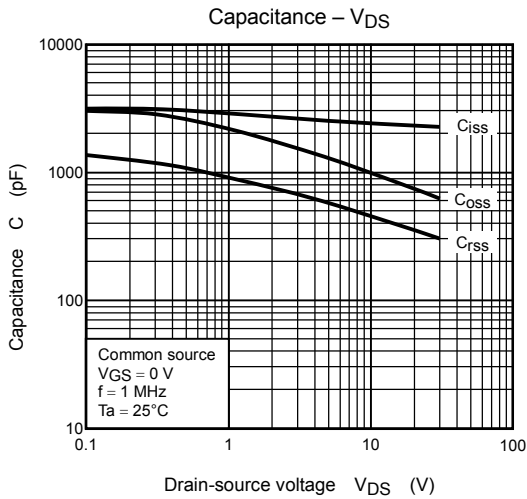
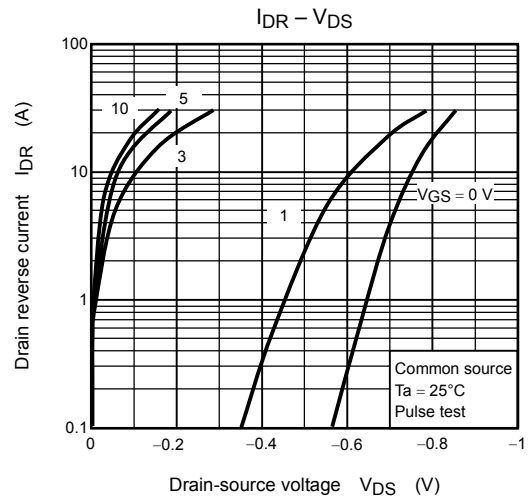
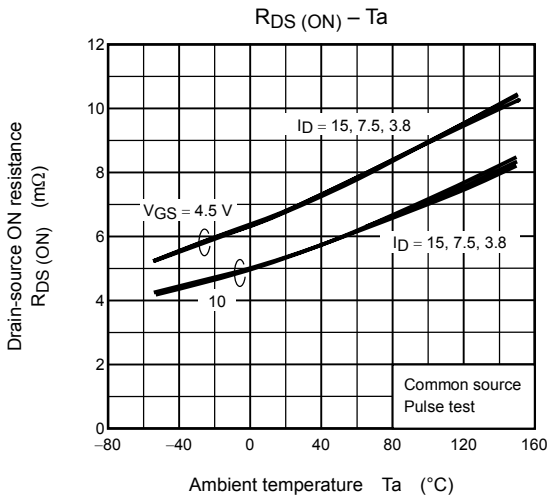

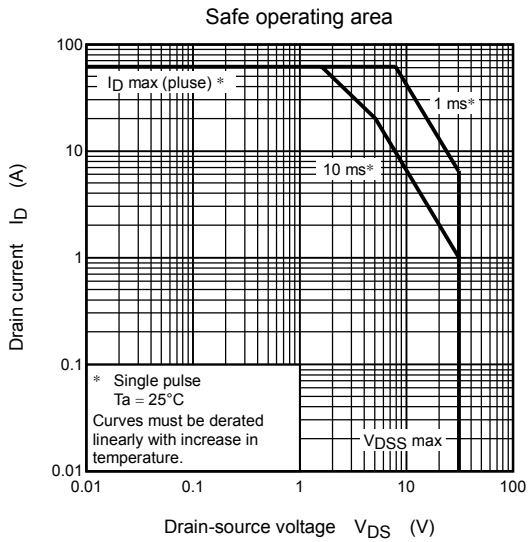
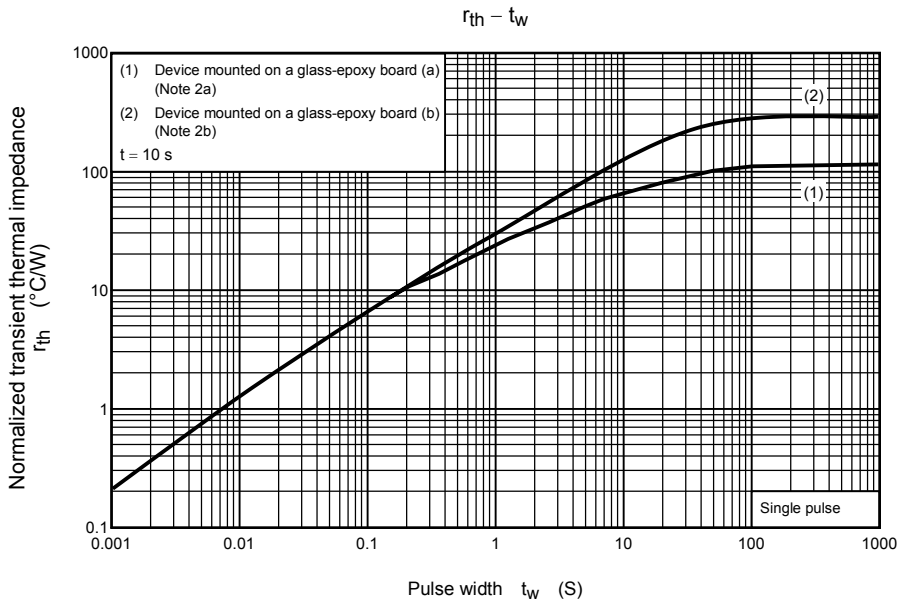

**RESTRICTIONS ON PRODUCT USE**

000707EAA

- TOSHIBA is continually working to improve the quality and reliability of its products. Nevertheless, semiconductor devices in general can malfunction or fail due to their inherent electrical sensitivity and vulnerability to physical stress. It is the responsibility of the buyer, when utilizing TOSHIBA products, to comply with the standards of safety in making a safe design for the entire system, and to avoid situations in which a malfunction or failure of such TOSHIBA products could cause loss of human life, bodily injury or damage to property.  
In developing your designs, please ensure that TOSHIBA products are used within specified operating ranges as set forth in the most recent TOSHIBA products specifications. Also, please keep in mind the precautions and conditions set forth in the "Handling Guide for Semiconductor Devices," or "TOSHIBA Semiconductor Reliability Handbook" etc..
- The TOSHIBA products listed in this document are intended for usage in general electronics applications (computer, personal equipment, office equipment, measuring equipment, industrial robotics, domestic appliances, etc.). These TOSHIBA products are neither intended nor warranted for usage in equipment that requires extraordinarily high quality and/or reliability or a malfunction or failure of which may cause loss of human life or bodily injury ("Unintended Usage"). Unintended Usage include atomic energy control instruments, airplane or spaceship instruments, transportation instruments, traffic signal instruments, combustion control instruments, medical instruments, all types of safety devices, etc.. Unintended Usage of TOSHIBA products listed in this document shall be made at the customer's own risk.
- The information contained herein is presented only as a guide for the applications of our products. No responsibility is assumed by TOSHIBA CORPORATION for any infringements of intellectual property or other rights of the third parties which may result from its use. No license is granted by implication or otherwise under any intellectual property or other rights of TOSHIBA CORPORATION or others.
- The information contained herein is subject to change without notice.